

BBC MICRO·MASTER·ELECTRON·ATOM

£1.25

ACORN USER

SEPTEMBER 1986

BIGGEST AND BEST-SELLING BBC/ACORN MAGAZINE

MASTER 512:
We test for IBM
compatibility

SIDEWAYS RAM:
Beat the BBC
memory barrier

PRINTERS:
Putting your
screens on paper

MICRO POWER:
32016 add-on
packs punch

TYPE DESIGNER:
Stylish letters
by numbers

MAZE GAME

Get out of this
one if you can!

50th ISSUE:
Free software
page 7



LABORATORY WORKSTATION FOR YOUR COMPUTER

Professional instrumentation with the I40I intelligent laboratory interface

Compatible with the BBC model B, B+ and the new Master range, and all the Acorn second processors.

- Full 12 bit analogue input and output
- Up to 2 Mbytes of internal memory
 - Multi-tasking operation
 - Full laboratory software – including FFTs – is included
- Application programs including Spectrum Analyser, Signal Averager, PSTH and INTH.

Designed and made in Cambridge, England

It runs just as fast with the Apple, Apricot, HP, IBM or Nimbus too!

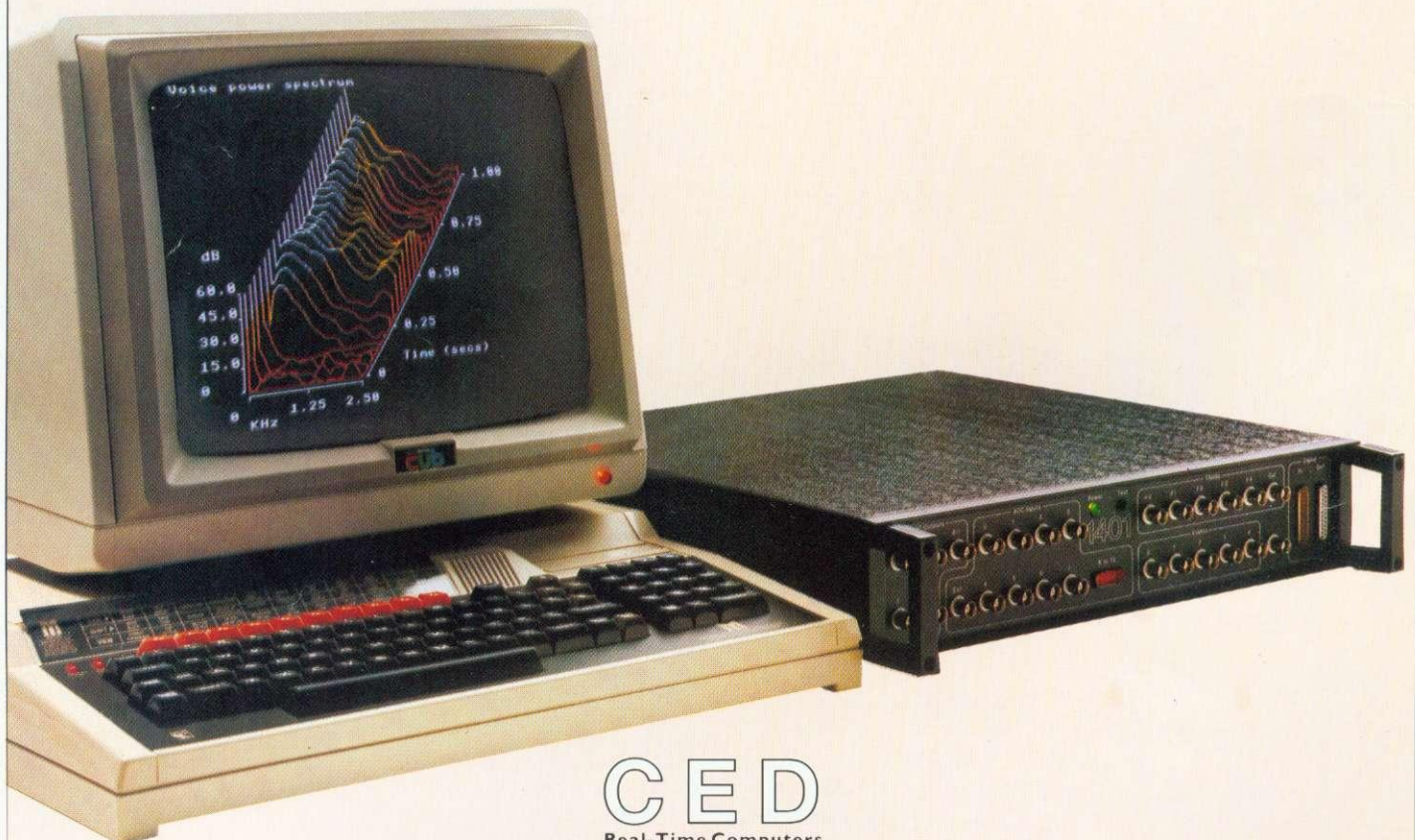

CED
Real-Time Computers

Science Park, Milton Road, Cambridge CB4 4FE. Tel Cambridge (0223) 316186

MICRO MEDIA

0707 52698 or 0707 50913

Computer Supplies

Rydal Mount, Baker Street,
Potters Bar, Herts EN6 2BP

UNBRANDED 5 1/4" DISCS

Certified lifetime warranty
hub rings, envelopes, labels
Prices per 10 Discs 10+ 30+

Tracks	10+	30+
SS/DD 40	7.50	6.80
DS/DD 40	9.00	8.20
DS/DD 80	9.50	8.70

3M 5 1/4" Lifetime Guarantee		
SS/DD 40	11.90	11.00
DS/DD 40	14.00	13.20
SS/DD 80	17.50	15.50
DS/DD 80	18.70	16.50

3M 3 1/2" TPI		
SS/DD 135	21.90	18.50
DS/DD 135	30.20	25.50

COMPUTER LABELS

Continuous fanfold sprocket fed	Price per 1000	1,000	2,000+
70 x 36	4.40	4.00	
89 x 36	4.50	4.10	
89 x 49	6.20	5.70	
102 x 36	4.70	4.40	

Please state no of labels across sheets (1 2 or 3)

9 1/2" BACKING SHEET FOR FIXED TRACTOR

	PRICE PER 1000
70 x 36 3 across	4.00
89 x 36 2 across	6.60
102 x 36 2 across	6.70

ENVELOPES

	Boxed	Price per box
110 x 220 4 1/4 x 8 5/8 White Self seal 90gsm	500	11.90
Manilla Banker Gummed 70gsm	500	9.90
Bond 324x229 12 3/4" x 9" Manilla self seal 90gsm	250	17.90

COMPUTER PAPER

Plain, fanfold, micro perf edges

Size	Weight 1000s gsm	per Bx	Price per box 1 box	2 Bxs+
11 x 9 1/2	60	2	13.00	12.20
	80	2	16.20	14.60
EXACT A4	70	2	21.50	18.90
11 1/2 x 9 1/4	90	1	13.70	11.50
EXACT A4 Fixed Tractor Feed				
11 1/2 x 9 1/2	80	1	16.75	14.20
	100	1	29.00	27.50

PRINTER LEAD

Centronics lead to connect BBC to EPSON KAGA CANON etc

1 mtr -	6.50
2 mtr -	8.50

SWIVEL BASES FOR MONITORS

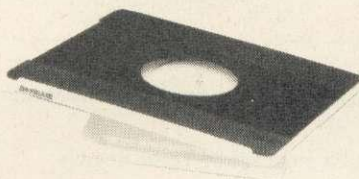

Pan tilt revolves around 360°
12.5° tiltable up and down
Adjustable by inside screw.

12" MONITORS	£14.00
14" MONITORS	£17.50

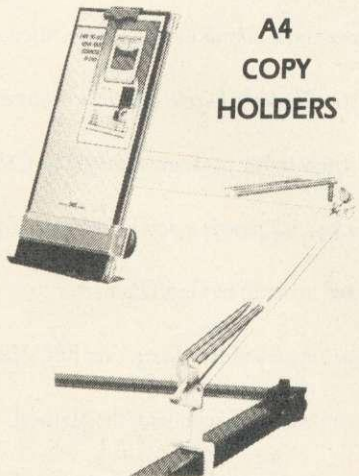

A4 COPY HOLDERS

Adjustable with arm
Desktop £19.80
£13.00

Magnifying cursor line
Paper height adjustable clip
Paper thickness adjustment

PRINTOUT BINDERS

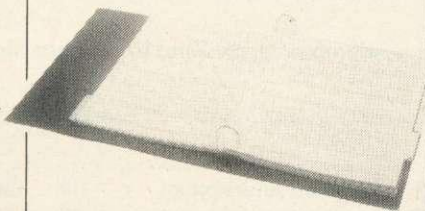

Adjustable hardback ring binder
for 11 x 9 1/2 12 x 9 1/4 con't paper
40mm paper capacity
BLUE RED or BLACK
£4.90 each
set/5 indexes £2.30

PRINTER RIBBONS

Mixed types for quantity breaks, 1 & 2 off's if ordered with other products.

	3+	6+
ACORN AP 80	2.95	2.40
AP100	2.95	2.40
INK JET CART	7.50 per 4	
BROTHER HR 5	3.00	2.80
M1009	3.70	3.20
HR15 MS	3.50	3.00
HR15 Fabric	3.60	3.10
CANON PW1156/1080	3.40	2.90
Red Brown Blue Green	5.30	4.70
CENTRONICS G.L.P.	3.70	3.20
DAISYSTEP 2000 M/S	3.10	2.60
Fabric	4.90	4.20
EPSON FX/MX/RX 80	3.00	2.60
Red Brown Blue Green	4.20	3.50
LX 80	3.00	2.60
Red Brown Blue Green	4.20	3.50
JUKI 6100 MS	2.50	2.10
6100 SS	1.60	1.30
Red Brown Blue	2.50	2.10
2200 Fabric	3.70	3.40
2200 SS	3.10	2.75
2200 corr	4.00	3.60
KAGA KP810/910	3.40	2.90
Red Brown Blue Green	5.30	4.70
M/TALLY MT 80 M/S	4.00	3.20
NEC PC 8023	3.60	3.00
OKI 80/82	1.60	1.30
Red Brown Blue	2.40	2.00
PANASONIC KXP 110	7.50	6.30
QUENDATA 2000 MS	3.10	2.60
Fabric	4.90	4.20
SEIKOSHA GP 80	2.95	2.40
GP 100/250	2.95	2.40
GP 500	3.90	3.30
SHINWA CP 80 M/S	4.00	3.20
SMITH CORONA		
EL 1000/2000 M/S	8.50	7.90
Fabric	3.90	3.60
Correctable	5.00	4.70
STAR GEMINI 10x 15x	1.60	1.30
Red Brown Blue	2.40	2.00
NL 10	5.60	4.90
WALTERS WM80 M/S	4.00	3.20

If the ribbon you require is not listed ring 0707 52698 and let us quote

DISC MAILERS

	Price each	50+	100+
Rigid Cardboard			
holds up to 3 discs	40p		28p



MM 100N
5 1/4 x 100



MM 70L
5 1/4 x 70



MM50L
5 1/4 x 50



MM40L
3 1/2 x 40



Rexel Mini
Disc Box 30.

5 1/4 x 30
Brown smoked
Tilt lid. Cream plastic base



Plastic
Library
Case
5 1/4 x 10

DISC BOXES

MM 100	5 1/4 x 100	11.90
MM 70	5 1/4 x 70	10.90
MM 50	5 1/4 x 50	8.90
MM 40	3 1/2 x 40	8.90
Mini Box Rexel	5 1/4 x 30	5.00
Library Case	5 1/4 x 10	1.50
All MM boxes anti-static with lock.		

DISC CARE

5 1/4" Head Cleaning Disk with 15ml cleaning solution	5.50
---	------

● Educational and HMG orders accepted. ● Trade enquiries. ● Personal callers welcome.



ALL PRICES INCLUSIVE OF POSTAGE & PACKING
Please add VAT at 15%



24-Hour
Credit Card
Orders

0707 52698

MICRO MEDIA - MICRO MEDIA - MICRO MEDIA - MICRO MEDIA -

ACORNUSER

ISSUE No 50 SEPTEMBER 1986

EDITOR
Tony Quinn

TECHNICAL EDITOR
Bruce Smith

SUB-EDITORS
Julie Carman
Shona McIsaac

EDITORIAL SECRETARY
Colette Curley

TECHNICAL ASSISTANTS
David Acton
Benjamin Rietti

ART DIRECTOR
Mike Lackersteen

ART EDITOR
Liz Thompson

ASSISTANT ART EDITOR
Paul Holmes

GROUP ADVERTISEMENT
DIRECTOR
Stefanie Blower

ADVERTISEMENT MANAGER
Simon Goode

SALES EXECUTIVES
Jonathan Rawlins
Thomas Rashid

MERCHANDISING MANAGER
Sarah Bullard

PUBLISHING DIRECTOR
Michael Potter

EDITORIAL DIRECTOR
Christopher Ward

NEW USERS

HINTS AND TIPS:	50
How screen dumps are programmed and more on printer codes by Martin Phillips	
FIRST BYTE:	54
More about machine code and assembly language by Tessie Revivis	

REVIEWS

GAMES:	131
<i>Deathstar, Tennis, Savage Pond, Winter Olympics</i> and <i>Jack Attac</i>	
SOFTWARE:	135
Acornsoft's <i>ViewIndex</i> , Clares' <i>Discdex</i> and <i>Granville</i> by Cambridge Micro Software	
SOFTWARE:	137
Geoff Bains experiments with Addison-Wesley's <i>Digital Electronics</i> course	
SOFTWARE:	139
Jeffery Pike composes himself with a new music package, <i>Musicpen</i> by CNC	
HARDWARE:	141
Mike Jackson reviews Sidewinder, a joystick interface and ROM board for the Electron	
SOFTWARE:	143
The <i>Advanced Disc Investigator</i> reviewed in depth by Geoff Bains	
BOOKS:	149
<i>Programming in Micro-PROLOG Made Simple</i> and <i>Interfacing Your BBC Microcomputer</i>	
HARDWARE:	151
Bill Penfold gets his hands on an unconventional keyboard, the Maltron	
HARDWARE/SOFTWARE:	153
Technical Editor Bruce Smith assesses the Master 512 co-processor	
SOFTWARE:	159
<i>Fontwise</i> gives flexibility to a dot-matrix printer. Review by Patrick Quick	

BUSINESS

BUSINESS NEWS:	161
All the latest information for users of Acorn computers in business	
WORDS OF WISDOM:	164
Useful routines and techniques for wordprocessing, presented by Jacquetta Megarry	

REGULARS

News	7	Magazine subscriptions	108	Order forms	110
Letters	43	Back issues	108	Yellow pages	113
Fontwise offer	92	Disc and magazine binders	108	Software charts	129
Competition	105	Bibliography disc	109	Acorn Forum	166
Barcode reader pack	106	Gallery graphics disc	109	Free ads	173
Sideways RAM offer	106	Special cassettes	109	Small ads	175
Listings cassette and disc	107	UserDump and UserROM	110	Acorn Abuser's Diary	176

Subscriptions: Contact Christine Allen, Redwood Publishing Ltd, Lambourn Woodlands, Newbury, Berks. Tel: (0672) 40888. UK £17.50; Europe £25; Middle East £30; Americas, Africa £35; rest of the world £40 (prices include p&p for 12 issues). Published by Redwood Publishing Ltd, 141-143 Drury Lane, London WC2B 5TF. Tel: 01-836 2441. Printed by Watmoughs Ltd, Bradford. Typesetting and colour reproduction by Publishers Reprographic Services, London. Print production by Aquarius Print and Design, London. Distributed to the news trade by Comag, Tavistock Road, West Drayton, Middlesex UB7 7QE.



FEATURES

A-MAZE-ING

88

First find the treasure – then find your way out of the maze with David Lawrence's addictive game

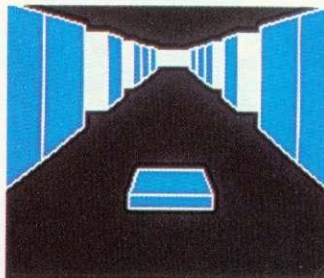

ACORN'S SUPERCOMPUTER

145

The 32016 second processor is a powerful tool for colleges and universities: review by Peter Voke



ON THE MENU

81

Joe's Jottings, in which the estimable Mr Telford explains how to develop useful screen menus for all occasions



CLEVER CALLIGRAPHY

93

Mike Turner's programs enable you to design your own ornamental lettering for a dot-matrix printer

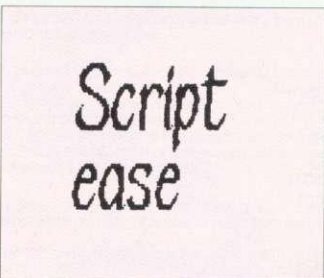

JOY FOR ELECTRON USERS

141

Mike Jackson reviews the Sidewinder, a joystick interface and ROM board for the Electron



COVER



Cover illustration by John Clementson

NEXT MONTH

NEXT?

Amid all the rumours, we look at Acorn's future micro plans.

Spider curve plotter – for those awkward equations.

Wordprocessors for kids.

The secrets of Viewspell.

Turtle treats: get the most out of Logo.

THE ULTIMATE UTILITY FOR YOUR COMPUTER

SPEECH!

**NO EXTRA HARDWARE
REQUIRED**

**AS REVIEWED ON
BBC TV**

**FOR THE
COMMODORE
AMSTRAD AND
BBC COMPUTERS**

COMMODORE 64/128

Cassette **£9.95**

Disc **£11.95**

AMSTRAD CPC464/664/6128

Cassette **£9.95**

Disc **£14.95**

BBC MICROS: B, B+, Master

Cassette **£9.95**

Disc **£11.95**

**THE RECENTLY RELEASED BBC MICRO
VERSION HAS BEEN GREETED WITH
ACCLAIM AND INCREDULITY.—**

At last, speech synthesis at a price you can afford. SPEECH! works entirely in software taking up less than 9K of RAM: no extra hardware whatsoever is required. Unlike other systems, SPEECH! has an unlimited vocabulary: it will say anything you want it to, and is simplicity itself to use. Simply type in: ***SAY I AM A TALKING COMPUTER, AS EASY TO USE AS 1 2 3...** and the computer speaks.

SPEECH! has a built-in parser which translates English words into "phonemes", or speech particles. There are 49 phonemes and 8 different pitch settings which can be used directly by the *SPEAK command (e.g. *SPEAK/HEH4LOW4) so stress or intonation can easily be added wherever desired. You can change the overall pitch with the *PITCH command.

Every copy of SPEECH! comes complete with extra software:

- DEMO — shows off all the features,
- SPELL — an innovative educational program,
- SAYFILE — speaks the lines of your programs.

Applications in:

- games
- education
- business
- utilities

REVIEWS ON BBC-1 AND BBC-2 TV

Saturday Superstore (BBC-1)

"This is knockout! This is great! ... Wonderful! Very, very clever." ... Fred Harris

Micro Live (BBC-2)

"Really good value!" ... John Coll

REVIEWS IN THE COMPUTER PRESS

"The reproduction is surprisingly good, and certainly on a par with some of the more expensive speech interfaces I have heard. An excellent low cost speech synthesiser that really is very good value for money." ... ACORN USER

"... incredibly easy to use. The end result is as good as anything I've heard this side of the Amiga." ... POPULAR COMPUTING WEEKLY

"Overall an excellent package" ... MICRONET 800.

"This is one utility which cannot be beaten on quality or price" ... The MICRO USER.

"SPEECH! from Superior Software is a truly remarkable offering. A rare gem indeed. Superior Software has produced a price breakthrough by achieving an apparent technical impossibility." ... A & B COMPUTING.

OUR GUARANTEE

- All mail orders are despatched within 24 hours by first-class post.
- Postage and packing is free.
- Faulty cassettes and discs will be replaced immediately.



24 HOUR TELEPHONE ANSWERING SERVICE FOR ORDERS

**SUPERIOR
SOFTWARE**
Limited

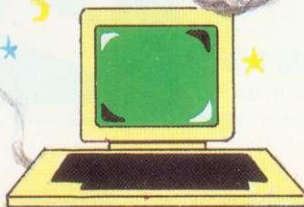

Dept. SP2, Regent House, Skinner Lane, Leeds LS7 1AX. Telephone: 0532 459453

WE PAY TOP ROYALTIES FOR HIGH QUALITY SOFTWARE

SPEECH!

was greeted with admiration and acclaim by the computer press

(for the BBC Micro)

“ Overall an excellent package.

Value for Money	5
Presentation	5
Use of Machine	5
Ease of Use	4
Facilities	5
Effectiveness	4
Total Score out of 30: 28	”

MICRONET 800, December 1985

“ Superior Software's SPEECH! is a quite remarkable piece of programming. The program takes up 7½ K of program space and is incredibly easy to use. It merely requires a new command word which is SAY preceded by a *. The end result is as good as anything I've heard this side of the Amiga and it'll make a stab at even the most ludicrous words constructed without vowels and at great length. It is

possible to add words to the computer dictionary where they are not said exactly as they would be, using phoneme analysis and also to vary the pitch of the spoken voice. Why pay more? ”

Popular Computing Weekly, 19-25 December 1985.

“ The reproduction is suprisingly good and certainly on a par with some of the more expensive speech interfaces I have heard. All in all, an excellent low cost speech system that really is very good value for money. ”

Bruce Smith, Acorn User, February 1986.

“ SPEECH! from Superior Software is a truly remarkable offering. A rare gem indeed among the morass of mediocre to competent efforts which dominate a reviewer's postbag. In my view SPEECH! is an absolute breakthrough for the BBC micro which deserves to sell by the thousand. Superior Software has produced a price breakthrough by achieving an apparent technical impossibility. David Hoskins, the programmer, has cleverly programmed the sound chip to do things which its designers never intended it to do. A most practical application example also provided is a spelling checker. This has

always been a problem case for educational software — how to test spellings without printing the word and revealing all. This program is well designed and effective and users are encouraged to customise it with their own examples. In short, SPEECH! is a very clever and useful program being offered at a silly price. If you were planning to buy another arcade game, take my advice and spend the money on SPEECH! instead. ”

Jonathan Evans, A & B Computing, March 1986.

“ SPEECH! is the most talked-about package ever created for the BBC Micro. For the first time it endows your micro with the power of speech for an incredibly low price. ”

Christopher Payne, The Micro User, April 1986.

“ If I were a manufacturer of a speech synthesis product I would be greatly worried by the arrival of SPEECH! This is one utility that cannot be beaten on quality or price. ”

SOUND	9
GRAPHICS	n/a
EASE OF USE	9
VALUE FOR MONEY	9
OVERALL	9

James Riddell, The Micro User, June 1986



COMPETITION COMPETITION COMPETITION COMPETITION

THE QUIZ

1. In which year did Superior Software release their first software cassette?
2. Can a computer be manufactured without using integrated circuits or transistors?
3. Which U.K. company manufactured the coin-operated arcade machine of the successful game Hunchback?
4. Name the author of Superior Software's SPEECH! program?
5. What was the name of the acclaimed home computer sold by Commodore before they produced the Commodore-64?
6. Which Superior Software game won the "Computer Gamer" Game of the Year Award for the Best BBC Game of 1985?
7. Name the Managing Director of Amstrad Consumer Electronics PLC?
8. Which of the following is not a valid phoneme representation as used in Superior Software's SPEECH!
EE UH C M NX ZH
9. What does the acronym ASCII stand for?
10. How do you spell the word "azure" phonetically in order to be pronounced correctly by the *SPEAK command of Superior Software's SPEECH! program?

Describe the most useful application of SPEECH! that you can envisage. (Please write your description on a separate sheet using more than 50 words, but not more than 200 words).

HOW TO ENTER

To enter, simply complete the 10-question quiz (on the left), and describe what you think is the most useful application for SPEECH! The completed entry form should be sent to Superior Software at the address given below.

THE PRIZES

Each entrant who answers the 10 question quiz correctly will receive a colourful SPEECH! badge (pictured left). All correct entrants will then be considered for the main prize of a pair of professional walkie-talkies (valued at £200), a trophy, and the cash prize of £100. The winner of this prize will be determined at the close of the competition on 31st January, 1987. The winner will be the person who has correctly completed the 10 question quiz and, in the opinion of the judges, describes the most useful application of Superior Software's SPEECH! program.

RULES

1. All entries must be accompanied by a completed entry form and a description (on a separate sheet) of what, in your opinion, is the most useful application of SPEECH!
2. All entries must clearly show the sender's name, address and age (if under 18), and should be addressed to: "SPEECH! Competition", Superior Software Ltd, Regent House, Skinner Lane, Leeds LS7 1AX.
3. The closing date for receiving entries to the competition is 31st January 1987.
4. The company's decision is final and no correspondence can be entered into.
5. The competition is not open to the employees of Superior Software Ltd, the authors of SPEECH! their agents or their families.

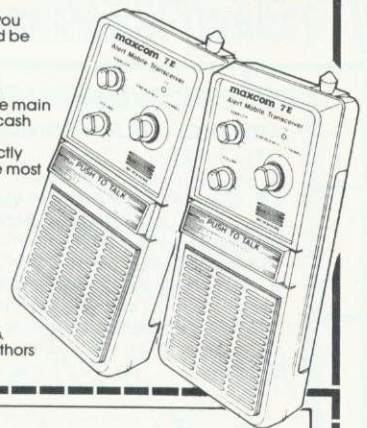

1	6
2	7
3	8
4	9
5	10

Name _____ Age (if under 18) _____

Address _____

Telephone _____

16k EPROM
Advanced Disc Toolkit
containing over 30 commands

Advanced Computer Products

Advanced Computer Products
6 Ava House, High Street,
Chobham, Surrey GU24 8LZ
(0276) 76545

ADVANCED DISC TOOLKIT

(01) /M/B/E

£34.50

Any Acorn user including Master, BBC B+, Electron, DFS, 1770 DFS, ADFS, 2nd. & co-processors A.C.P.'s BEST SELLING product containing over 30 commands inc.: - powerful memory & disc editor, search memory/disc/basic, catalogue/unplug ROMS, load/run programs below page, automatic menu, file transfer (inc. locked cassette files), ADFS utils etc. etc. ("it's superb" ... Database Pubs. - "excellent value for money" ... Acorn User) (16K EPROM & FULL MANUAL)

ADVANCED ROM ADAPTOR 2

(03) /M/E+1/

£14.95

An Acorn approved cartridge containing a card with special 'zero' profile sockets that allow you to fit compatible 8K or 16K EPROMS/ROMS. The cartridge is fully enclosed providing complete protection for your ROMS. Simple to use -no switching-complies fully to the Acorn (sideways) Rom Filing System. A.R.A.2 contains 2 sockets.... A single adaptor is also available.... A.R.A.1 (02) /E/ £10.35

ADVANCED SIDEWAYS RAM

(04) /E+1/

£29.90

A highly versatile but simple to use s/w RAM cartridge that is automatically write protected on loading. Contains 16K RAM but can be switched (externally) to 2 X 8K RAM. Supplied with instructions & full software support (on cassette) to save ROM images to disc/tape, load RAM from file, Advanced Print Buffer & MakeRom a utility to merge several files from disc to be run from the ROM FS. (S/Ware on disc: please add ... £1 5/4 DFS .. £2 3/2 ADFS)

ADVANCED ELECTRON DFS

(05) /E/

£24.15

Electron & Plus 3 users ... gain BBC compatibility by adding the Advanced Electron DFS (1770 DFS) this is the same disc filing system supplied with the BBC B+. Now you can produce and access (compatible) BBC disc based software. A.C.P. also supplies 5/4" disc drives to add to your Plus 3 (inc. 2nd. drive adaptor). "ACP has produced another superb ROM for the Electron" ... Electron User Feb '86 (supplied on 16K EPROM + DFS MANUAL)

ADVANCED DISC INVESTIGATOR

(06) /M/B/E/

£28.75

A very powerful Disc utility for standard & non-standard discs. Backup most protected discs, edit any type of non-standard disc, check & repair faulty tracks, create new disc formats, copy 40track discs to 80track discs, verify two non-standard discs. ("ADI features an extremely comprehensive sector editor, and one of the finest I've seen" ... Tublink on Prestel) (supplied on 16K EPROM + manual)

ADVANCED ROM MANAGER

(07) /M/B/E/

£14.95

A friendly utility for ROM & sideways RAM. Examine ROM/RAMS, load files into RAM, move memory to/from Sways ROM/RAM, catalogue/kill ROMS, offer commands to specific ROMS, save ROMS to disc/tape, AUTOROM a file (inc. BASIC) to run from Sways ROM/RAM, execute specific machine code subroutine in a ROM, generate a ROM's checksum & CRC. *ON ALL ORDERS RECEIVED AFTER 29TH AUGUST* (supplied on EPROM + manual)

ADVANCED PLUS 4

(08) /E+1/

£79.98

"DISC DRIVE COMPATIBILITY AT LONG LAST" ... (Electron User June '86) this sums up AP4 & ACP's approach to producing products. AP4 is a fully ACORN compatible disc I/face & will accept any standard drive inc. PSU, runs 1770 DFS (as fitted in the B+ & Master), keeps page & E00, utils in ROM & provides a spare rom socket. "ACP's PLUS 4 comes out on top. I can recommend it to anyone..." (E.U. June '86) ... AP4 should be considered the standard interface for the Electron (AU July '86) AP4 100 £198.97 (inc VAT & delivery) AP4 400 £228.98 (inc VAT & delivery)

ADVANCED PLUS 5

(09) /E+1/

£66.70

A triple interface cartridge providing...
1) a TUBE i/face allowing a second processor to be connected, increasing BOTH speed & memory (PAGE & 800 HIMEM & 8000 in all modes)
2) a 1 MHz BUS for control applications & prommers
3) the USER PORT for mouse and graphic devices.
Also contains 2/3 ROM sockets and on board operating software for 2nd processor.

ADVANCED 1770 DFS

3 versions ADM (11) - ADB (12)

ADE (13)

£34.50

ACP have totally re-written the Acorn 1770 DFS, enhancing existing features & adding new ones. The result is probably the fastest & most powerful disc filing system your computer could have. With the ability to operate in double density occupying both sides of a disc (640K). Automatic file relocation, improved file handling, 62 file catalogue and Sways RAM can be used as a fast RAM DISC. (16K EPROM + comprehensive manual)

ADVANCED ELECTRON DFS E00

(14) /E+ASR/

£19.99

An alternative to our AED(05) for Plus 3 and ASR users. This optional alternative DFS is designed for use in Sideways RAM (ASR) and allows the user to operate a disc filing system & E00 when using the Plus 3 (in ADFS page would normally be & 1D00). The DFS is simply loaded using the software supplied with the ASR from disc. (optional upgrade for existing AED users £9.50 on return of original EPROM) (3 1/2" ADFS disc + manual)

OTHER PRODUCTS & SPECIAL OFFERS

VIEW cartridge (101) /E+1/	£15.00	3 1/2" discs in 1/box (120) /M/B/E/	£24.00
Vsheet " (102) /E+1/	£15.00	5 1/4" discs ds/dd "(121) /M/B/E/	£12.99
VIEW & VSHEET (119) /E+1/	£25.00	5 1/4" discs ss/sd (122) /M/B/E/	£ 8.99
LISP cartridge (103) /E+1/	£ 9.99	3 1/2" disc drives (please call for price)	
E/Adv User Guide(104) /E/	£ 4.95	5 1/4" disc drives (please call for price)	
TURTLEgrhpCASS(105) /E/	£ 3.99	2nd. Drive Adaptor(130) /E+3/	£ 7.95
LOGO cartridge (106) /E/	£44.95	3 1/2" library box10 (124)	£ 2.95
PASCAL cartridge(107) /E/	£44.95	16K EPROMS (131)	£ 3.75
VIEW pack BBC (118) /B/	£49.00	VIEWSTORE (117) /M/B/(e)	£57.95
AP4 100 (140) /E+1/	£198.97	AP4 400 (141) /E+1	£228.98

Equipment codes /M/ = Master /B/ = BBC /E/ = Electron /E+1/ = Electron + Plus 1

Please send order to:-
Advanced Computer Products Ltd.
6 Ava House, High Street,
CHOBHAM, Surrey, England
GU24 8LZ. Tel. 0276 76545
(mail order only)



(in event of any query -
please include your tel. no.)

NAME	PROD NO	PRODUCT	QTY	@	TOTAL
ADDRESS					
POSTCODE					
TEL.					
CREDIT CARD No.					
				I enclose payment for £.....	
				Exp date	(A16)

NEWS

News in brief

● Slogger's Master Ramboard gives the Electron as much memory as a second processor. It acts as shadow RAM, giving up to 28k for Basic and applications, or as a 28k printer buffer.

The kit costs £54.95, or you can send your Electron to Slogger and it will fit the board for £64.95. Slogger is on (0634) 52303.

● Watford has launched the Printer Driver ROM for View users at £32 + VAT. It includes facilities to define pad characters, printer pauses to change daisy wheels, fonts and text colour.

● Acorn's network database, *Supastore*, can be accessed by several users at a time over Econet.

The menu driven program is held in an 8k ROM. Data is held in record format, and the records can be searched using up to 10 criteria.

● The first two software pirates have been prosecuted under the Copyright Act. In separate cases, two men were fined £200. Several other cases are pending.

● Qudos has released two packages for people who want to design their own chips.

Quickchip is a complete hardware and software system, based on the 32-bit Acorn Cambridge Workstation. It includes a 20M hard disc, networking and communications interfaces, and CAD

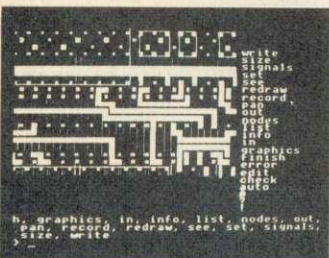

Design a chip with *Quickchip*

software for £7500. Designs can be sent on disc to Qudos who can return the chips in weeks.

A lower level version of the software is available for the BBC micro at £500.

Details on (0223) 862333.

Master to drive video disc



Acorn has produced a special interactive video version of the Master ready for Domesday.

The BBC's Domesday Project is nearing completion and the company has revealed details of how the end product will look, including a specially modified Master to control the video disc player.

The Domesday Project is the most in-depth survey of the United Kingdom ever undertaken. Led by the BBC, it involves Acorn, Philips, Logica, the Department of Trade and Industry and about 14,000 schools.

The product of all this activity will be a database of over 50,000 pictures and 150,000 pages of text contained on two double-sided video discs. There are maps of all parts of the UK. Text and pictures

can be found using keyword searches. You can take simulated walks around parts of the country and graphs and charts can be created from some of the data.

The discs are played on a Philips LaserVision player controlled by the new Master AIV computer. For the record, it's essentially a Master Turbo fitted with a small computer system interface - a bi-parallel interface, capable of handling large amounts of data.

The new Master also has a Videodisc Filing System (VFS) ROM to handle the blocks of text, still and moving pictures.

Acorn expects that most people will buy the complete system - player, micro, RGB monitor and tracker ball - as a factory-assembled package. However, existing

Turbo owners can upgrade.

The whole system is based on the LaserVision LV-ROM standard (similar to CD-ROM), so the system may attract large businesses and teacher training establishments who can use it to run existing training packages.

The system is planned to appear shortly before Christmas, although the price hasn't yet been fixed. Promotion is already under way, however, with the BBC sending a videotape simulating the Domesday database to key people in education and business. Acorn's Chris Turner said that 'the reaction to the video has been very encouraging.'

More details from Broadcasting Support Services (Domesday), PO Box 7, London W3 6XJ.

New battery pack for the Master

Acorn has cleared up the confusion surrounding the battery replacements on the Master.

Replacements for the original lithium battery, which could overheat as a result of reverse charging, are already being sent out. But some people are concerned that the new battery pack takes up the space, between the power supply and main board, originally reserved for an internal modem or video disc interface. Masters being manufactured now will have this fitted as standard.

The replacement kit consists of three Duracel batteries taped to a metal support plus a new battery

nest. But future replacements, and future Masters, will have a completely new plastic mounting, similar to the original but capable of taking three cells rather than one.

Anyone who has an internal modem or video disc interface installed will also have the new battery mount fitted.

Around 22,000 Masters have been sent out with lithium batteries. Acorn has notified all its dealers, local education authorities, regional health authorities and service centres about the replacements and will be taking advertisements in magazines.

Ring Acorn on (0223) 214411.

FREE SOFTWARE!

That's what we're offering to readers this month to celebrate our 50th issue. The first 100 readers (10 reserved for overseas entries) who send in the coupon below will receive a free copy of this month's listing disc or cassette (state which).

So fill it in, clip it out and send the coupon to: 50th Birthday Offer, Acorn User, 141-143 Drury Lane, London WC2B 5TF.

If I'm one of the first 100, send me a disc/cassette (please delete) of the September listings.

Name

Address

.....

.....

.....

Computers by Post

LOWEST U.K. PRICES GUARANTEED



PRINTER RIBBONS



		2+	5+	12+
ACORN	AP80	£2.95	£2.40	£2.30
	AP100	£2.95	£2.40	£2.30
AMSTRAD	DMP1	£3.90	£3.30	£3.10
	DMP2000	£4.60	£4.30	£4.20
	PCW8256/8512	£4.60	£4.30	£4.20
BROTHER	HR5	£3.00	£2.80	£2.60
	HR15 Corr	£2.90	£2.50	£2.30
	HR15 FAB	£3.60	£3.10	£2.90
	HR15 MS	£3.50	£3.00	£2.80
	HR15 also for HR25/HR35			
	EP44	£2.90	£2.50	£2.30
	M1009	£3.70	£3.20	£3.00
CANON	PW1080A Black	£3.40	£2.90	£2.70
	PW1080A Red or Blue	£5.30	£4.70	£4.40
	PJ1080 Ink Jet Colour. One Off			£10.90
	PJ1080 Ink Jet Black. One Off			£8.90
CBM	1515	£2.95	£2.40	£2.30
	1525	£2.95	£2.40	£2.30
	MPS801	£3.90	£3.30	£3.10
	802/1526	£4.00	£3.20	£3.00
	803	£3.70	£3.20	£3.00
	MPS1000	£3.00	£2.60	£2.40
	4022	£3.00	£2.60	£2.40
	MSC801 Colour. One Off			£18.50
	DPS1101 SS	£1.60	£1.30	£1.20
	DPS1101 MS	£2.50	£2.10	£2.00
	DPS1101 Corr	£1.80	£1.50	£1.40
CENTRONICS	GLP	£3.70	£3.20	£3.00
CITIZEN	120D	£5.00	£4.60	£4.30
DAISYSTEP	2000 MS	£3.10	£2.60	£2.40
	2000 FAB	£4.90	£4.20	£4.00
EPSON	MX/FX/RX80 Black	£3.00	£2.60	£2.40
	MX/FX/RX80 Red or Blue	£4.20	£3.50	£3.30
	100 Series	£5.00	£4.60	£4.30
	LX80	£3.00	£2.60	£2.40
	JX80 Colour. One Off			£18.50
	LQ800	£3.90	£3.50	£3.30
	LQ1500	£4.50	£3.90	£3.60
JUKI	6000/2200 FAB	£3.70	£3.40	£3.20
	6000/2200 Corr	£4.00	£3.60	£3.40
	6000/2200 SS	£3.10	£2.70	£2.50
	6100 MS	£2.50	£2.10	£2.00
	6100 SS	£1.60	£1.30	£1.20
	6100 Corr	£1.80	£1.50	£1.40
KAGA	KP810 Black	£3.40	£2.90	£2.70
	KP810 Red or Blue	£5.30	£4.70	£4.40
M/TALLY	MT80	£4.00	£3.20	£3.00
OKI	80/82	£1.60	£1.30	£1.20
	84	£3.90	£3.40	£3.20
	Mate 20 Colour	£3.00	£2.60	£2.40
	Mate 20 Black	£6.60	£6.20	£6.00
PANASONIC	KX1091/2	£5.00	£4.60	£4.30
QUENDATA	DWP1120 MS	£3.10	£2.60	£2.40
	DWP1120 FAB	£4.90	£4.20	£4.00

QUME	Sprint 7/9 MS	£3.10	£2.60	£2.40
	Sprint 7/9 FAB	£4.90	£4.20	£4.00
SEIKOSHA	GP50	£6.00	£5.50	£5.20
	GP80	£2.95	£2.40	£2.30
	GP100/250	£2.95	£2.40	£2.30
	GP500/550	£3.90	£3.30	£3.10
	GP700 Colour. One Off			£18.50
	SP1000	£6.00	£5.50	£5.20
SHINWA	CP80	£4.00	£3.20	£3.00
SMITH	TPI M/S	£8.50	£7.90	£7.20
CORONA	TPI Fabric	£3.90	£3.60	£3.40
	TPI Corr	£5.00	£4.70	£4.50
	Fastex 80X	£6.00	£5.50	£5.30
	D100/200	£9.00	£8.50	£8.20
STAR	D300	£6.00	£5.50	£5.30
	DP/GEM/SG	£1.60	£1.30	£1.20
	SR15	£4.90	£4.50	£4.30
	NL10	£5.60	£4.90	£4.60

FLOPPY DISKS

Model	Capacity	BOXES OF 10 DISKS		
		1-2	3-9	10+
JVC inc Plastic Case				
MD-1D	S/size D/dens 40TR	£9.99	£9.50	£9.25
MD-2D	D/size D/dens 40TR	£11.99	£11.50	£11.25
MD-2DD	D/size Q/dens 80TR	£15.99	£15.50	£15.25
MD-2HD	D/size H/dens 1.6MB	£26.99	£25.99	£25.49
BASF				
1D	S/size D/dens 40TR	£10.99	£10.50	£10.25
2D	D/size D/dens 40TR	£12.99	£12.50	£12.25
1D/96	S/size Q/dens 80TR	£13.49	£12.99	£12.49
2D/96	D/size Q/dens 80TR	£16.49	£15.99	£15.49
2HD	D/size H/dens 1.6MB	£28.49	£27.49	£26.49
VERBATIM - DATA LIFE				
MD525	S/size D/dens 40TR	£11.99	£11.75	£11.49
MD550	D/size D/dens 40TR	£14.99	£14.75	£14.49
MD577	S/size Q/dens 80TR	£14.99	£14.75	£14.49
MD557	D/size Q/dens 80TR	£19.99	£18.99	£18.50
MD HD	D/size H/dens 1.6MB	£27.99	£26.99	£25.99
SONY				
S/size D/dens 40TR		£12.49	£11.99	£11.75
D/size D/dens 40TR		£15.49	£14.99	£14.75
D/size Q/dens 80TR		£20.49	£19.99	£19.75
3 1/2"				
JVC	S/size D/dens	£18.99	£18.25	£17.99
SONY	S/size D/dens	£19.99	£19.25	£18.99
SONY	D/size D/dens	£31.50	£30.50	£28.99
BULK 3 1/2" D/SIDE D/DENS DISKS BY VERBATIM				
5 x Disks		£3.13 each		£15.65 pack
10 x Disks		£2.50 each		£25.00 pack
20 x Disks		£2.08 each		£41.60 pack
3" DISKS				
CF2 5 Disks		£3.49 each		£17.45 pack
CF2 10 Disks inc plastic library case		£3.05 each		£30.50 pack
CF2DD 5 Disks		£6.10 each		£30.50 pack
CF2DD 10 Disks inc plastic library case		£5.25 each		£52.50 pack

DISK STORAGE



MODEL	SIZE	CAPACITY	PRICE
DD40L	3"/3.5"	40	£8.90
MD60T	3"/3.5"	60	£12.50
DD50	5 1/4"	50	£8.90
DD70	5 1/4"	70	£10.90
DX85	5 1/4"	90	£12.90
DD100	5 1/4"	100	£13.90
LIBRARY CASE	5 1/4"	10	£1.50
NON-LOCKABLE DISK BOXES			
MD12/30	3"/3.5"	24	£7.20
MF50	5 1/4"	50	£8.00
MICRODRIVE HOLDERS			
WALLET		4	£1.75
WALLET		20	£4.50

PRINTER CABLES & INTERFACES



AMSTRAD	Parallel	£8.90
ATARI ST	Parallel	£14.50
BBC	Parallel	£6.50
IBM	Parallel	£14.50
MSX	Parallel	£10.90
CBM 64/128	Parallel I/F	£59.90
SINCLAIR QL/SPEC 128	Parallel I/F	£26.50
SINCLAIR SPECTRUM	Parallel I/F	£32.50
AMSTRAD PCW	Parallel/Serial I/F	£49.90

COMPUTER STATIONERY

SIZE	GSM	QUANTITY	PRICE	
			1 BOX	2 BOXES
11 x 9 1/2	60	2000	£12.90	£12.00
11 x 9 1/2	80	2000	£15.90	£14.50
EXACT A4	70	2000	£21.50	£18.75
11 1/2 x 9 1/2	90	1000	£13.50	£11.25

COMPUTER LABELS

SIZE	PRICE PER THOUSAND	
	1000	2000+
70 x 36mm	£4.40	£4.00
89 x 36mm	£4.50	£4.10
89 x 49mm	£6.20	£5.70
102 x 36mm	£4.70	£4.40

Please state number of labels across sheets (1, 2 or 3).

ENVELOPES

SIZE	PRICE PER BOXED BOX	
	500	1000
110mm x 220mm White Self Seal 90gsm	£11.50	£17.90
110mm x 220mm Manilla Banker Gummed 70gsm	£5.00	£9.50
324mm x 229mm Manilla Self Seal 90gsm	250	£17.90

PRINTERS		COMPUTERS	
Epson LX80	£189.95	Acorn BBC Master	£419.95
Epson LX86	£209.95	Amstrad PCW8256	£489.95
Epson FX85	£334.95	Amstrad CPC464 Green	£169.95
Epson FX105	£435.95	Amstrad CPC464 Colour	£254.95
Epson EX800	£384.95	Amstrad CPC6128	£254.95
Epson LQ800	£454.95	Amstrad CPC6128 Colour	£339.95
Epson LQ1000	£607.95	Atari 520ST ROM	£269.95
Epson JX80 colour	£369.95	Atari 520STM	£279.95
Citizen 120D	£155.95	Atari 1040STF + mono mon.	£685.95
Amstrad DMP2000	£139.95	Atari 1040STF + col. mon.	£799.95
Brother 1509	£416.95	Commodore C64	£139.95
Oki-mate 20 Colour	£169.95	Commodore C64C	P.O.A.
Micro P MP165	£199.95	Commodore C128 + cass.	£209.95
Seikosha SP1000A	£199.95		
Seikosha MP1300A	£349.95		
Star NL10 inc I/F	£209.95		
Star SG15	£299.95		
Star SD10	£299.95		

SOFTWARE		MONITORS	
View	£33.95	Philips CM8501	£205.95
View 3.0	£51.95	Philips CM8524	£229.95
View Store	£33.95	Philips CM8533	£265.95
View Sheet	£33.95	Philips BM7502 Green	£79.95
View Print driver	£7.95	Philips BM7522 Amber	£85.95
Wordwise plus	£39.95	Philips BM7542 White	£89.95
Intersheet	£39.95	Philips BM7513 IBM	£105.95
Interword	£26.95		
Interchart	£23.95		
Print master	£23.95		
Caretaker	£23.95		
Graphics ROM	£43.95		
Communicator	£12.95		
Mini Office II Cass.	£12.95		
Mini Office II Disk 40TR	£14.50		

Datagem	£59.95
Home accounts cassette	£16.95
Home accounts disk	£19.95
DDD Base	£24.95
DDD Calc.	£24.95
DDD Plot	£24.95
Combo DDD	£55.95
Office Mate Disk	£10.95
Office Master Disk	£20.95
AMX Mouse + Superart	£65.95
AMX Pagemaker	£41.95
AMX Desk	£19.95
AMX Super art	£41.95
AMX Database	£19.95
Fleet Street Editor 40TR	£34.95
Fleet Street Editor 80TR	£34.95

DELIVERY Hardware £5 + VAT 4 Day Delivery
ALL CONSUMABLES AND SOFTWARE POST FREE £9 + VAT 24 Hour Delivery

GALASET GUARANTEE If after buying any of the hardware or software in this advertisement, you find the same item offered at a lower price locally within one week, Galaset will refund the difference.

All prices exclude VAT
CREDIT CARD HOT-LINE

01-760 0014

Galaset Ltd, 30 Bayford Road, Littlehampton, West Sussex.

Export Enquiries Welcome

To: **Galaset Ltd, 30 Bayford Road, Littlehampton, West Sussex.**
 I wish to order _____

I enclose cheque/PO for £ _____ inc VAT
 or charge my Access/Visa No: _____

Name _____
 Signature _____
 Address _____
 Postcode _____ Tel No: _____

Faster, cheaper Prestel service

Prestel has announced major changes to the system, speeding up the service by allowing keyword searches and faster access rates, and dropping time charges for educational users.

Most of the technical changes should be with us in the next year, but some will not be as advanced as most people had hoped.

Keyword searching will only work on indexes – the main menus at the head of a specific section of



pages. Entering *NEWS, for example, would take you to the main news menu. But you won't be able to search the text itself for specific words. The software for this is currently being tested on the Kipling computer.

This improvement should make Prestel and sub-sections like Miconet faster to use, by cutting out a number of intermediate pages and making directories of page numbers unnecessary. But it is not the kind of database service that many people hoped for.

On the messaging side, users will be offered features such as acknowledgement of receipt and the facility to forward incoming messages to third parties, having attached their own comments.

As with Telecom Gold, you will be able to scan awaiting messages without reading them in full, and reply to ones you have read with the system filling in the recipient's mailbox number for you. Other improvements include longer messages and mailing lists. The bad news is that most of the changes will take around a year, and some of them won't be with us for two years or so.

People who start to use the system more might appreciate the new high speed data modes. By the middle of next year most of the country should be able to access Prestel at 1200 and probably 2400 baud both ways.

On the educational front, Prestel is offering a new tariff. Schools may pay £192 per year, rather than £80, but with no time charges. At 4p a minute with the existing system, any school which accesses Prestel for more than 47 hours per year will benefit.

Check on data users

We may soon see the first court case as a result of the Data Protection Act. The registrar is now examining ways of enforcing the act, a task not dissimilar to finding TV licence dodgers.

Complaints are generating a lot of the investigation work, but the registrar is not relying on them. His staff will be actively pursuing data abusers.

Once the information about registered data users has been put on to computer files, the Registrar's Office will compare the list

of registered users against what the registrar calls 'published lists of potential data users'. These will include trade and other similar directories.

The full force of the law for prosecuting people who misuse data will not be available until November 1987.

But people can already be prosecuted for non-registration. John Lamidey, in charge of investigations, told *Acorn User*: 'There will be a prosecution as soon as we can prove it.'

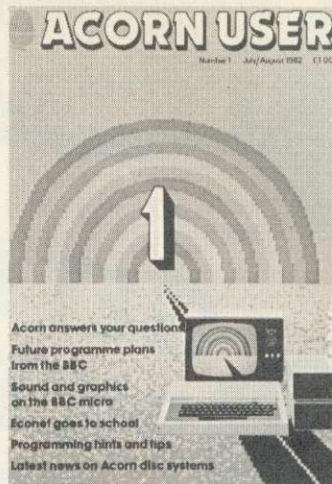

From humble beginnings . . .

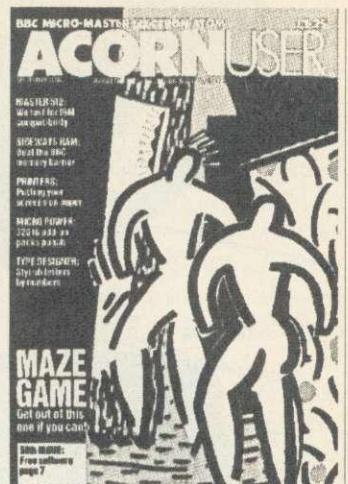

. . . to the bumper issues of today

An interesting year to be 50

ACORN USER celebrates its 50th issue this month. Four years have seen a lot of changes and 1986 will see more than any other since the launch of the BBC micro. Already we've seen the Master, the first worthwhile change since 1981, and there's more to come.

Acorn appears to be almost out of the financial quagmire, although the pruning can be seen in the lack of back-up on the Master and the profiteering on manuals. Problems with the Master have led to fears that show the company still retains the marketing and PR skills of a brick.

The RISC factor

However, faith in the company is strong. The Master is a good computer and there's RISC power on the horizon.

Will Acorn come out of the education closet and tackle the home market?

If Acorn is going to 'do an Amstrad', it had better be done well. Can the company put together advertising as good as Alan Sugar's. The promised campaign for the Master has yet to be seen (or did we all miss it?).

And what effect will the 'internationalisation' of Acorn by Olivetti have?

More questions than answers,

I'm afraid. At present I'm going through all the reader survey forms you've sent us. Editing a magazine like this takes you away from the grass-roots readership, but there's nothing like a hundred survey forms to chop your legs off at the knees and bring you down to earth. You'll be seeing the results before the end of the year.

Write on

For the rest of the time I have to rely on feedback. Keep the letters coming – and send some to Acorn as well. The big boss Brian Long is undoubtedly short of user comment that hasn't been filtered and turned into those damned lies called statistics.

Finally, a plea to the silent majority – women. Things have changed little since my first editorial on the subject more than two years ago. Computing is dominated by men for men. A friend told me earlier she'd rather spend £500 on riding every weekend for a year than on a micro. I can't argue with that.

Still, bigger chips will mean computers can start to do things properly, and Acorn has a good one. It's called RISC. Tell Acorn how to use it.

Tony Quinn
Editor

GET IN THE PICTURE WITH BEEBUG

JOIN BRITAIN'S LARGEST COMPUTER USER GROUP TO GET THE MOST FROM YOUR BBC MICRO & MASTER

• JOIN BY SENDING £12.90 FOR 1 YEAR MEMBERSHIP (10 MAGAZINES)

OR £6.90 for 6 MONTHS MEMBERSHIP (5 MAGAZINES).

OR SEND £1.00 FOR A SAMPLE ISSUE (UK ONLY)

• UK ONLY — OVERSEAS PRICES ON APPLICATION

• MAKE CHEQUES PAYABLE TO BEEBUG
DEPT AC1
PO BOX 109 HIGH WYCOMBE
BUCKS HP10 8NP

- NEWS
- GAMES
- REVIEWS
- UTILITIES
- GRAPHICS
- SOFTWARE
- DISCOUNTS
- PROGRAMS
- HINTS & TIPS
- USER GROUPS
- INFORMATION
- APPLICATIONS
- SPECIAL OFFERS
- TEN MAGAZINES PER YEAR
- TECHNICAL SUPPORT

BBC GIANT TEXT

Item	Price	Notes
BASIC	510.76	
GRAPHICS	817.35	
EXPAN	934.89	
TOOLKIT	1084.88	
EPROM FORM	1263.82	
WORDWISE	1488.76	
GRAPHICS EXTENSION	1718.78	
EPROM FORM	1936.04	
GRAPHICS EXTENSION	2194.39	
GRAPHICS EXTENSION	2432.52	
GRAPHICS EXTENSION	2678.46	
GRAPHICS EXTENSION	2988.48	

SIDEWAYS ROM INDEX

ROM NUMBER	ROM TITLE
13	BASIC
14	BCPL
15	EXPAN
16	TOOLKIT
17	EProm Form
18	WORDWISE
19	GRAPHICS EXTENSION

Name	Description
1. B. TRACKER	PROGRAM TRACKER
2. B. P2	calculator file input demo
3. B. P3	calculator file input demo
4. B. P4	calculator file input demo
5. B. P5	calculator file input demo
6. B. P6	calculator file input demo
7. B. P7	calculator file input demo
8. B. P8	calculator file input demo
9. B. P9	calculator file input demo
10. B. P10	calculator file input demo
11. B. P11	calculator file input demo
12. B. P12	calculator file input demo
13. B. P13	calculator file input demo
14. B. P14	calculator file input demo
15. B. P15	calculator file input demo
16. B. P16	calculator file input demo
17. B. P17	calculator file input demo
18. B. P18	calculator file input demo
19. B. P19	calculator file input demo
20. B. P20	calculator file input demo
21. B. P21	calculator file input demo
22. B. P22	calculator file input demo
23. B. P23	calculator file input demo
24. B. P24	calculator file input demo
25. B. P25	calculator file input demo
26. B. P26	calculator file input demo
27. B. P27	calculator file input demo
28. B. P28	calculator file input demo
29. B. P29	calculator file input demo
30. B. P30	calculator file input demo
31. B. P31	calculator file input demo
32. B. P32	calculator file input demo
33. B. P33	calculator file input demo
34. B. P34	calculator file input demo
35. B. P35	calculator file input demo
36. B. P36	calculator file input demo
37. B. P37	calculator file input demo
38. B. P38	calculator file input demo
39. B. P39	calculator file input demo
40. B. P40	calculator file input demo
41. B. P41	calculator file input demo
42. B. P42	calculator file input demo
43. B. P43	calculator file input demo
44. B. P44	calculator file input demo
45. B. P45	calculator file input demo
46. B. P46	calculator file input demo
47. B. P47	calculator file input demo
48. B. P48	calculator file input demo
49. B. P49	calculator file input demo
50. B. P50	calculator file input demo
51. B. P51	calculator file input demo
52. B. P52	calculator file input demo
53. B. P53	calculator file input demo
54. B. P54	calculator file input demo
55. B. P55	calculator file input demo
56. B. P56	calculator file input demo
57. B. P57	calculator file input demo
58. B. P58	calculator file input demo
59. B. P59	calculator file input demo
60. B. P60	calculator file input demo
61. B. P61	calculator file input demo
62. B. P62	calculator file input demo
63. B. P63	calculator file input demo
64. B. P64	calculator file input demo
65. B. P65	calculator file input demo
66. B. P66	calculator file input demo
67. B. P67	calculator file input demo
68. B. P68	calculator file input demo
69. B. P69	calculator file input demo
70. B. P70	calculator file input demo
71. B. P71	calculator file input demo
72. B. P72	calculator file input demo
73. B. P73	calculator file input demo
74. B. P74	calculator file input demo
75. B. P75	calculator file input demo
76. B. P76	calculator file input demo
77. B. P77	calculator file input demo
78. B. P78	calculator file input demo
79. B. P79	calculator file input demo
80. B. P80	calculator file input demo
81. B. P81	calculator file input demo
82. B. P82	calculator file input demo
83. B. P83	calculator file input demo
84. B. P84	calculator file input demo
85. B. P85	calculator file input demo
86. B. P86	calculator file input demo
87. B. P87	calculator file input demo
88. B. P88	calculator file input demo
89. B. P89	calculator file input demo
90. B. P90	calculator file input demo
91. B. P91	calculator file input demo
92. B. P92	calculator file input demo
93. B. P93	calculator file input demo
94. B. P94	calculator file input demo
95. B. P95	calculator file input demo
96. B. P96	calculator file input demo
97. B. P97	calculator file input demo
98. B. P98	calculator file input demo
99. B. P99	calculator file input demo
100. B. P100	calculator file input demo

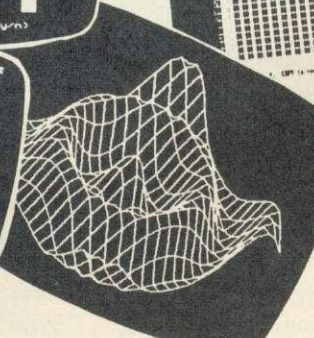
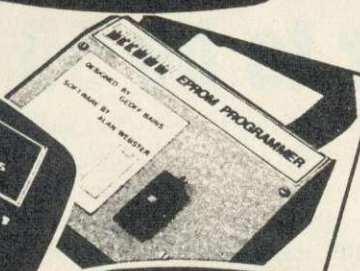
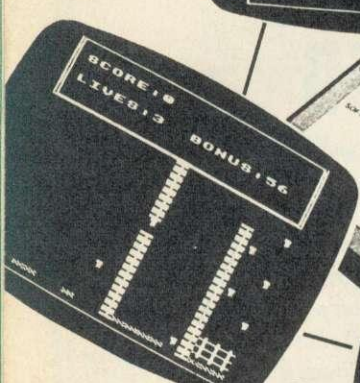
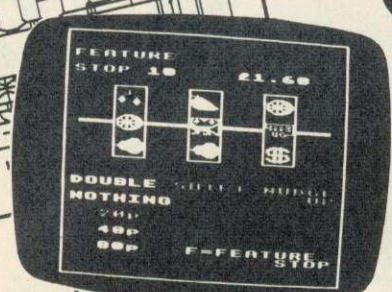
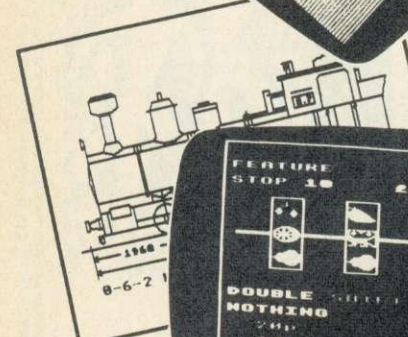
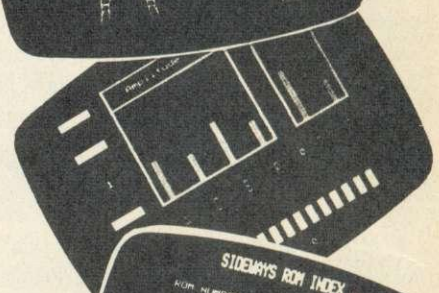
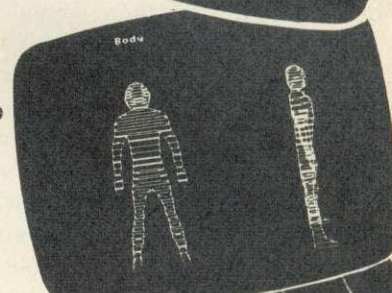
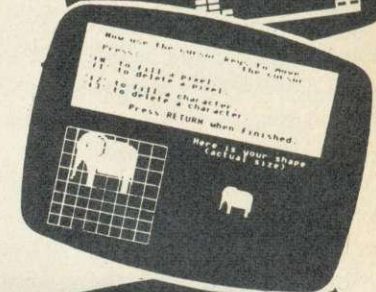
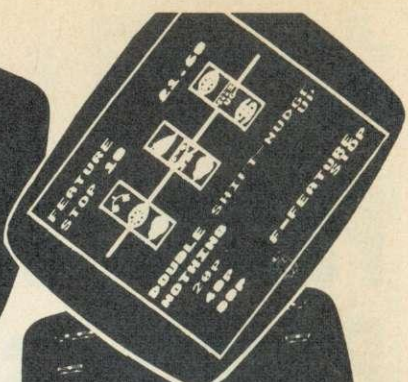
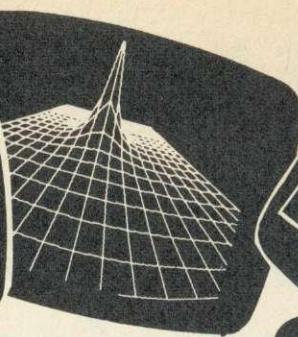
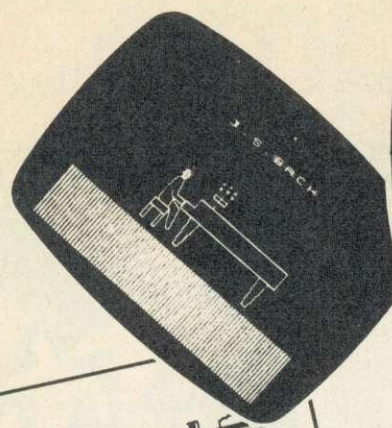
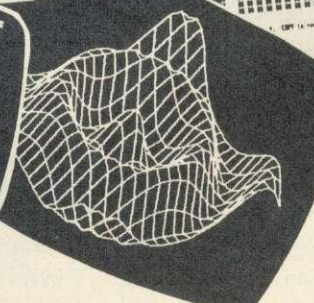
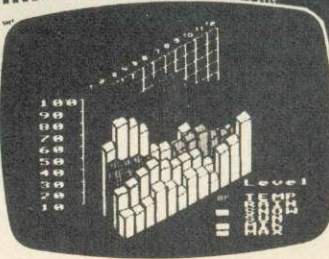

Carve your CAD designs

A new CAD package from Technomatic lets you carve your designs in wood, glass and plastic.

The basic graphics workstation system consists of a three-colour plotter, software and attachments. There is an opto-sensor which can scan a picture to produce a digitised image, which can then be enhanced and modified by the software. This is particularly useful for correcting any glitches in the scanned picture, where bits have dropped out or the sensor has had trouble reading details.

Most interesting is the drill rotor attachment. This can take a variety of bits, including a diamond tool to engrave glass. Other

bits are used for wood and plastic. Most types of wood can be used, but some plastics have problems with the heat generated by the drill bit.

The outfit interfaces with Technomatic's *Novacad* design software. This effectively allows three-dimensional modelling. You can produce two-dimensional designs on up to eight discrete levels. When it comes to transferring the design to wood or plastic each level is plotted individually. By changing the height of the drill bit after each plotting operation, you can produce three-dimensional carvings.

Possible applications for this,

apart from producing works of art, are building models of street plans and creating moulds.

You can also attach other devices. The people at Technomatic have used an airbrush with the plotter to produce repeatable colour paintings.

The cost of the package starts at around £630 with an A3 plotter. Systems can be put together to your own specifications with plotters up to just over A0 in size. The *Novacad* software is sold separately for around £80.

Details and prices are available from Technomatic, 17 Burnley Road, London NW10 1ED. Tel: 01-208 1177.

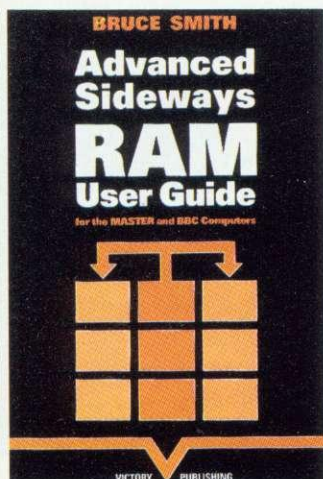

Bruce's book

The secrets of sideways RAM are laid bare in a new book by AU Technical Editor Bruce Smith.

Advanced Sideways RAM User Guide for the Master and BBC Computers covers Acorn's ROM filing system, compatibility tables, a formatter to convert Basic programs to work as ROM software, details of all the SRAM utilities in the Master and full details of how it all works.

All service calls are covered, including the extra ones provided on the Master. There are also 25 programs and routines which illustrate the techniques.

The book costs £9.95. Discs containing the programs in the book are available in Master and BBC versions at £7.95 each, or you can buy the book and disc together for £14.95. All prices include postage. Order from Victory Publishing, PO Box 19, London N11 1DS.

Too many ads

Acorn User has had to reorganise the system for free ads because far more are received each month than we can possibly publish.

If you sent in a free ad which was received before Monday 14 July and it is not in this issue then it is unlikely to be published. From now on, this method will be used and any extra ads which do not make an issue will be disposed of. We hope this will lead to a more efficient service.

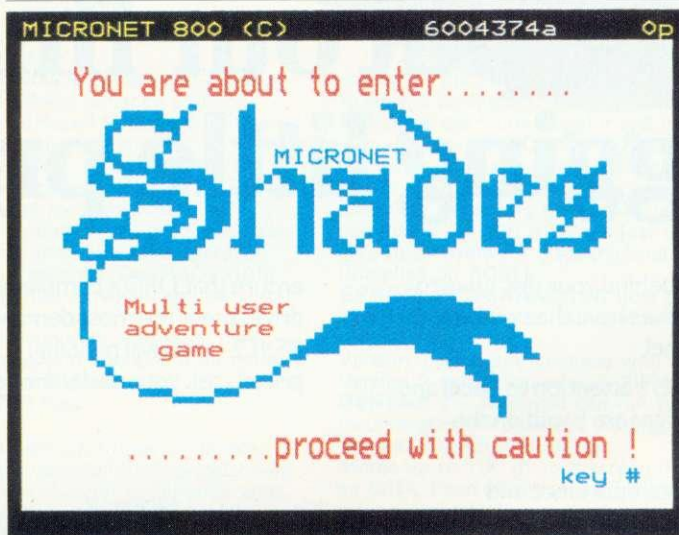

Free modems from Micronet

Micronet is giving away modems. Following the lead of the French Teletel system, which gave free viewdata sets to customers, anyone taking out a full year's subscription to Prestel and Micronet will receive a Prism 2000 modem and viewdata ROM.

It now means that getting on to Micronet and Prestel will cost you just under £50 for hardware, software and membership.

Micronet is also giving away money by launching a £1000 software competition. The prize is for a program that increases awareness among able-bodied people of

the problems that society creates for the handicapped.

The closing date is 30 November, and more details are available from Micronet or from David Wrinch, PHAB, Tavistock House North, Tavistock Square, London WC1H 9HL.

Finally, the multi-user Micronet game *Shades* (above) is now planned for an early September launch. It is currently being tested by a few avid games players whose job is to uncover the bugs. There will be no subscription charge for the game but there is a time charge of 99p an hour.

Health fears in the House

Controversy continues to bubble in the Commons over whether classroom computer monitors are a potential health hazard to pupils. One backbencher who is worried about the long-term effects of VDUs is Gerry Bermingham, Labour Member for St Helen's South. He wanted to know just what research had been carried out by the Government into the effects of VDUs on children.

The Health Minister Ray Whitney, replied that no research was being carried out at present, and added: 'None is planned as I am advised it is not warranted.'

Nor, he said, had the Government received any representations about the health effects of monitors on children. 'There is no indication that children in general are at risk from using visual display units,' insisted Mr Whitney.

Mr Bermingham was surprised at the Minister's dismissive response. In particular he was put out by the Whitehall attitude in the light of widespread concern voiced over the effect of VDU screen radiation on pregnant women. The Minister's reply, he complained, was 'short-sighted'.



MD400B

We've put our finger on a nagging little problem.

Instead of having to fumble behind your disc drive to change from 40 to 80 tracks, UFD drives have the switch conveniently located on the front panel.

A feature which reflects UFD's attention to detail and the care taken to ensure that the designs are based on the consumers needs.

Quality, too, is of paramount importance and UFD are proud of their high standard of design and quality control.

All of this may lead you to expect a premium price - not so. In spite of the care taken to

ensure that UFD's complete range of single and twin disc drives meet the most demanding standards (manufactured to BS 415 - approval pending); UFD drives are competitively priced - ask your dealer for details.



AKHTER COMPUTER GROUP
AKHTER HOUSE,
PERRY ROAD, HARLOW,
ESSEX CM18 7PN
TEL (0279) 443521
TELEX: 818894 AKHTER G
Dealer Enquiries
Welcome

**Gold Standard
2 Year Warranty
on all Products**



MORLEY ELECTRONICS

The Morley Teletext adapter introduces you to the world of Teletext at a price that won't break the bank. Inside it you will find the latest in second generation Teletext chip technology, which unlike our rivals who are still using chips designed more than eight years ago, will be fully compatible with any future advances in the Teletext system.

With the Morley adapter you will get a unit that automatically tunes itself in to the required station (no more messing around with screwdrivers in the back of the case), a user friendly menu driven program, easy to follow instructions and a 12 month warranty. Add to this the free downloadable telesoftware and we are sure that you will agree that we are offering you one of the best bargains on the market today.

For technical details please ring Morley Electronics on Tyneside (091) 262 7507

FEATURES

● Advanced design uses the latest technology will handle ANY future enhancements to the Teletext system eg: full field: 8 bit data transfer: 2k pages etc.

- Simply plugs into the Plus 1 interface.
- Low power consumption, less than 200ma. Optional power supply available.
- User friendly menu driven software including extended OSCLI and Oword commands for access from BASIC programs.
- No user-RAM required (PAGE remains at default value).
- FREE Telesoftware, no access charges. (at present updated weekly.)
- Save selected pages to disc/tape for later retrieval.
- Full access to all Teletext services and channels eg: CEEFAX, ORACLE, 4-TEL.
- Gives you a real-time clock at your disposal (*TIME).
- Free software upgrades to allow for any enhancements to the teletext service. Eg: extra channels, full field data on cable & satellite systems etc.
- Easy to follow comprehensive user guide.
- No hardware limitations, it can for example receive virtually unlimited numbers of channels.
- Works with Solidisc SWR.

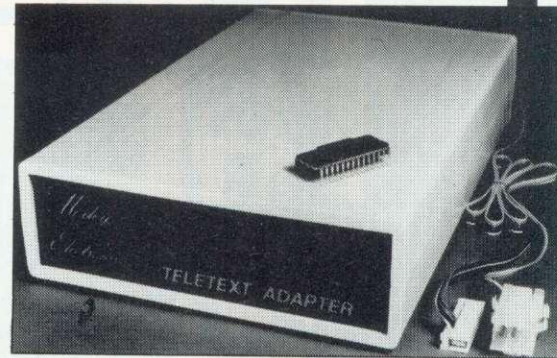

- Utilis disc available including printer drivers allows pages to be selected and dumped direct to a printer (no more TV or Radio Times to buy). **ELECTRON TELETEXT ADAPTER** Electron adapter now available, including emulated Mode 7 allowing you to run long Adventure type programs. Please ring for details.

Now available the first true MEGA capacity RAMdisc for the BBC or MASTER computers.

This fully compatible unit, currently available in either 1 or 2 megabyte versions comes complete with operating software on ROM, power supply, battery backup and a comprehensive user guide, add to this our usual 12 months no quibble guarantee and we're sure you'll agree Morley have done it again.

FEATURES

1 Megabyte of RAM connected to the 1 MHz bus. Used with the supplied ROM software programs and files may be saved and loaded from the RAMdisc in the same manner as from a floppy disc with a large increase in speed, for example, a 20K mode 0 screen takes about 3-4 seconds to load from disc and about 0.2-0.3 seconds to load from the RAMdisc.

The RAMdisc ROM operates as a utility ROM working with the current filing system rather than as a separate filing system. Therefore ensures compatibility with any DFS.

The RAMdisc can be selected by a * command to take the place of any drive number from 0 to 9. If the RAMdisc replaces a floppy drive as 0 for example, all commands addressed to drive 0 will be intercepted by the RAMdisc. The default drive no. is 4.

'Dangerous' * commands such as *COMPACT, *COPY, *BACKUP etc are intercepted and the BBC's RAM from page 2 to &7FFF is saved to RAMdisc workspace, and may be recovered using a * command. This prevents accidental corruption of any programs/data in RAM you may have been using at the time. The save operation delays the * command by just under 0.4 seconds. The BBC's RAM can also be saved by an interrupt-driven routine which can be enabled by a * command.

The 'filing system wedge' ROM supplied supports load/save, byte file access, all relevant OSFSC commands, and contains a formatter, verifier and 'sector' editor for use with the RAMdisc.

Catalogue structure allows up to 2,709 files.

APPLICATIONS

Programs and ROMs can be written to take advantage of directly accessing a single RAMdisc, allowing the possibility of spreadsheets with more than 512 x 512 cells, million-character documents with immediate access and editing of any section, manipulation of 2 floating-point arrays each with 228 x 228 elements, a fast-access database with 10,000 100-character records, or even just a large printer buffer!

Accessible through the user's software for direct storage of eg: basic procedures, variables, large arrays etc which can be downloaded into the BBC's RAM or read directly. (We are hoping to be able to supply an extended basic ROM late this year, to allow 'transparent access' to the Ramdisc, which will effectively expand the BBC's RAM to about 1020k.)

OPTIONAL SIDWAYS RAM UTILITY (suitable for use with any 16k SWR)

Sidways ROM images can be saved to the RAMdisc under a special directory which, when enabled, will be used when an unrecognised * command is trapped for the ROM to load sideways ROMs from disc into sideways RAM. The * command will then be



passed to the new ROM image and if still unrecognised the next ROM will be loaded. If no ROM loaded from the RAMdisc intercepts the * command it will be passed to the current filing system as usual. ROMs on RAMdisc can be individually disabled in the same manner as 'real' ROMs in the BBC itself. Up to 104 8k ROMs can be saved onto the standard 1Mb RAMdisc, and the total load time (excluding time taken by the ROMs to process the command) for 100 ROMs is just under 9 seconds. All relevant control software for disabling/enabling ROMs etc. is provided. (Supplied on ROM.)

EPROM PROGRAMMER now available programs 8, 16 and 32k EPROMS connects to the user port software available on rom or disc.

Version 1 economy uncased with standard DIL socket.

Version 2 deluxe cased with ZIF socket.

DESFAX 7 - Now you can run your own TELETEXT service!

Incorporates the powerful editing facilities of DESIGN 7, again with Teletext adapter interfacing.

Stores up to 100 of your screen designs on a 40tk disc or 200 on an 80tk. Page selection by 3-digit number HOLD, REVEAL, page linking, individual page delays etc.

PLUS - a powerful CAROUSEL facility permits continuous slide-shows. Only one disc access for every 16 screens - reduces wear on drives. Smooth animation, variable speed text printing, built in printer dumps. Sample data disc and 22 page manual included. Beats all other systems for ease of use and versatility.

M/B software DESIGN 7

Easily the best value Mode 7 screen designer on the market today. Design any mode 7 screen, from simple MENU pages to full CEEFAX standard. This program is an invaluable aid. Designs can be saved to disc as automatically numbered files or the program will convert the screen into a Basic Proc.

INTERFACES DIRECTLY WITH ADAPTER allowing CEEFAX-ORACLE pages to be selected and dropped into editor screen for alteration, saving, or conversion to BASIC. Allows channel change from within program.

To order please fill in and send order form to: **MORLEY ELECTRONICS, Unit 3, Maurice Road Industrial Estate, Wallsend, Tyne and Wear NE28 6BY.**

<p>NOW AT NEW PREMISES</p>	Qty. <input type="checkbox"/> Morley Teletext adapters	@ £74.45 inc. VAT & P&P.	Qty. <input type="checkbox"/> 1 Mbyte RAM disc	@ £199.95 inc. VAT & P&P.
	Qty. <input type="checkbox"/> Teletext software on Rom	@ £24.95 inc. VAT & P&P.	Qty. <input type="checkbox"/> 2 Mbyte RAMdisc	@ £349.95 inc. VAT & P&P.
	Qty. <input type="checkbox"/> Teletext software on Disc	@ £23.95 inc. VAT & P&P.	Qty. <input type="checkbox"/> Utills ROM	@ £18.95 inc. VAT & P&P.
	Qty. <input type="checkbox"/> M/B DESIGN7 screen designer	@ £8.95 inc. VAT & P&P.	Qty. <input type="checkbox"/> Eprom Programmer V.1	@ £18.95 inc. VAT & P&P.
	Qty. <input type="checkbox"/> Teletext utilities on Disc	@ £5.95 inc. VAT & P&P.	Qty. <input type="checkbox"/> Eprom Programmer V.2	@ £27.95 inc. VAT & P&P.
	Qty. <input type="checkbox"/> Optional PSU	@ £9.95 inc. VAT & P&P.	Qty. <input type="checkbox"/> Desfax	@ £24.00 inc. VAT & P&P.

NB. ROM or Sideways RAM software must be purchased with Teletext Adapters.

Total £



NAME _____ PHONE No. _____ CHEQUE No. _____

ADDRESS _____

POSTCODE _____

Please allow 28 days for delivery.

TOGETHER FOR THE FIRST TIME

20 MB WINCHESTER 10 MB TAPE STREAMER 1 MB FLOPPY DRIVE

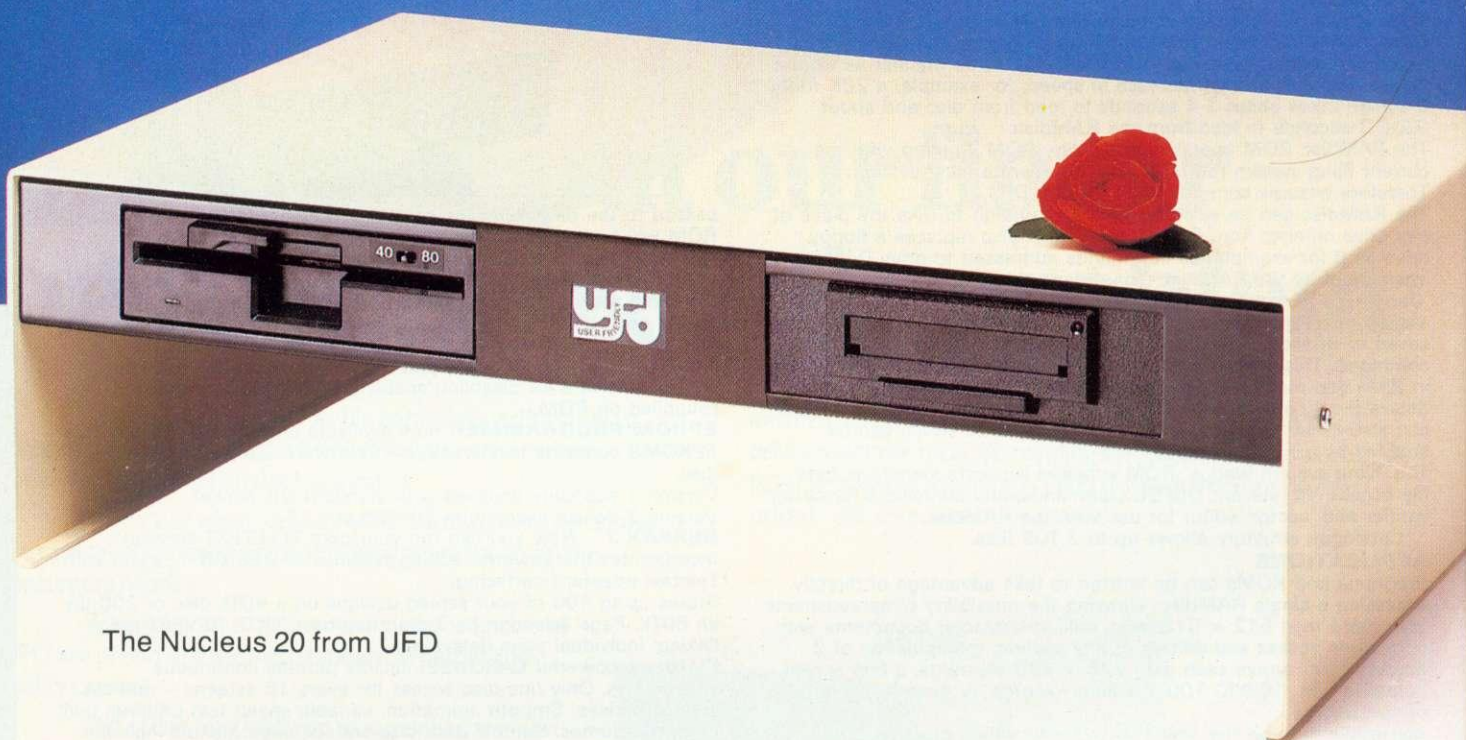

The Nucleus 20 from UFD

Well they say two's company and three's a crowd, but not with the new Nucleus 20 from UFD.

The Nucleus 20 is the only BBC compatible mass storage unit featuring an in-built 20 MB Winchester, a 10 MB Tape Streamer for back-up security, and an 1 MB 5¼ DS Disk Drive with 40/80 track using ADFS to offload data onto hard disk.

All neatly packaged in one unit, your BBC sits underneath, with your monitor on top. The unit has its own power supply so you can plug it straight into the mains, and comes complete with all necessary connections.

All these features cost a lot less than you think, and they're backed by a 2 year Gold Standard Warranty. Ask your dealer for details, or telephone Akhter on (0279) 443521.



AKHTER COMPUTER GROUP
AKHTER HOUSE,
PERRY ROAD, HARLOW,
ESSEX CM18 7PN
TEL: (0279) 443521
TELEX: 818894 AKHTER G

Dealer Enquiries
Welcome



An Akhter
Group Company

Colourful card

Another colour card for the BBC micro has arrived, this time from Focus Electronics. It uses the standard BBC colours but allows you to define the colour palette for each line of the display.

In a two colour mode, for example, each scan line can have only two colours, but these can be different from the previous line, and the next can be different again. So you have access to all the Beeb's colours in mode 0.

Programming the card is easy as it uses an extension of the VDU23 command. And the operating software has been written legally so it should work with other software, such as the Graphics Extension ROM. Its presence is practically transparent to the machine, and output is through the normal video ports.

The card is installed by removing the video ULA chip, plugging the card into the empty socket and plugging the ULA into the card. The product is intended for BBC B owners - Focus cannot guarantee that it will work on a Master.

The price is £65 plus postage, and details are available from Focus Electronics, 26 Hamwick Green, Lordswood, Chatham, Kent ME5 8TW.

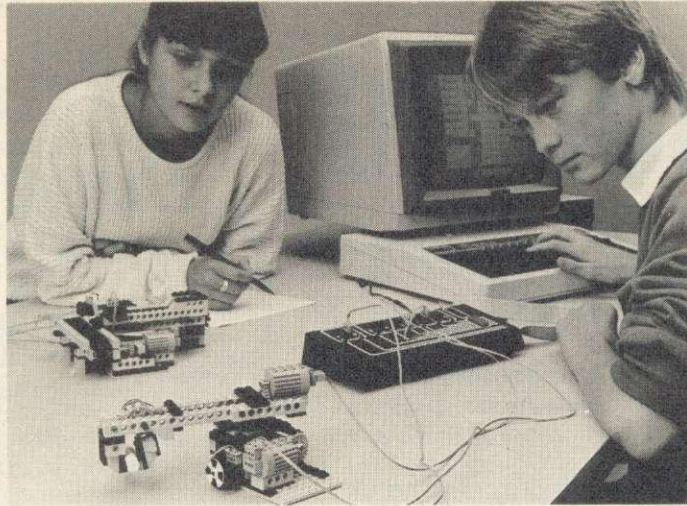

Robotic Lego

Lego has moved into the micro market with a new series of robotics kits, pictured left.

Designed for schools, the kits will be sold through specialist dealers. They are based on the technical Lego system which includes gears, motors, pulleys and other mechanical components as well as the usual bricks.

The software is called *Lego Lines*, and is designed to provide a painless introduction to setting data lines. The eight lines of the user port can be set and monitored and their status is displayed on the screen as coloured squares. The interface is a simple switching device providing six output and two input lines. The status of all eight lines is displayed by LEDs on the unit.

A typical outfit for three pupils, including software, interface, teacher's guide and student materials, as well as a load of bricks, is expected to sell for around £200. For more details contact Lego UK Ltd, Ruthin Road, Wrexham, Clwyd LL13 7TQ. Tel: (0978) 266949

Beebs create jobs

A pioneering project with BBC micros is putting severely handicapped people back to work.

It started three years ago at Stoke Mandeville and Oldstock hospitals, and boosted the number of patients finding jobs tenfold.

Dr Julia Schofield, herself blind, started the project by suspending BBC micros on special cradles above patients who were confined to bed in traction. The patients had severe spinal injuries and the first thing they did was to read about their condition from text files created with Microtext.

Games and wordprocessors

were added with tutorial discs. From playing games and writing letters, patients soon gained computing skills to earn them jobs.

Now 40 patients are back at work. The success stories include the former helicopter pilot who is now running a publicity company, and the one-time building apprentice who provides an estimating service for builders and plumbers.

Dr Schofield has expanded the scheme to four other hospitals in Britain and is also working in Australia, Canada and the far East.

Julia Schofield, 16 King St, Richmond, Surrey TW9 1ND.

POST A PROBLEM

AS a result of pressure from readers, *Acorn User* now guarantees a fast reply service for enquiries. Your answer will be returned within 10 working days for just £2 (includes VAT), or your money back.

The idea is simple. Just write out your problem, fill in the coupon (right), and send both off to *Acorn User* with a stamped addressed envelope and cheque or postal order for £2. (If you want recorded delivery, add the cost of this on. The same goes for overseas readers.) Include as much detail as possible and a disc or cassette if a program is involved - with enough space to record any corrected listing.

We will then answer the problem and return all material received - within a guaranteed 10 working days from receipt. If we fail to match this promise your cheque or postal order will be returned with the answered question. If we cannot answer the problem, the cheque will be sent back to you.

If you want advice on hardware or software, or a list of addresses, send us your problems.

ACORN USER READER SERVICE
141-143 Drury Lane, London WC2B 5TF

Name

Address

.....

.....

..... Postcode

Daytime phone number.....

I enclose a cheque/postal order for £2 and an sae with my problem.

OFFICE USE ONLY Date in:

Date out:

Answered by:

Announcing a Great New Deal for all Primary and Secondary Schools

INTRODUCING

**SUBSTANTIAL REDUCTIONS
ON ALL PLOTTERS**

Plotmate is recognised by many educationalists as one of the most sophisticated and practical plotters available at its price.

Now Primary and Secondary schools throughout the UK can reap the many benefits obtained by using PLOTMATE as an aid to computer based teaching at a cost which is lower than ever before.

This tremendous offer comes about as a result of the unique LINEAR GRAPHICS' EDUCATION SUPPORT SCHEME (ESS).

ESS has been devised and launched by Linear Graphics in order to provide the educational environment with the best possible value for money when purchasing this highly versatile extension to their computer graphics systems.

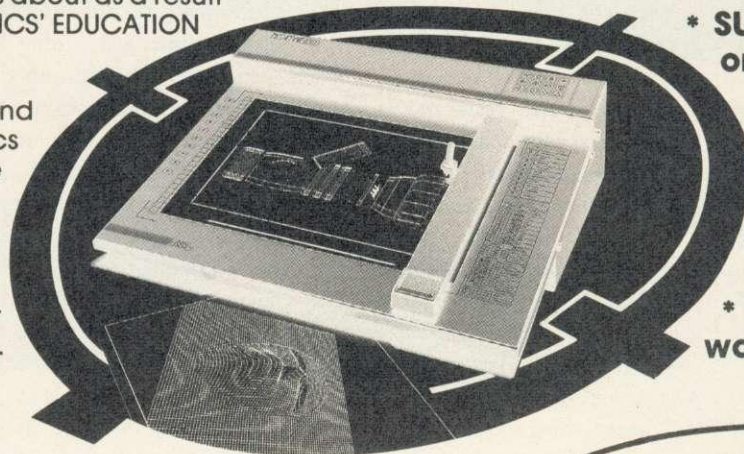

Under the ESS the following features become available:

- * **SAVINGS of up to 30% on normal prices.**
- * **FREE training available.**
- * **SUBSTANTIAL discounts on all Linear Graphics Software packages.**
- * **FULL support and service from the manufacturer.**
- * **TWELVE months warranty.**

COMPARE THESE PRICES!

PLOTMATE A4	£224 a saving of 25%
PLOTMATE A4M	£299 a saving of 25%
PLOTMATE A3 (with free Cadlink Disk and Plotmate ROM)	£299 a saving of 30%
PLOTMATE A3M	£426 a saving of 25%
SCANNER	£120 a saving of 20%
UPGRADE KIT A3 TO A3M	£150

PLUS save 20%-25% on all plotting accessories.

All prices are ex VAT.

PLOTMATE

LINEAR GRAPHICS LTD

28 Purdeys Way Rochford Essex SS4 1NE
Tel 0702 541663/4/5 Telex 995701



PLOTMATE Graphics Plotters are British manufactured products and approved by ILEA.

Please rush me information on Linear Graphics' Educational Support Scheme. I am particularly interested in (please indicate).

NAME _____

POSITION _____

SCHOOL/AUTHORITY _____

ADDRESS _____

TELEPHONE _____

'Phase out Basic in schools'

by Bill Penfold

Classroom computers should stop using Basic according to a report commissioned by the Government, which says it is time micro education moved on to more powerful languages.

The advice has come from the Advisory Council for Applied Research and Development - ACARD - which has completed a detailed and highly critical analysis of the future of the British software industry.

Most of the report concentrates on the bleak prospects of the small and diverse British industry in competition with the increasing might of the American giants and other foreign rivals. But ACARD also produced a handful of recommendations for micro education.

For starters, the 12-strong team

of experts called on schools to teach touch typing and 'mouse' skills as basics. It also recommended more teaching of mathematics relevant to understanding Information Technology.

It suggested that Computer Studies for pupils under 16 should be based on sound problem analysis and structured program development. But the experts made it clear they want to see an end of Basic, including the Beeb's.

'The teaching of Basic should be phased out as more powerful systems become available,' they maintained.

The ACARD working party included representatives of software houses, INMOS, the Alvey Programme, British Aerospace and Oxford University's programming research group.

Its overall conclusion on the prospects for the future of the British software industry was one of gloom. 'Foreign companies and multinationals will dominate the world and UK markets in the 1990s,' the report predicts. 'The UK market alone is too small to sustain a world class software industry.'

To survive, the experts have advocated much more training in computing skills, from the boardroom to the shop floor.

Part of that training is clearly seen as starting in the classroom. As a start, it proposes the construction of a common core syllabus for Computer Science at A-level. This should include 'a good groundwork in the mathematical aspects of software engineering, as well as its practical application'.

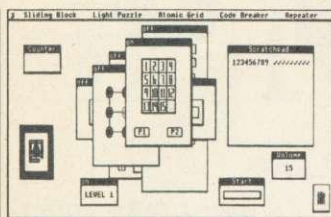

Play games with your mouse

Advanced Memory Systems, the company that produced the AMX mouse, has taken a break from business and graphics and has launched games designed to work with its popular rodent.

AMX Mind Games is a collection of five puzzles and brainteasers. It includes a sliding block puzzle, memory and code-breaking games (see screen dump above). In contrast, *AMX Zap Zone* is straightforward arcade action, but with all movements controlled via the mouse.

More details on these products are available from AMS, 166-170 Wilderspool Causeway, Warrington WA4 6QA. Tel: (0925) 413501/2/3.

DIY 3In drives

Some new and very inexpensive disc drives have been announced by Matmos. But you will have to have a certain amount of interest in DIY to make use of them.

The drives are 3in, 40-track models, giving an unformatted capacity of 250k per side. A single sided drive costs £29.95 and double sided is £39.95, plus a data lead at £10.

However, the drives are uncased and come without a power supply, although cases can be supplied and the company will advise on suitable power units.

Until now, 3in discs have been hard to get hold of but rumour has it that large stocks are on the way. The main problem will be a lack of commercial software in this format, but that may not bother home programmers.

Details on the drives are available from Matmos Ltd, 1 Church Street, Cuckfield, West Sussex RH11 5JZ. Tel: (0444) 414484.

Download hi-res graphics

High resolution graphics screens can now be downloaded from Prestel. The Mouselink section of Tubelink, which is found on the Viewfax database, is providing pictures created with packages like *AMX Super Art* and *Pagemaker*, which you can download to disc for later viewing.

The software that has made this possible is a machine-code compaction routine developed here at *Acorn User*. This means that only 1-2k of data is transmitted, rather than 20k. A decompaction program is available for downloading, along with the picture files.

Users are also encouraged to submit their own works of art. The screen files should be on disc, and sent to Mouselink Pics, PO Box 641, London NW9 8TF. Mouselink can be found on Prestel on page 2582182.



Graphics screens via Tubelink

Computers and health

A conference covering the use of computers in healthcare education and training is being held at Keele University in September. CBT '86 is the first conference of its kind and aims to cover subjects ranging from management techniques to the use of interactive video.

The conference will look at techniques such as computer managed learning, expert systems and artificial intelligence, and communications and information sys-

tems. Delegates are expected to include health service managers and senior teachers from the caring and remedial professions (nurses, occupational therapists and the like).

The conference runs from 22 to 24 September and a total of 280 places are available. Further details can be obtained from Stephen Ward, 164 Windsor Road, Ashton-in-Makerfield, Wigan WN4 9ES. Tel: (0942) 712385.

New SRAM group

A user group for Solidisk owners has sprung up in Scotland. Calling itself Solinet, the group aims to circulate a monthly newsletter on disc containing articles, hints and tips on sideways RAM.

Membership is free, although members are asked to submit their own discs in order to keep costs down. For more information contact Andrew James, 6 Torrinch Drive, Balloch, Dumbartonshire GB3 8JL.

USER GROUPS

LONDON

London. Association of London Computer Clubs: Robin Bradbeer, Polytechnic Of North London, Holloway, London N7 8DB
London. Association of Computer Clubs: Rupert Steele, 12 Philbeach Gardens, London SW5 9DY
London. Radio Amateur Micro User Group: contact by bulletin board No 86300198
East London. SOBAT Computer Club: Mr T. A. Kayani, 12 Calderon Road, London E11 4EU.
Tel: 01-556 5423
North London. BBC Micro Users Group: Mr Ric Keyworth, 'The Penthouse', 4b Kilburn High Road, London NW6 5UL.
Tel: 01-734 9235
North London. North London BBC Micro User Group: 82 Hornsey Lane, London N6 5LU
Tel: 01-263 6760 (eves)
Wandsworth. Wandsworth Computer Club: C. Kendrick, Earlsfield Library, Magdalen Road, London SW16
West London. Personal Computer Club: Chris, tel: 01-743 1579; Steve, tel 01-540 6271; Blue, tel 01-579 5415

SOUTH-EAST

Aylesbury. BBC Micro User Group: Aston Clinton County Combined School, Twitchell Lane, Aston Clinton, Aylesbury, Bucks HP22 5JJ
Tel: 0296 630276
Bognor Regis. Bognor Computer Group: E. R. Piper, 2 Ely Gardens, Aldwick Park, Bognor Regis, Sussex PO21 3RY
Bracknell. Bracknell Primary Schools Computer Users Group: D. Donaldson, Wildridings County Junior School, Netherton, Bracknell, Berks RG12 4DX
Brighton, Hove & District. Brighton, Hove & District Computer Club: J Smith, 30 Leicester Villas, Hove, E. Sussex BN3 5SQ
Bucks. South Bucks Acorn Computer Club: David Park, 160 White Hill, Chesham, Bucks HP5 1AZ
Tel: Chesham 783097
Camberley. Camberley Computer Users Club: David Crosby-Clarke.
Tel: Crowthorne 771590,
Prestel mailbox 344771590
Carshalton. Acorn Atom User Club: Kevin Roll, 66 Shaldon Drive, Morden, Surrey
Tel: 01-540 5282
Caterham. Computer Club: Caterham Leisure Centre, Godstone Road, Caterham, Surrey CR3 6RE.
Dartford. CP/M User Group: Diana Fordred, 72 Mill Road, Hawley, Dartford, Kent
Tel: 0322 22669
Guildford. West Surrey Computer Club: Jan Spencer, 52 Lindfield Gardens, Guildford, Surrey GU1 1TS.
Tel: 0483 63512
Harpenden. Harpenden Microcomputer Group: P. Cowley, 36 Southdown Road, Harpenden, Herts AL5 1PG
Harrow. Harrow Computer Group: Bazyle Butcher, 16 St. Peter's Close, Bushey Heath, Watford WD2 3LG
Tel: 01-950 7068
Ilford. ILBUG: Peter Jones, 1 De Vere Gardens, Cranbrook, Ilford, Essex IG1 3EB.
Tel: 01-554 9825
Iver. Iver Computer Society: John Haigh, 11 Collinson Walk, Ford's Farm, Colcot, Reading, Berks RG3 5ZJ
Tel: 0734-417534
North & Mid Essex. User Group (NAMEBUG): Andy Purkiss, 12 Palm Close, Witham, Essex.
Tel: 0376 515609
Prestel: 376515609
Reading. Reading User Group (RUG):
Tel: Richard Rowlands,
Tel: Reading 596825 (eves)
South East Essex. BBC User Group (SEEBUG): Miss J. Lines, 97 Oakhurst Drive, Wickford,

Essex SS12 0NW
Tel: 03744 63396
Sutton. Sutton Library Computer Club: The Secretary, 21 Village Row, Sutton, Surrey SM2 6JZ
Tel: 01-642 3102
Welling. Computer Users Club: Tony Latham, 69 Hadlow Road, Welling, Kent DA16 1AX

SOUTH & SOUTH-WEST

Alton. Alton Computer & Electronics Society: Kevin Weatherhead, Sheen, Old Odiham Road, Alton, Hants GU34 4BW
Tel: Alton 87478
Bristol. Format 40/80 Club: BBC Disc User Group, Peter Hughes, 5 Marsh Street, Bristol BS1 4AA
Tel: 0272 799979
Fareham. Porchester & Fareham Computer Club: Simon Ward, 9a East Cams Close, Downend, Fareham, Hants PO16 8RP
Gosport. Borough of Gosport BBC Users Group (BOGBUG), Graham Dubber, 128 Wych Lane, Gosport, Hants PO13 0TE
Tel: 0329 282221 (evenings)
Radio. AMRAC (Amateur Radio and Computers): Mr T. Triggel, Gleness, East Boldre, Brockenhurst, Hants SO42 7WD
Tel: 0590 612130

MIDLANDS & ANGLIA

Boston. Boston Acorn Computer Users Club: J. C. Goodwin, 245 Church Green Road, Fishloft, Boston, Lincs PE21 0RP
Burton-on-Trent. Beeb Users' Group (Bug Club): Mrs Linda Yeomans, 13 Regent Street, Church Gresley, Burton-on-Trent, Staffs DE11 9PL
Tel: 0283 216445 (eves)
Cambridge. Bottisham Acorn User Group: Peter Rank, tel Cambridge 812080, or Gerald Wilcockson, 19 Gallows Hill, Saffron Walden, Essex CB11 4DA
Tel: Saffron Walden 23793
Derby. The Derby Microcomputer Society: F. Taylor, Secretary, c/o 5 Park View Close, Allestree, Derby DE3 2GH
Tel: Derby 559334
Glossop. Glossop Computer Club (Derbyshire): T. S. Fox, 4 Park Lane, Little Hayfield, Stockport, Cheshire SK12 5NW
Tel: 0663 44260
Huntingdon. RAF Personal Computer Association: Sqn Ldr J. A. Upham, Man S (ADP), HQ RAFSC, RAF Brampton, Huntingdon PE18 8QL
Norwich. Amateur Computer Club: Andy Leeder, Church Farm, Stratton St Michael, Norwich NR15 2QB
Norwich. Norwich & District BBC Microcomputer User Group: Roy Street, Church Farmhouse, Themelthorpe, Dareham, Norfolk NR20 5PS
Tel: Foulsham 579
Nottingham. Micro Club
John Day, 8 Warkton Close, Chilwell, Notts NG9 5FR.
Tel: 0602 225660
Prestel: 602225660
Redditch. Redditch Computer Club: Anthony Green, 14 Radway Close, Redditch, Worcs B98 8RZ
Tel: 0527 61434
Stoke. POTBUG BBC User Group: J. Forest, 50 Cliff Street, Smallthorpe, Stoke-on-Trent, Staffs Tel: 818430
Stratford. Stratford Computer Club: Chris Parry, 15 Kipling Road, Stratford-on-Avon
Tel: 0789 68080
Suffolk. West Suffolk BBC Micro Users' Club: Antony Hurden, 14 Plovers Way, Bury St, Edmunds, Suffolk IP33 2NJ

NORTH-WEST

Cheshire. Mid-Cheshire Computer Club: Michael Christie, 496 The High Street, Winsford, Cheshire
Cumbria. West Cumbria User Group: P. Majid, Tel: 0946 62732 or
K. Purkiss, Tel: 0946 66586
Liverpool. Mersey BBC User Group: Nik Kelly, 56 Queen's Drive, Liverpool L4 6SH
Rochdale. Rochdale BBC Micro User Group: c/o 6 Dunbar Grove, Darnhill Estate, Heywood, Lancs OL10 3QJ
Wirral. Wirral Micro Users Club: David Walsh, 28 Priory Close, Bebington, Wirral, Merseyside L63 3EG

NORTH-EAST

Huddersfield. Huddersfield BBC Micro User Group: S. Gill, 21 Mayfair Avenue, Swood, Halifax, W. Yorks.
Tel: 0422 73058
Hull. Forum 80: 421 Endike Lane, Hull HU6 8AG
Hull. MUSE (for teachers): PO Box 43, 231/2 Friary Chambers, Whitefriargate, Hull HU1 2HD.
Tel: 0482 20268
Keighley. Keighley Computer Club: Colin Price, 'Apple Garth', The Hob Hill, Steeton, Keighley, W Yorks
Tel: 0535 54738
Newcastle. Newcastle & Washington BBC User Group (NEWBUG): Gary Bowmaker, c/o Washington Town Centre Library, The Galleries, Washington, Tyne & Wear
Tel: 0783 813175 (eves)
Sheffield. Parsons Cross BBC User Group: Andrew Grant, 28 Rokeby Road, Sheffield S5 9FU.
Tel: 0742 461203
S Yorks. South Yorks Personal Computer Group: Bob Hindle, 139 Penrhyn Road, Sheffield S11 8UP
Wakefield. Wakefield BBC Micro User Group: PO Box 65, Wakefield, West Yorkshire WF2 6YZ

SCOTLAND

Econet. User Group (Scotland): c/o Michael Ryan, Balkeerie Cottage, Eassie, by Forfar, Angus
Central Scotland. BBC User Group: D. Davidson, 1 Roxburgh Place, Larbert, Stirlingshire FK5 4UE
Tel: 0324 558692
Inverclyde. Inverclyde BBC Micro Users Club: Robert Watt, 9 St John's Road, Gourcock, Renfrewshire PA19 1PL.
Tel: Gourcock 39967

WALES

Cardiff. Cardiff BBC Computer Club: Geoffrey Barker, 2 Whitcliffe Drive, Penarth CF6 2RY.
Tel: 0222 701023

N. IRELAND

Belfast. Belfast Computer Club: Andrew White, 19 Greenpark Drive, Markethill, Co. Armagh, BT60 1PX

OVERSEAS

Australia. BBC Users Group of Canberra: PO Box E58 Queen Victoria Terrace, ACT 2600
Australia. Beebnet: M. A. Cowley, PO Box 262, Kingswood, South Australia 5062
Australia. Ozbeeb Sydney, meetings North Ryde. PO Box 1030, Parramatta 2150.
Tel: day 635 4868, eve 868 4455
Australia. Dapto BBC User Group: PO Box 447, Dapto, NSW 2530
Canada. Atom Users Group of Canada: John

Wood, 812 Cabot Trail, Milton, Ontario L9T 3M8

Canary Islands (Spain). BBC Micro Club Tenerife: PO Box 560, 38000 Santa Cruz de Tenerife
Eire. Irish Amateur Computer Club: Austin Laughan, 35 Monastery Drive, Clondalkin, Dublin 22
Tel: 01-593112 (eves)
Eire. OIFIG (Official Irish Forth Interest Group): c/o Hugh Dobbs, Newton School, Waterford
Finland. Arjen Raateland, Hoepatie 10A21, 00440 Helsinki 44
Tel: 90-5625027
France. Club Informatique Assevent: Claude Laurent, 1 rue du Marechal Leclerc, Assevent 59600
Tel: (27) 652294
Greece. Microclub: C. Mantzavinatos, 17 Stournara Str, 106 82 Athens
Tel: 01 3640.675-6
Hong Kong. Acorn Computer Users Society of Hong Kong: PO Box 13330, Central PO, HK
Malaysia. Sabah Computer User Group: c/o Albert Vun. PO Box 69, Kota Vun, Sabah, Malaysia
Malta. BBC Micro Users Club (Malbeeb): Ray C. Zammit, 20 Oleander Avenue, Santa Lucia
Netherlands. Big Ben Club: J W Vuurpijl, Hein Baderstraat 36, 2171 XP Sassenheim
New Zealand. BBC/Acorn Computer User Group of NZ: PO Box 9592, Wellington
New Zealand. Christchurch BBC & Electron Users Group: Mrs Rebe Nolan, 87 Palmers Road, Christchurch 9
Norway. BBC INFO: Horten Ingenlorhogskole, Skippergt. 6, 3190 Horten
Norway. Skandinavien BBC User Group: Frans-Otto Hendriks, Ludvig Karstensvei 14, 1064 Oslo 10
Pakistan. BBC Users Group. Capt Z A Kidvai. Tel: Karachi 540986
South Africa. Acorn Atom Users Group: J G Dowling, 27 Orbi Avenue, Van Riebeeck Park, Kempton Park 1620
South Africa. Pretoria BBC Users Group: Stan Miller, PO Box 117, Montana 0151
South Africa. Tygerberg BBC User Group (Tygerbug): R P Donovan, 16 Bakker Street, Welgemoed, Bellville 7530
Tel: (021) 953 2210
Sweden. BBC User Group: Anders Wickman, Folkungagatan 58, 116 22 Stockholm
Tasmania. (BBC Users Group) Tasbeeb: Box 25 PO, North Hobart 7002
Tel: 002 342704

SPECIAL INTEREST

Accounts. BEEBACC: Brian Pain, 40a High Street, Stony Stratford, Milton Keynes.
Tel: (0908) 564271
Adventure. International Adventure Club: Simon Martin Clarke, 10 Ennis Close, Harpenden, Herts AL5 1SS
Bulletin Boards. Forum 80: 421 Endike Lane, Hull HU6 8AG
CP/M. CP/M User Group: Diana Fordred, 72 Mill Road, Hawley, Dartford, Kent.
Tel: 0322 22669
Disc Users. Format40/80 Club: Peter Hughes, 5 Marsh Street, Bristol BS1 4AA
Education. Micros and Primary Education (MAPE): c/o Mrs G Jones, 76 Sudbrooke Holme Drive, Sudbrooke, Lincs LN2 2SF
Electronics. Alton Computer & Electronics Society: Kevin Weatherhead, Sheen, Old Odiham Road, Alton, Hants GU34 4BW
Tel: Alton 87478
Heraldry Society. Colin Forrester, 5 Hook Road, Epsom, Surrey KT19 8TH
Logo. British Logo Users Group (BLUG): Richard Olney, c/o London Technology Network, 86-100 St Pancras Way, London WC1

Try us for quality, service and prices



ROCKFORT

A Trading Division of Vignesh Ltd.

Manufacturer and distributor of Rockfort disk storage systems

**SPECIAL
SUMMER
OFFER**
**FREE
M.F.10 Box
with orders
over £20.00**

DISK STORAGE

Prices include P&P



**M.F. 50
Floppy
Disk Box**
Holds 50 -
5 1/4" Disks
£9.50

**FREE
M.F. 10**
Buy one and get
one free

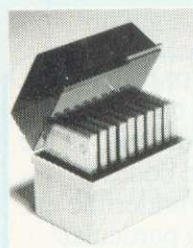

**M.D. 12/30
Micro
Disk Box**
Holds 12 to 30
3 1/2" Disks
according to
thickness
£7.85



**M.F. 10
Floppy
Disk Box**
Holds 10 -
5 1/4" Disks
£2.75

REG. DESIGN

ROCKFORT LABEL 5 1/4" FLOPPY DISKS

Prices include VAT and carriage

10-SS/DD 48tpi in MF10 box	£12.80
10-DS/DD 48tpi in MF10 box	£14.80
10-DS/DD 96tpi in MF10 box	£19.55
25-SS/DD 48tpi in MF50 box	£25.80
25-DS/DD 48tpi in MF50 box	£29.30
25-DS/DD 96tpi in MF50 box	£39.35
50-SS/DD 48tpi in MF50 box	£40.00
50-DS/DD 48tpi in MF50 box	£46.40
50-DS/DD 96tpi in MF50 box	£64.80

ROCKFORT LABEL DISKS FEATURE:

- Individual sleeves
- Write protect notch
- Hub rings
- Full set of labels (and write protect tabs)
- Meets all ANSI specifications
- Fully guaranteed

**FREE DISC DRIVE
WITH EVERY**

BBC Master 129K

£460 including VAT & carriage

Limited stocks
of Sinclair pocket TV
£89.00 inc. VAT
For use in UK
and abroad

CENTRONICS PRINTER SPECIALISTS

The Great Little Printer GLP range
(for use at home and office)

GLP 1

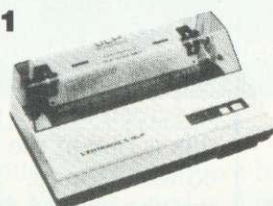

only £109 + VAT

A very compact, simple to operate dot-matrix printer
Printing speed 36cps in draft and 10cps in NLQ
Complete with tractor feed and parallel interface

GLP II - Improved version of GLP1

Fast draft output 100cps, 25cps NLQ, IBM PC and Epson FX compatible,
4k input buffer, better reliability.
With both serial RS232c and parallel Centronics interface.

NEW LOWER PRICE £139 + VAT

CENTRONICS PROFESSIONAL PRINTERS

HORIZON HPC-80 or CANON PW-1080A (10% slower)

Near letter quality printing at 34cps in true typewriter style font. Fast
draft 180cps, high res graphics,, tractor and friction feed standard
£233 + VAT

Other computers and peripherals available please phone or write for a
free catalogue.
Please add £6 carriage by Securicor for printers.

PRINTER RIBBONS

Prices include VAT and carriage

Centronics GLP	£4.00
Epson LX80	£3.80
MX100/FX100	£6.50
MX80/FX80	£4.20
Seikosha GP80	£5.20
GP100	£5.70
GP250	£6.85
Brother HR 15 M/S	£6.90
HR 15 Carbon	£4.80
Juki 6100	£3.45
IBM 82 (High yield)	£3.80
OKI 80/82	£3.80

LISTING PAPER

60 grams micro perf 11" x 9 1/2" 1000	£9.00
2000	£15.00

**TO ORDER - Please complete the
coupon below and send to us or
call us ON 01-203 0191 TO USE
ACCESS/VISA CARDS**



ROCKFORT PRODUCTS

81 Church Road, Hendon, London NW4 4DP

Please supply the following: Price inc. of
Qty. Description Carriage

.....
.....
.....
.....
Name

Address

..... Postcode

TRADE ENQUIRIES INVITED For Sinclair and BBC spares please call

INTER-WORD

INTER-WORD is the third in the ROM-LINK series of application programs for the BBC Micro-computer and this is the most ambitious suite of programs to be written for this machine. Each part of the suite offers a superior alternative to the competition. As a complete integrated suite of programs there is nothing better available for any micro computer.

INTER-WORD is the newest and the most comprehensive word processor ever produced for the BBC Micro.

- Part of the only truly integrated suite of programs for the BBC micro. This enables **INTER-WORD** to run alongside the other members of the ROM-LINK family such as **INTER-SHEET**. Multiple documents (together with sheet data etc.) can be held in memory at the same time and data transferred from one to another.

- Truly WYSIWYG. i.e **INTER-WORD** shows an accurate screen representation of the final printed page at all times.

- Supplied on a special 32K ROM, the chip is compatible with all machines.

- Supports 40,53,80 and 106 column screen modes with either 25 or 32 lines on screen.

- Compatible with BBC B, B+, Master, Aries, Watford and now Solidisk shadow RAM boards.

- Multiple column printout and multiple copy options.

- Mail merging facilities built in. Allows merging from another **INTER-WORD** document or from other **INTER** programs such as **INTER-BASE**.

THE NEW WORDPROCESSOR FOR THE BBC MICRO



The ROM-LINK suite, of which **INTER-WORD** is an important part, is a uniquely flexible set of integrated ROMs, compatible with all models of the BBC micro.



The first published review of **INTER-WORD** says:

"the most significant program since **WORDWISE**"

"**INTER-WORD** on the BBC Micro compares favourably with word processors costing five or ten times as much running on the IBM PC and the like."

"**INTER-WORD** was a real pleasure...a truly worthy successor to **WORDWISE**"

Gordon Taylor A&B Computing

- Built in support for different printers. There is no need for additional printer drivers, as the user can define the codes required for bold, underline etc. Once defined for a particular printer these codes can be saved for later use. Like **WORDWISE**, **INTER-WORD** also has the ability to send any control codes to the printer at any point in the line, thereby giving access to all its features.

- Powerful search and replace facilities include wildcards, and a case sensitivity control. There is also a quick 'go to' search option.

- Special attention has been paid to screen update speed, ensuring this is one of the fastest screen editors around. There is no waiting around for the text to reformat.

- If the page size is changed, or the margins are altered, all text is re-formatted to the new settings instantly.

- Any specified part of text, page or range of pages may be printed (or spooled to disc) via simple to select menu options.

- Fully compatible with DFS, ADFS, ECONET and any other Acorn compatible filing systems.

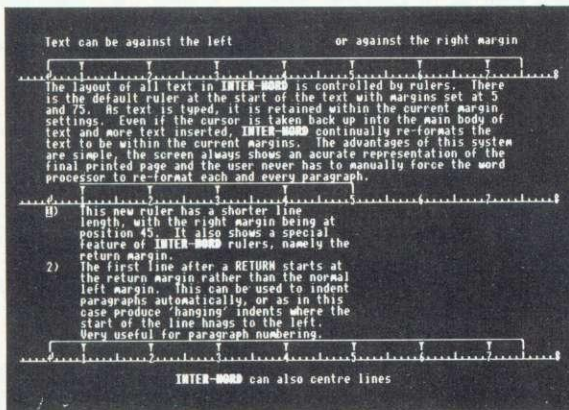

The format of text in **INTER-WORD** is controlled by rulers rather than embedded commands. A ruler can be inserted at any point simply by pressing a single function key. This ruler will affect the format of all text after it. By simply dragging the margin or tab indicators on the ruler all text controlled by this ruler is instantly re-formatted to the new settings.

INTER-WORD supports documents much larger than memory. This special 'multi-file' mode is both simple to use and far superior to other forms of continuous processing. By linking a list of files together **INTER-WORD** is able to treat these as if they were just one long piece of text.

The multi-file menu allows the insertion and deletion of any file and the printing of the whole document.

Multi-file	File list
Current document	CHAPT1 1
manual	CHAPT2 3
Current file	CHAPT3 10
CHAPT1	CHAPT4 17
.....	CHAPT5 24
Insert filename	CHAPT6 30
Remove filename	CHAPT7 37
Print document	INDEX 45
.....	
Create new document	

Save entire text

!BOOT	11	accounts
CHAPT1	CHAPT2	CHAPT3
CHAPT4	CHAPT5	codes
DUMP	EXAMPLE	flist
FSEL	INDEX	IWERRATA
IWERRATA1	IWORD	LABELS
LABLIST	LETTERS	LOAD
MANUAL	PRINTERS	RAMDUMP
RUBBISH	S1	

Select or enter filename

A special file selector is used whenever a filename is requested. Instead of having to remember and type the required filename, **INTER-WORD** will display a list of all the filenames. The user simply has to move the highlight to the required one and press RETURN.

When text is saved, all the current options are saved with it, including cursor position, screen mode and colours, current page layout etc.

Computer Concepts have been producing top quality software for the BBC machine since its launch. We designed and produced **WORDWISE** the most successful program ever produced for this machine. It is with this background that we can guarantee **INTER-WORD** is the best word processor for the BBC Micro. If you do not agree then just return it for a full, no quibble, refund. £49.00 + VAT (£56.35 incl)

EXPRESS ORDERS

Telephone our hotline with an order on Access or Barclaycard and we will dispatch it within 24 hours.

(0442) 63933

20% discount

Available to all **WORDWISE PLUS** owners. Simply quote your serial number, name and address when ordering direct. Discount price; £39.20 + VAT (£45.08 incl.)



Gaddesden Place, Hemel Hempstead, Herts HP2 6EX
Telephone: Hemel Hempstead (0442) 63933



COMPUTER SERVICING
(established since 1979)



WE REPAIR - ON THE PREMISES - QUICK TURNROUND

- ☆ BBC & ELECTRON (APPROVED SERVICE CENTRE)
- ☆ COMMODORE & SPECTRUM
- ☆ AMSTRAD & TORCH (APPROVED SERVICE CENTRE)
- ☆ DISC DRIVES, PRINTERS, MONITORS

MAIL ORDERS by phone Access and Visa Accepted
A Range of Hardware, Software, Joysticks, Leads, Interfaces
Chips etc, and Computer Paper always in stock

CROYDON COMPUTER CENTRE
29 BRIGSTOCK ROAD, THORNTON HEATH,
SURREY CR4 7JJ. Tel 01-683 2646

THIS NOTICE WORTH £2.50
AGAINST ANY PURCHASE OF HARDWARE OR SOFTWARE OVER £25

AA90



MICROWAY
Computer Centre



39 High Street, Rainham, Kent

MONITORS/PRINTERS/DRIVES

Microvitec 1451 Med Res	289.95
Philips Monochrome Monitor	94.95
DMP2000 NLO Printer	159.95
Star SG10 NLO	259.95
Cumana CSX400S 40/80/400K	154.95
Cumana CDX800S 40/80/800K	299.95
ATPL Rom Board	39.95
Replay 8271 or 1770	35.00

BBC FIRMWARE

Viewspell	39.95
Viewplot	TBA
Viewstore	59.90
CXR/CXR+	29.90
ISO Pascal	69.00
Intersheet	56.35
Interchart	44.85

BOOKS

Master Ref. Manual 1	14.95
Master Ref. Manual 2	14.95
Advanced Disc User Guide	12.95
Advanced User Guide	12.95

COMMUNICATIONS

Face Nightingale & Comstar	159.95
Autodial/Answer Board	56.35
ONE TO ONE subscription fee	25.00

Interword.....56.35
Advanced Disc Tool Kit...34.50
Advanced Disc Investigator.....28.75
Spellcheck III.....36.00

Acorn approved dealer
Fitting service available

Local purchase orders welcome
Please call if your item is not listed

Closed Wednesday

UK prices inclusive of VAT
P&P - Hardware 2.00. Others 1.00

TELEPHONE
0634-376702

NEW

LOW COST XYZ TABLES



250 x 400 x 80mm TRAVEL

XYZ assembly with 3 stepper motors and screw drives
£936 + VAT

Industrial version with ball screws £1,356 + VAT

Stepper motor driver rack with interface for
RS 232 £850 + VAT

INCREMENTAL ENCODER INTERFACE

reads positions of rotary or linear TTL encoder pulses direct to screen with one line of basic code per encoder



3 encoder P.C.B. assembled/tested/
uncased £300 + VAT

LEEWOOD DEVELOPMENTS LTD
UPTON, CAMBS
Phone (0480) 890860



AA285

ZONEFOUR LTD.

WE ARE DISKXPRESS AND MIMIC
DISTRIBUTORS FOR THE U.K.

DISKXPRESS IN FREE LIBRARY CASES			
New universal 5 1/4"	10s	£11.95	
SS	10s	£9.95	
DS 48TPI	10s	£10.55	
DS 96TPI	10s	£10.95	
MIMIC IN FREE LIBRARY CASES			
DS 96TPI	10s	£9.95	
Flipsided	10s	£10.95	
5 1/4" BULK DISKXPRESS			
SS	25s	50s	100s
	£18.00	£34.00	£60.00
DS 48TPI	£20.00	£38.00	£70.00
DS 96TPI	£22.50	£40.00	£75.00
Universal	£25.00	£48.00	£88.00
BULK MIMIC			
DS 96TPI	25s	50s	100s
	£21.00	£37.50	£70.00
Flipsided	£25.00	£48.00	£88.00
SONY			
3 1/2" DS	10s	£33.95	
UNLABELLED 3 1/2" IN LIBRARY CASE			
SS	10s	£17.95	
DS	10s	£22.95	
3 1/2" BULK DISKS			
SS	25s	50s	100s
	£40.00	£75.00	£140.00
DS	£50.00	£90.00	£175.00
STORAGE BOXES			
100 Lockable 5 1/4"			£9.95
40 Lockable 3 1/2"			£7.95

ALL PRICES INCLUDE VAT AND P/P
TO ORDER PLEASE CALL DIRECT DISK LINE:
ZONEFOUR, 65 CENTURY ROAD, LONDON
E17 6JA Tel. 01-523 2059

PLEASE CALL FOR BULK AND INSTITUTIONAL PRICES

AA295

WALTHAMSTOW MASTERS

BBC MASTER MICRO
ACORN PRODUCTS
DISC DRIVES
MONITORS
PRINTERS
SUPPLIES
SOFTWARE
REPAIRS

MICRO SERVICE

19 Walthamstow Business Centre
Clifford Road, London E17 4SX
Telephone 01-531 9070

AA277

SPIDER 2

REAL-TIME CONTROL FOR THE BBC MICRO

Watch the SPIDER!

- ★ Powerful new BASIC commands for invoking PROCs from the User Port, Serial Port or the Keyboard.
- ★ 8 independent countdown timers.
- ★ Easy to install with no soldering.
- ★ Comprehensive manual supplied.

New SPIDER 2 features

- ★ Special keywords for controlling the Serial Port.
- ★ Professional implementation of Foreground/Background processing.
- ★ Reaction timing and pulse trains accurate to 0.1 milliseconds!

from £65 including VAT

SPIDER 2 is a RAM/ROM combination which uses none of the BBC's memory, so BASIC programs are unaffected. The BBC B+ is fully supported and we supply a complete range of digital, analogue and serial interfaces for use with SPIDER using the 1MHz bus. Ask now for details.

Paul Fray Ltd
Willowcroft, Histon Road, Cambridge CB4 3JD
Telephone: (0223) 66529

AA211



SPIDER - stamps out I/O bugs

NOW AVAILABLE FOR BBC MASTER

DISCS

**AT LOW PRICES
IN PLASTIC LIBRARY CASES**

5 1/4"	10	3 1/2"	10
DDSD	£7.99	SS 135tpi	£15.95
DSDD (96tpi)	£9.99	DS 13tpi	£19.95

BULK DISKS AT CRAZY PRICES

5 1/4"	25	100
DS 96tpi	£14.99	£49.99
3 1/2"	25	100
DS 135tpi	£39.99	£149.99

BBC Master 128K	£429.95
BBC Master econet terminal	£369.95
Acorn 512 upgrade kit	£399.95
Epson RX100 +	£219.95
Epson LQ800	£529.95
Amstrad 8256	£419.95
Philips CM8533 Hi. res. mon.	£269.95
Mitsubishi 1404 monitor	£229.95

(all monitors come with cables for BBC)

CENTEC ELECTRONIC SYSTEMS LTD

47, Spur Road, Orpington, Kent BR6 0QT
Telephone 0689-35353



Please call for bulk and education prices



AA297

A New Concept in Software

Letters, Notes, Reports,
Articles, Books,
Ease creative writing with

BBC

SCRATCHPAD

BBC

The ideas organiser
for creative writers

Organise your thoughts and make the ideas flow

* A suite of programs based on scientific knowledge about our thought processes

* Written by an established author

* Icon driven

* Fully tube compatible

* Spool to your word processor files

* Completely user-friendly

* Single or double disk drives

SCRATCHPAD makes writing so much easier - all you have to do is add the words. "Certainly a clever idea . . . beats my sheets of A4" (Mirco User, Jan '86). "Well organised utility . . . valuable to writers . . . very useful indeed"

(Acorn User, June '86)

Price £24.95 (incl p&p)

INNOVATIVE SOFTWARE (AU)

41 Walter Road, Swansea

AA231

THE HACKERS HOLY GRAIL by Brian Sothcott

Send £12.50 today for your guide to the B.T. telephone network, finding unlisted phone numbers, writing auto dial software and other useful sources.

MicroChips, 56 Waterloo Road,
Freemantle, Hampshire (0703) 32729.

AA273

MASTERCOPY

. . . the selective copier you need for the BBC MASTER computer . . .

Dramatically reduces the time taken to copy unprotected discs,

DFS to ADFS, ADFS to DFS, DFS to DFS, ADFS to ADFS

using one or two, single- or double-sided drives.

An 84K RAM buffer enables many files to be copied in one pass with the minimum of disc swapping, and directories are created automatically as required. Files of any length are handled.

Supplied on disc, MASTERCOPY runs from sideways RAM and is invoked with a * command. The program re-installs itself in sideways RAM when copying is done, ready for later use.

The ROM image supplied can be used to blow your own EPROM too, for use in the MASTER's cartridge slots.

Typical time to copy all 31 files DFS to ADFS is under 2 minutes!

£12.95 on disc - £14.95 for ROM version (including postage etc.)

For the Model B and Master:

DESIGN 7 - the best Mode 7 designer on the market. Design any screen quickly and easily, from simple menus up to full viewdata-standard screens. Saves screens as automatically-numbered files (for screen dumps etc.), or will convert them to BASIC for use in your own programs. Hundreds in use. Only £8.95 incl. p&p.

DEFAX - a teletext emulator - now you can run your own videotex system with pages you design yourself. Up to 200 pages stored on an 80 track disc, or 100 on a 40 track. Incorporates a powerful carousel facility with animation effects. Built-in graphics dump. Beats all of the other 'FAX' systems for ease of use and versatility. Supplied on 2 discs. £24.00 incl. p&p

Please indicate whether 40 or 80 track discs are required.

ECONET versions of DESIGN 7 and DEFAX are available.

For further details of these products please ring 091-263 4026
Enquiries, cheques or P.O.s to

M/B Software

4 Arden Close, Hadrian Park, Wallsend, Tyne & Wear
NE28 9YB

AA278

PRINTERLAND

ORDERED TODAY
DELIVERED TOMORROW

UK's LOWEST PRINTER PRICES

NEAR LETTER QUALITY

EPSON LX80	£189.00	£217.35
EPSON FX88 +	£360.00	£414.00
EPSON FX 105 +	£455.00	£523.25
EPSON LQ 800	£515.00	£592.25
EPSON LQ 1000	£646.00	£742.90
EPSON LQ 1500	£715.00	£822.25
EPSON DX100 - SPECIAL OFFER:	£356.00	£409.40
EPSON JX-80 - SPECIAL OFFER:	£450.00	£517.50

FANTASTIC
VALUE

CANON PW1080A

160 CPS DRAFT
27 CPS N.L.Q.

£209 + VAT

QUENDATA £139 VAT

DAISY WHEEL PRINTER
18 CPS QUME
COMPATIBLE

PANASONIC KXP
1080U

100 CPS/20 CPS N.L.Q.
£159 + VAT

156 LONGWOOD GATE LONGWOOD HUDDERSFIELD
TELEPHONE: 0484 646048/9

AA288

£40.00 Cash Allowance for your old ROM Expansion Board when you trade in for the Fourmeg 256K or £10.00 reduction if you already have Solidisk DFS

The memory limit on the BBC Micro can now definitely be a thing of the past. The new Solidisk Fourmeg 256 board offers all you could wish for.

It has 256K of extra RAM, a superfast 4MHz CMOS processor, sophisticated memory management, sockets for high capacity ROMs and 48K of software in ROM. In fact, it contains even more devices than the BBC itself. It is compatible with most hardware add-ons — except Sideways ROM expansion, which explains why this special offer.

Fitting it is easy. You remove the existing processor from its socket and plug the new board in its place, push on three colour-coded wires, clip on two mini-hooks and it's ready. Switch on the computer and you will immediately see the difference.

The message "Solidisk 256K expansion (4MHz)" announces the new memory size and speed.

A switch at the back lets you select between the old (2MHz) and the new (4MHz) speed.

The BBC Micro at 4MHz easily surpasses the new MASTER 128K on benchmarks.

For example, it runs the benchmark using Basic 4 in only half the time taken on the MASTER 128K.

If you have too many ROMs to plug in at once, the Fourmeg 256 offers TWO ways out. First, it includes additional high capacity (and fast) ROM sockets. Moreover, two or four normal ROM images can be stored in one high capacity ROM chip (by "Vertical Paging") — so more can be made immediately available at your fingertips.

Secondly, ROM images can be stored on discs and loaded into any one of the eight Sideways RAM banks available. If you need more room in "languages" such as VIEW or BASIC, you may use any of the eight SHADOW RAM banks. No user memory is then lost to the screen, whatever the screen mode (while machine coded programs can access RAM right up to &FC00!).

Two frequent uses of the extra memory are as a RAMDISK or a printer buffer.

Star commands in the ROM can turn the extra RAM into a silicon DISK of 200K, compatible with both the Solidisk DFS and ADFS formats. The RAMDISK is at least 10 times faster than physical disc drives as it has no moving parts.

The printer buffer saves you time, it lets you use the computer while feeding your printer in the background.

In addition, the MANAGER ROM offers over 30 star command utilities to save time and effort using the computer.

To complement such a powerful product, Solidisk has arranged with Computer Concepts to bundle the famous WORDWISE PLUS wordprocessor ROM and manuals. This excellent product, worth £45.00 on its own, became the best selling wordprocessor for the BBC computer last year. All in all, the Solidisk Fourmeg 256 offers an unmatched combination of speed, power and built-in facilities, while still having room for even further expansion. It is the most logical next step for the owners of any Sideways ROM board or of Solidisk Sideways RAM, who can trade in their present boards for the excellent Fourmeg 256.

Yes! I want to take you up on your special summer offer

"I will pay only: (delete if not applicable) £135.00 instead of the normal price (175), I will send you my old ROM board when I have been satisfied with your Fourmeg 256.

£165.00 instead of the normal price, I already have your DFS installed in my BBC.

I also allow £3.00 for First Class Post.

If for any reason I am not entirely satisfied with your product, I will return it before 15 days and have all my money back (except postage if applicable)".

Name

Address

Access/Visa Account :

Send to:
Solidisk Technology Ltd
17 Swayne Avenue, Southend-on-Sea
Essex SS2 6JQ

We reserve the right to change prices and specifications without notice for improvement.



SOLIDISK has products to expand your BBC Micro inside out, so why hesitate, pick up the phone and ring this number:

**SOUTHEND
(0702) 354 674**

ASK FOR A BROCHURE

PRICE INCLUSIVE OF VAT

Stock

No.	Description	Price £	Post £
-----	-------------	------------	-----------

RAM/ROM EXPANSION

101	Basic Fourmeg board	30.00	3.00
102	FOURMEG WITH 32K RAM	69.00	3.00
103	32K Sideways RAM with S/W pack1	50.00	3.00
104	64K Sideways RAM with S/W pack1	80.00	3.00
105	128K Sideways RAM with S/W pk1	125.00	3.00
106	Fourmeg 256 with WW+	175.00	3.00

DISC UPGRADES

201	1770 Upgrade with 2.2 ROM	45.00	2.00
202	1770+8271 (DFDC) Upgrade 2.1 ROMs	60.00	2.00
203	ADFS ROM set (2.1)	20.00	2.00
204	Upgrade from DFS to ADFS (ret. ROM)	10.00	2.00
205	Solidisk 80 Track/DS disc drive	109.00	4.00
206	DUAL Drives + keyboard case	230.00	8.00
207	WW+, Single Drive, MP165, DDFS2.1	350.00	15.00
208	WW+, Dual Drive, K/B, MP165, DDFS	465.85	15.00

WINCHESTERS

301	20MB BEEB powered, ADFS ROM set	661.25	10.00
302	20MB Mains powered, ADFS ROM set	745.00	10.00
303	40MB Mains powered, ADFS ROM set	1148.85	10.00

MISCELLANEOUS

401	Linemaster ROM	10.00	2.00
402	Toolkit ROM	10.00	2.00
403	MD525 Diskettes (10)	16.00	2.00
404	27128-25 EPROMs (5)	20.00	2.00
405	27256-25 EPROMs (5)	30.00	2.00
406	UVIPROM (16K)	19.00	2.00
407	UVIPROM (32K) for 27256	21.00	2.00
408	EPROM ERASER	20.00	2.00

"If you have a good working BBC Model B already expanded with Solidisk DFS, or Disc Drives or Sideways RAMs, then this "MASTER PLAN" is designed for you"

The Solidisk MASTERPLAN is specifically set up to reduce financial burdens to all Solidisk loyal customers, as much as possible.

Fill in carefully the coupon below and send it to us. We will immediately send you a personalized quotation for upgrading your BBC B to the Master which we are sure you will find really hard to refuse . . .



SOLIDISK "MASTERPLAN"

NAME

ADDRESS

.....

.....

.....

.....

.....

: : REQUEST INFORMATION PACK

VISA/ACCESS

We reserve the right to change prices/specs without notice.

Please tell us about your BBC computer system . . .

ISSUE and AGE

Upgrades fitted inside:

1) Date by

2) Date by

3) Date by

Peripherals attached outside:

1) Date by

2) Date by

3) Date by

Service history:

: : has never gone wrong, never serviced.

: : Service history as follows:

.....

.....

.....

BLOCKBUSTER Disc Drive Sale

1986 BARGAINS AT 1985 PRICES

This amazing Opus summer sale includes top quality disc drives and our famous DDOS interface at unbelievably low prices. Just look at these price shattering offers.

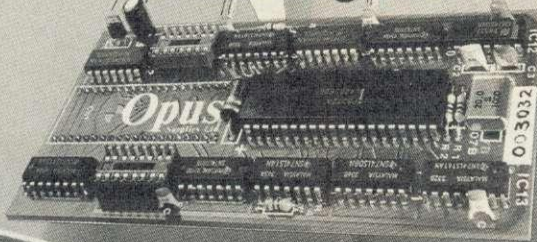

**ONLY
£159.95**
500K DUAL DRIVE SYSTEM
5 1/4" dual single-sided 40 track disc drive plus double density disc interface 350K formatted capacity.

**ONLY
£99.95**
250K SINGLE DRIVE SYSTEM
5 1/4" single-sided 40 track disc drive plus double density disc interface 175K formatted capacity.

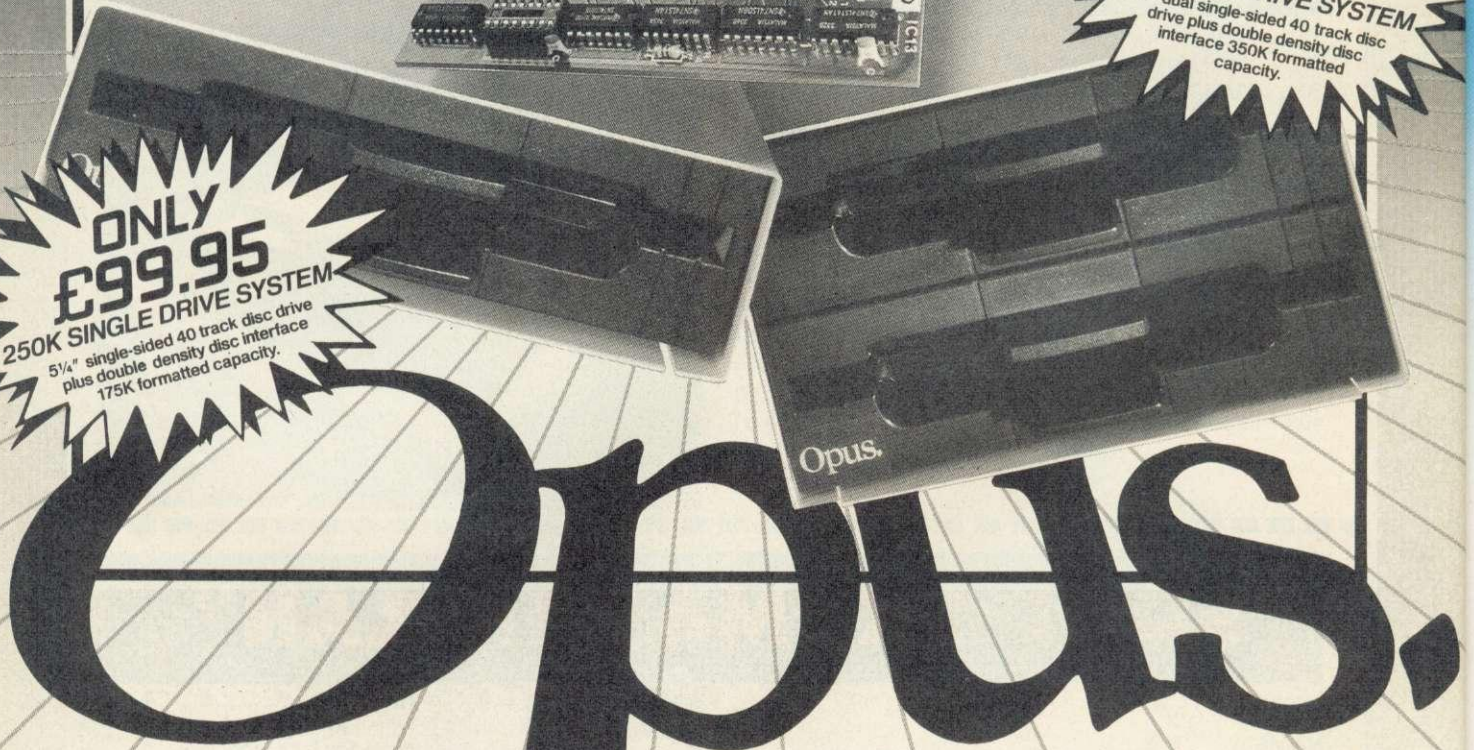

Opus.
Opus Supplies Ltd.

Opus Supplies Limited,
55 Ormside Way,
Holmesthorpe Industrial Estate,
Redhill, Surrey.

Please rush me the following: (All prices include VAT & carriage)

- Single Drive System(s) at £99.95 each
 Dual Drive System(s) at £159.95 each

(Please tick box where applicable) **AU**

I enclose a cheque for £ _____ or please debit my credit card account with the amount of £ _____

My Access Visa no. is: (please tick)

Name _____

Address _____

Telephone _____

These are complete disc drive systems for the BBC micro – No extras required. Both our systems combine the very latest in Japanese disc drive technology with the unbeatable Opus 2-year guarantee. With super reliable direct drive mechanisms, low power consumption and fast track to track access times they represent fantastic value.

Each drive is supplied with the easy to fit Opus DDOS – probably the most advanced double density disc interface available. It uses the same 1770 disc controller chip as the BBC B+ making it compatible with most leading software – phone for details. Utilities are included on ROM, the system handles tape to disc transfers and its powerful machine code operating system gives you up to 248 files. The perfect partner for any BBC disc drive system.

Our sale prices even include VAT, 2-year warranty and guaranteed 72-hour FREE delivery. You won't buy better, you can't buy cheaper, but hurry we can't hold these prices for ever! To order your system simply post the coupon or ring Opus now on 0737 65080 – we'll give you full details of the other disc drive bargains in our range. Generous education and dealer discounts – enquiries to Martin Brefitt on our main Opus number 0737 65080.

GO BANANAS

Suitable for virtually ALL computers with 5¼" drives whether single or double sided. If a single sided drive, then you will be able to get twice the storage as you can flip these over.



Only £8.65 exc VAT
(£9.95 inc VAT per ten-pack)

Specification:

- * Double Sided Double Density 40 or 80 track
- * Hub Reinforcing ring means TOTAL reliability
- * Truly REVERSIBLE with 2 notches & Index holes
- * TWICE the storage at HALF the cost!
- * Perfectly suitable for Double Sided Disk Drives
- * All our bananas are individually certified
- * Made to our specifications by a major manufacturer
- * Lifetime warranty on EVERY banana
- * You can't afford to keep driving to your disk shop with prices like these. Just pick up the 'phone & we'll have them at your door in a trice!

If you don't need disks today, just keep this ad.

* Crown exclusively by:

DISKING
FREEPOST

Liphook
Hants GU30 7BR

Tel: (0428) 722563 (24hr Order Hotline)

If coupon clipped - just call



Post To: DISKING FREEPOST Liphook Hants GU30 7BR
Tel: (0428) 722563 (24hr order hotline)

Please rush me _____ boxes of bananas @ £9.95 per box plus P&P @ £1.09 per box. Total £11.04 per box inc VAT. P&P is 86p/box for 3/5 boxes, 69p/box for 6-9 boxes. Ten boxes or more are POST FREE.

Official Government orders are welcome.

FREE 'Go Bananas' badge with every ten-pack

All orders despatched in 4 hours

Name _____

Address _____

Tel No. _____

I enclose cheque payable to DISKING, or please debit my ACCESS/VISA card No: _____

TWILLSTAR COMPUTERS LTD

FREE CATALOGUE and full price list. Call now for your issue.

Computers

MASTER 128
Complete With Internal Software £454.25
Master Turbo Upgrade £113.95
Master Econet Module £46.00
Master ET £373.75
Master 512 Upgrade £389.00
Master SC Upgrade T.B.A.
Eprom Cartridge £14.95
Reference Manual Part 1 £14.95
Reference Manual Part 2 £179.00
6502 Second Processor £379.00
Z80 Second Processor £125.00
Acorn Prestel Adaptor £135.00
Acorn Teletext Receiver £1250.00
Winchester Disk Drive 10 MBYTES £1850.00
Winchester Disk Drive 30 MBYTES £299.00
IEEE Interface £178.00
Music 500 £49.00

ECONET ACCESSORIES

100m Cable £89.00
Station Lead Set £29.00
Econet Starter Kit £99.00
Econet Bridge £199.00
Level 1 Fileserver 40 Track £99.00
Level 2 Fileserver 80 Track £235.00
Print Server Eprom £49.00

BBC Upgrades

64K Upgrade Kit £39.95
1770 Upgrade Kit £49.94
ADFS ROM £29.95
Disc Upgrade Kit £89.00
Econet Upgrade Kit £49.00
Speech Upgrade Kit £49.00
DNFS ROM £20.00

Monitors

MONOCHROME MONITORS

Phillips BM 7502 Green Screen £79.00
Phillips BM 7522 Amber Screen £95.00
Kaga KX 1202G Hi Res Green £120.00
Kaga KX 1203G Ultra Hi Res Amber £120.00

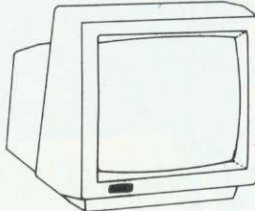

Hantarex Hx 12 Dark Gloss Screen high resolution monochrome monitor 12" Composite Video & Audio input £89.00

COLOUR MONITORS

Microvitec 1431 Std Res £201.25
Microvitec 1451 Med Res £270.25
Microvitec 1441 Hi Res £391.00
Microvitec 2030 Cs 20 Std Res £425.50
Microvitec 1431 AP Std Res £224.25
Microvitec 1451 Ap Med Res £293.25
Phillips CM 8501 STD Res Monitor with grey glass Screen RGB and Audio input £209.00

Special Package

The TCL All in One Word Processing Package contains a Master 128, View 3.0, Viewsheet, High Res Green Monitor, 800K Dual Drives with PSU, Quendata Daisy Wheel Printer together with a box of Discs, Paper, and all the Cables £914.25

Modems

NIGHTINGALE MODEM

Including Commstar and Comprehensive Manual £130.00
Auto Dial/Auto Answer Board £55.00
Auto Dial Utilities Disc £11.00
OBBS Bulletin Software £23.00

DEMON MODEM

With its Devilishly Clever features Auto Dial, Auto Redial, Auto Answer Full and Half Duplex European and USA Standards Complete with Power Supply Leads and Manuals Full Baud Rates Demon with BBC ROM £81.00
Dial Disc £4.95

MAGIC MODEM

with 300/300 Full Duplex, Auto Dialing RS232 & 5 LED's (Transmit Data-Receive Data) Carrier, Power & Data Direction £81.00



Now available Taxan Multipurpose Type Printer Buffer KIF-4308 compatible with any Centronics interface printer £149.00

Printers

DOT MATRIX PRINTERS SPECIAL OFFER

Juki 5510 - Gives you 180 CPS & NLQ Standards £269.00 Inc. VAT

...and that's not all! The Juki 5510 also has full graphics mode, two position 'dip-switch' (providing instant compatibility with both the Epson and the IBM Graphic Printer). Standard 2K memory (expandable to 14K) built-in Parallel Centronics interface and 8-switch international character sets. If you need colour too, the optional Juki 5510 Colour Kit gives you seven colours. £112.00

CITIZEN 120 D

With 120 CPS and 25 CPS NLQ comes with tractor and friction feed as standard. IBM end Compatible with TWO years Warranty £159.00

CITIZEN MSP10

The new MSP10 with 160 CPS Draft and 40 CPS NLQ. With TWO years Warranty £269.00

YOUR ONE STOP MEGA-COMPUSTORE FOR

Disc Drives

MITSUBISHI DISC DRIVES

User Friendly Disk Drives 100% BBC compatible slimline disc drives. All drives are supplied complete with formatting diskette, comprehensive users manual and all necessary cables. All drives are 40/80 Track switchable at the front and have two years warranty.

5 1/4" Drives without P.S.U.

MD 400A Single 400K Double Sided £118.00
MD 802C Dual 400K Double Sided £219.00

5 1/4" Drives with P.S.U.

MD 400B Single 400K Double Sided £135.00
MD 802E Dual 400K Double Sided £249.00

SPECIAL
MD 802D Dual 400K Drives horizontally mounted in a monitor stand to fit both the BBC B and the Master series. £289.00

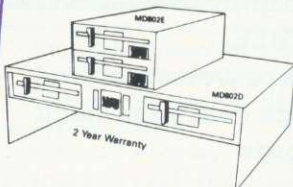

We are unable to list all the products that we stock - Please call for further details or visit our **NEW SHOWROOM**

Phillips CM 8533 Med Res monitor with dark glass etched screen composite video input RGB and Audio Input. £289.00

OUTSTANDING PERFORMANCE

OUTSTANDING VALUE

Just released by Hantarex 14" Colour Monitor Standard Resolution RGB PAL Audio Input (Inc. VAT) £189.00

SPECIAL OFFER

Mitsubishi 1404 Medium Resolution Monitor with 640 X 200 Pixels RGB available with IBM or BBC Leads. £229.00

Taxan Super Vision III

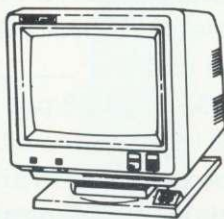

This display is designed for business use which provides both high-res monochrome (Green, Amber, and White reverse) mode and high-res Colour graphic mode all in one. £369.00

TV MONITORS

Phillips 1114 colour TV/monitor with 14" tube offering 10 Preselect channels RF CVBS and RGB inputs £199.00

SPECIAL OFFER OF THE MONTH

KX-P 1080 DOT MATRIX PRINTER

* NEAR-LETTER QUALITY PRINTING IN ALL PITCHES

* OPERATOR ACCESSIBLE PRINT MODE SELECTOR (Std./Pgm., NLQ, Comp.)

* FRICTION FEED AND ADJUSTABLE TRACTOR ARE STANDARD

* WORD PROCESSING FUNCTIONS (Justification, Centering, L&R alignment)

* PROPORTIONAL SPACE PRINTING

* HIGH RESOLUTION, DOT-ADDRESSABLE GRAPHICS

* UP TO 40 DOWNLOADABLE CHARACTERS

* COMMAND CODE COMPATIBLE WITH POPULAR PRINTER SOFTWARE

* PRINT SPEED, DRAFT: 100

NLQ: 20 COMPRESSED: 86

* 9 PIN PRINT HEAD

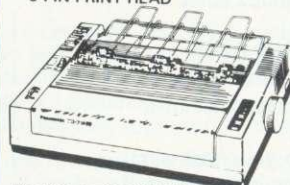

The Panasonic PX-P 1080 impact dot matrix printer is ideal for applications that require economical high quality printing. It offers a variety of print modes, all producing crisp clearly formed characters. Wide choice of print sizes includes semi-compressed and compressed (even in near-letter quality printing). Operator accessible print mode selector adds convenience. For a reliable printer at an affordable price, the KX-P 1080 is always a smart choice. £159.00

NEW STAR NL-10

Fine Near-Letter-Quality, 100% compatibility and total reliability all in one easy to use printer. For quality, ease of operation and dependability, nothing beats the Star NL-10. You get outstanding print quality at 120 cps in draft mode and 30 cps in near letter quality. Plus, the sleek NL-10 offers full compatibility with most popular computers through plug in interface cartridges. Just insert the appropriate plug in interface cartridge for your IBM-PC, Commodore, Apple IIc or other parallel computer and your Star NL-10 is ready to print. Touch a button on the control panel to set the print pitch (3 choices), to select the typeface and to print in either draft or NLQ mode. You can even set left and right margins, make top of form settings and control forward and reverse feed in the smallest pitch. £229.00

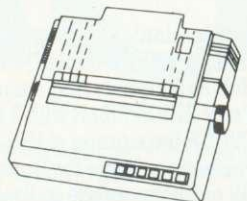

BROTHER M1109 NLQ

Printer 100cps Directional Logic Seeking Friction feed and secondary optional tractor feed £189.00

KAGA KP810

The 80 column printer with 140 CPS Draft and NLQ with friction and tractor feed offering 9 INt character sets. Long life cartridge ribbon and standard centronics interface. £249.00

visit our **NEW SHOWROOM**
Open 9am-6pm Mon-Sat
OPEN SUNDAYS 10-2
(From September 1st)

Printers

EPSON LX80

With 100 CPS draft and 16 CPS NLO and optional tractor adaptor and sheet feeder. This printer has a standard parallel connection and boards with other Epson serial Parallel boards with external dip switches for easy access and internal IK buffer. It offers a high specification at a low price. **£229.00**

EPSON LQ800

24 Pin Dot Matrix Printer offers a high 200 CPS draft speed and near letter quality at 67 CPS with high resolution graphics and a variety of fonts **£585.00**

ALSO AVAILABLE

Epson FX 85	£365.00
Epson FX 105	£495.00
Seikosha GP 50A (Parallel)	£69.00
Seikosha GP 50S inc.	£69.00
Printer V/F + cables	£249.00
Canon PW 1080A (NLO)	£379.00
Canon PW 1156A	£228.00
Brother EP 44	£189.00
Shinwa CP 80A	£240.00
MP 165	£240.00

DAISYWHEEL PRINTERS

QUENDATA DWP 1120
With optional tractor/sheet feeder and 13" paper width facility. This Daisywheel printer with 20 CPS has 96 character printwheel compatible with the QUME. Standard centronics interface.

(optional RS232 C)	£169.00
Brother HR 15 XL	£389.00
Juki 6100	£285.00
Juki 2200	£275.00
Juki 6300	£799.00

COLOUR PRINTERS

Canon PJ1080A **£440.00**

TRACTOR ADAPTERS

FX85	£33.00
LX80	£23.00
Juki 6100	£129.00
Juki 6300	£129.00
Quendata DWP 1120	£114.00
Brother HR 15	£95.00
LQ 800	£43.00

COMPUTER

BBC dust cover vinyl	£3.50
Data recorder complete	£24.95
BBC lead	£59.00
Tracker Ball	£59.00
GRAFPAD II	£59.00

JOYSTICKS

Voltmace 14b Handset	£14.95
3b Singlet	£12.95
3b Duoset	£19.95
14b Interface	£14.95
DRAWER Cassette	£5.95
DATAPAD Keyboard	£39.95

DISC STORAGE

10 x 5 1/4 Library case	£2.00
70 x 5 1/4 Lockable	£9.95

SERIAL INTERFACES

EPSON 8143	£34.00
JUKI	£58.00
CANON	£91.00
KAGA	£85.00
Epson 8148 + 2K buffer	£65.00

LISTING PAPER

11" x 9 1/2 2000	£14.00
Teletypewriter Roll	£4.50
Teletypewriter Roll Holder	£14.00

PRINTER LABELS

1000 90 x 36mm 1 across	£5.70
1000 90 x 36mm 2 across	£6.70
1000 90 x 36mm 3 across	£7.70

PRINT FEED SYSTEM

Revolutionary low cost Printer Feed System tidies up all Micro Desks—No more paper on the floor. **£35.00**

MONITOR ACCESSORIES

Monitor stands single	£11.50
Monitor stands double plynth Metal	£21.00

BBC BOOKS

BBC B Compendium	£5.95
Advanced Disk User Guide	£14.95
Advanced Basic Rom User Guide	£9.95
The Epson FX Kaga Printer Commands Revealed	£5.95
BBC Micro Disk Drives Complete Disk Manual	£6.95
The BBC Micro Rom Book	£7.95
The Super User's BBC Micro Book	£9.95

GXR B+	£29.00
View 3.0	£85.00
Hi-View	£55.00
View Store	£52.00
LISP ROM	£49.00
BASIC Editor	£28.00
Terminator	£31.95
Microprolog	£69.95

COMCONCEPT

Wordwise	£36.00
Wordwise Plus	£46.00
Intersheet	£55.00
Disk Doctor	£27.00
Printmaster (Epson)	£27.00
Printmaster (Star)	£27.00
Caretaker	£27.00
Graphics ROM	£59.00
Communicator	£55.00
Accelerator	£27.00
Gremlin Debug ROM	£33.00
Interchart	£30.00
Speech ROM	£10.00
Speech Processor	£55.00
Interword	£55.00
Interbase	£55.00

BEEBUG

Toolkit Plus	£39.00
Wordwise	£29.00
ICOM Master	£34.00
Studio Eight	£22.00
ROMIT	£34.00
Exmom II	£28.00
Spellcheck II	£29.00
Spellcheck Wordwise	£29.00
Spellcheck View	£29.00

CLARES

Frontwise Plus	£19.00
BROM+	£34.00
BROM	£32.00
Wordwise	£27.00
ALTRA	£42.00
Enigma Disk Imager	£42.00
Tube Editor	£34.00
Probe I	£34.00
Basic Editor 2	£25.00
Basic Editor I	£19.00
First Aid II	£19.00

GEMINI

Datagem Database	£79.00
------------------	--------

GAMES DISK

All the latest games in stock
Call for details!!!

Services

Many components now in stock. Call for details and price.

SERVICES

Fast Repair Service for the BBC Computer	
average charge from Printer repairs from	£23.00
Disk Drive repairs from	£20.00
Disk Drive repairs from	£15.00

BBC COMPUTER SPARE PARTS AND COMPONENTS

PSU	£59.00
Keypadswitch	£2.00
Complete Keyboard	£59.00
Keyboard Connector	£5.18
UHF Modulator	£5.18
Video ULA	£20.00
Serial ULA	£16.00
6522 VIA	£4.10
6502 2 MHZ CPU	£7.50
UPD 7002	£17.25
6845SP CRT CON	£7.50
SAAS 550 Teletext	£10.35
LM 324	£0.50
6522A 2 MHZ VIA	£6.33
8271	£52.00
74 LS 123	£0.46
74 LS00	£0.28
74 LS04	£0.28
74 LS10	£0.28
7438	£0.46
74 LS 163	£0.86
74 LS 244	£0.92
74 LS 245	£1.27
74 LS 375	£1.04

HOME, EDUCATION & BUSINESS NEEDS!

How to Order

You can purchase any of the items listed. All you have to do is write your requirements on a sheet of paper, and we will despatch your goods within 24 hours, subject to availability. Please add the following amounts for Postage and Packing.

Items below £10.00 add £1.50

Items below £50.00 add £2.50

Items below £100.00 add £3.50

Items over £100.00 add £8.00

(UK Mainland only)

All prices include VAT at 15%

No Hidden Extras

Please make cheques payable to:

TWILLSTAR COMPUTERS LTD.

Access/Visa Card Holders:

Welcome. Call now on:-

01-571 5938 or 574 5271



CREDIT FACILITIES

Full credit facilities now

available nationwide

* LOW DEPOSITS

* FAST FRIENDLY SERVICE

* UP TO 3 YEARS TO PAY

Call for further details

Typical APR 36.3%

SHEET FEEDER

Juki 6100	£173.00
Juki 6300	£173.00
Quendata DWP 1120	£165.00
Brother HR 15	£212.00
LX80	£55.00

RIBBONS

Full selection of Ribbons available. Call for latest prices & availability.

FONT AID

NLO Designer for Canon and Taxan KAGA NLO Printers. Design your own NLO Fonts or download one of our 20+ predefined fonts. The Fontaid Disk includes the following type styles:- Square, Outline, Gothic, Bold, Computer Type, Bold Shadow, and Broadway. Additional Disk 'A' includes:- Greek/Matus Script, P.S., Plain Handwriting, and 2 styles of Elite, Condensed, & Super Condensed. Fontaid requires 6264 RAM CHIP in printer.

Fontaid BBC	£30.00
Fontaid additional Disk	£15.00
ROMS of individual fonts	£18.00

Accessories

Raven Discs Double Sided, Double Density 96 TPI uses 3M media. Guaranteed for life. Free library Box included

EPROMS	£17.00
2764	
27128	£2.20
RAMS	£3.95
6264 LP 15	
EPROM Extractor	£3.95
EPROM Eraser	£5.00
Soft Life EPROM Blower	£32.00
	£75.00

View BBC	£10.00
View Store	£10.00
Viewsheet Electronic S/Sheet	£10.00
BBC	£10.00
Wordwise Plus	9.95

AMX MOUSE & SOFTWARE

AMX Mouse with Super Art ROM	£79.00
AMX Pagemaker	£49.95
AMX 3D Zicon	£24.95
AMX Database	£24.95
AMX XAM	£24.95
The Original AMX art Plus Utilities	£14.95
AMX Paintpot	£14.95
AMX Desk	£24.95

SYSTEM SOFTWARE

THE MUSIC SYSTEM	
Disk Pack	£29.95
Cassette 1	£14.95
Cassette 2	£14.95

EXPANSION BOARDS

Computer Concepts Sideways Board	£45.00
----------------------------------	--------

RAMAMP

RA20 +44	£79.00
RA32N	£59.00
RA32+	£58.00
ROM6S	£32.00
RAM16	£32.00
WPK for all above	£5.00

BBC Firmware

FIRMWARE	
Acorn View Word Processor	£52.00
Acorn View Sheet	£52.00
Acorn Logo ROM	£65.00
Acorn ISO Pascal	£65.00
Acorn BCPL	£99.00
GXR	£29.00

LBO Life & Business Organiser

£19.50

PACE

Commstar	£33.00
System ADE ROM	£60.00
System SPY ROM	£30.00
Edward User Pack	£44.00
Edward Teacher Pack	£25.00
BBC UltraCalc II	£79.00

VINE

Replay ROM	£34.00
TD ROM	£18.00

Disc Utilities

View Index	£14.90
View Printer Driver Generator	£10.90
Hi View	£55.20
Acorn Soft Database	£14.25
Clares Database	£21.85
Clares Graphdisc	£12.30
Clares Replica III Disk	£13.95
Clares the Key Disk	£12.30
Betabase Utilities	£11.00
Beta Accounts Profile	£21.95
Micro Text Disk	£11.00
Beebugsoft Design	£55.20
Beebugsoft Masterfile II	£18.00
Beebugsoft Teletext Disk	£18.00
Beebugsoft Sprites Disk	£10.90
Beebugsoft Disk Master	£18.00
Beebugsoft Board Disk	£18.00
Beebug Quickcalc Disk	£14.25
Beebug 'Hershey' Font	£14.25
Beebug Paintbox II Disk	£12.30
Gemini DDD Base	£29.00
Gemini DDD Calc	£29.00
Gemini DDD Plot	£29.00
Office Mate	£12.00
Office Master	£25.00
Fleet Street Editor	£39.95

TWILLSTAR COMPUTERS LTD

**APEX HOUSE, BLANDFORD ROAD,
NORWOOD GREEN, SOUTHALL,
MIDDX UB2 4HD**

Tel: 01-574 5271 01-571 5938

Telex: 25247 Telex G. attn TIL

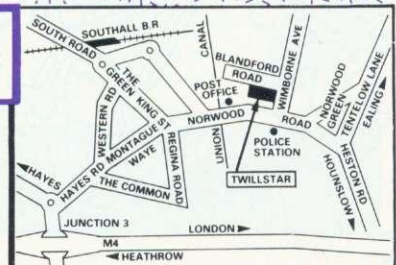

CYGNET ELECTRONICS

RAMWISE II

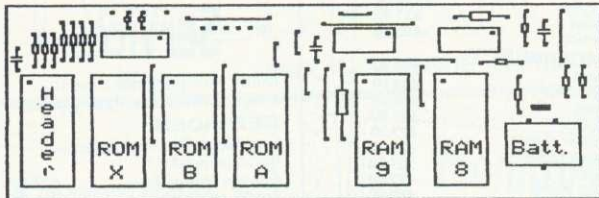

32K RAM/ROM Board

Only 38.95 inc.

Expand the capacity of your BBC micro to 32K of Sideways RAM. Plus TWO EXTRA ROM sockets. This provides a total of 8 Sideways ROMs, 6 ROM sockets + 2 banks of 16K Sideways RAM.

- *Battery backup fitted
- *Write protect switch included
- *No soldering required
- *FREE utilities disk to save and load ROMS
- *LOAD capability
- *RUNS all existing ROMS

RAMWISE 16K RAM Module

STILL AVAILABLE AT A NEW LOW PRICE OF

21.50 inc.

- *Small module plugs directly into any spare ROM socket
- *Write protect switch included
- *Runs all existing ROMS
- *Already used in schools on ECONET and E-NET systems
- *ATPL ROM board compatible

APPLY FOR QUANTITY DISCOUNTS

Post to : Cygnat Electronics, PO Box 27
Bordon, Hants. GU35 0HH
Tel : (04203) 5229

AA271

"THE PICK OF THE BUNCH" 16K SIDWAYS RAM

- * Module uses low power CMOS RAM
- * Internal decoupling capacitor for ultra-reliable data storage
- * Write protect switch now supplied for trouble free operation
- * Software provides full ROM load/save facilities
- * Formats programs for the ROM Filing System
- * RAM can be configured as a 15.5K printer buffer
- * Excellent documentation
- * A machine code patch allows Assembly language programmers to use the 65C02 instructions

Price : 16K RAM £24.85
Please specify 40 or 80 track disc when ordering. Educational discount given.

As an independent review put it . . .

"IFEL's manual is a pleasure to use . . . a massive 20 page booklet that goes into memory addressing, the sideways ROM system, as well as describe the software itself."
"The model with the most features at a reasonable price, and therefore the pick of the bunch, has to be IFEL's."

Beebug May 1986

Send cash with order/official order, or write for further details to :

IFEL, Dept. (AU)
36 Upland Drive, Derriford, Plymouth PL6 6BD
Telephone (0752) 787058



The first complete software development package

PROPAK

Multi-window text editor, assembler, loader, monitor/debugger and EPROM programmer.

- | | | |
|-------------------------------------|--|---------------|
| PROEDIT text editor | Up to nine windows anywhere on screen | |
| | Full screen editing | |
| PROASM assembler | Supports all 6502 instructions | Fast assembly |
| | Range of assembler directives | Symbol table |
| PROLOAD object module loader | Virtual & absolute loading | |
| | Full display of load addresses | |
| PROMON machine code monitor | Load and execute machine code programs | Trace feature |
| | | Hunt facility |
| PROROME PROM programmer | Burns 16k, 32k, 64k and 128k EPROMs | |
| | Fetch-to-read, burn or dump any area of RAM/ROM (Incl sideways ROMs) | |

THE MICRO USER Review July '86 **Verdict :**
"A STRIKING PIECE OF INTEGRATED SOFTWARE"

Previously affordable only by
Major Software Developers . . .

NOW ONLY £65.95

OPTIONAL EXTRAS:

The PROPAK EPROM programmer £65

PROEDIT, PROASM & PROMON ON EPROM AT £5.00 EACH

☎ 0206 579413 - TO ORDER

SCICOM INTERNATIONAL, SUITE 4,
COWDRAY CENTRE HOUSE, COLCHESTER, ESSEX CO1 1BH
ADD 15% V.A.T. TO ALL PRICES. P&P INCLUDED

AL SOFT-TEACH EDUCATIONAL SOFT-TEACH EDUCATIONAL SO FT-TEACH EDUCATIONAL SO

SOFT-TEACH EDUCATIONAL

FT-TEACH EDUCATIONAL SOFT-TEACH E

"High degree of pupil involvement" . . . "for home and class" . . . "most attractive package for a long time".

Acorn User

"The quality of the graphics is excellent" . . . "good value for money".

Teaching Geography

GENERAL MAP READING — £23 inc. VAT
COASTAL MAP READING — £23 inc. VAT
(BBC B disc only)

Soft-Teach Educational.

Orders or Details from:
Soft-Teach Educational, Sturgess, Longbridge Deverill,
Warminster, Wilts BA12 7EA.

DUATIONAL SOFT-TEACH EDUCATIONAL SOFT-TEACH

TWILLSTAR COMPUTERS LTD

TO BIGGER PREMISES

We are now trading from
APEX HOUSE, BLANDFORD ROAD
NORWOOD GREEN, SOUTHALL
MIDDUXUB24HD Tel: 01-574 5271
01-571 5938

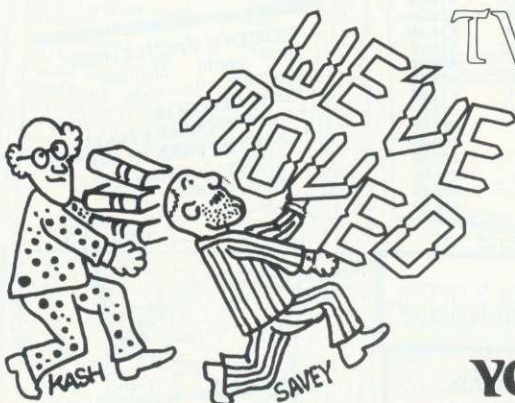

YOUR ONE STOP MEGA-COMPUSTORE
FOR YOUR HOME, EDUCATION & BUSINESS NEEDS!

STARCAD

A PRECISION TECHNICAL DRAUGHTING PACKAGE FOR THE BBC MICRO

- Features include:
- * Scaled drawing construction. 1/10mm units
 - * 'In-Zoom' or 'Out-Zoom'
 - * On screen menus. Helpful command prompts
 - * Highest resolution MODE 0 throughout
 - * User Definable Grid sizes
 - * Rubberband, Drag, Copy, Rotate, Mirror, Enlarge
 - * Reposition or erase any part of a drawing
 - * 2 or 3 point arc/circles + centre generation
 - * Cursor 'Snap' to any part of current layer
 - * Intersection and Mid-points
 - * Text of any size and orientation
 - * Visual display of library and archive discs
 - * plus many more features which lack of space prevents us from listing

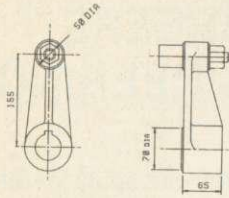

BBC Model B (OS 1.2) or B+/Master/M.Tur/6502 40/80 Track 5.25" disc drive
PLOTTERS Linear Graphics (A4M/A3M), Graphtec - Watanabe (please state model)
PRINTER Screen dump Epson compatible (included with each STARCAD program)
STARCAD Disc + Rom and Reference manual - £69 **STARDRIVE** Plotter Driver - £19

Cheques to:- **DESIGN SOFTWARE SYSTEMS**

7 Shannon Centre, Thames Estuary Industrial Estate, Canvey Island, Essex SS8 0PE

AA286

TEMPOS

SCHOOL TIMETABLING

- ☆ Suite of 11 Menu driven programmes
- ☆ Error trapped keyboard inputs
- ☆ Prompts in plain English
- ☆ Sets up data base of Teachers, Subjects and Rooms
- ☆ User controlled degrees of interactive timetabling
- ☆ Rapid modification to cover for absent Teachers
- ☆ Prints out tables of teaching resources
- ☆ Gives timetables classified by Class, Teacher or Room
- ☆ Uses BBC with Torch Z80 Diskpack
- ☆ 28 page User Guide

£65.00

DETAILS: TEMPOSI, 268 HIGH ST, BOSTON SPA
 WETHERBY LS23 6AJ, W. YORKS

CAREY ELECTRONICS

computing and communications

For "The BBC MICRO" & "MASTER SERIES"
 Computers - Peripherals - Software

Whatever your requirements:-
 WORD-PROCESSOR SPREADSHEET ACCOUNTS DATABASE
 STOCK-CONTROL COMMUNICATIONS C.A.D. SYSTEMS
 From a 13 Amp plug to a complete Microcomputer System, we are
 able to supply suitable equipment from the following manufacturers:-
ACORN AMSTRAD APRICOT ROBOCOM SANYO TORCH

★★THE ACORN BBC "MASTER SERIES" IN STOCK★★

To expand or improve your existing system we can supply:-
MONITORS PRINTERS PRINTER-BUFFERS PLOTTERS MODEMS DISKDRIVES

SUMMER SOFTWARE SALE

£4 OFF THE FOLLOWING PUBLISHED PRICES
 While stocks last. First come first served

BEEBUGSOFT:	ACORN SOFTWARE:	COMPUTER CONCEPTS:
(ROMs)	(ROMs)	
Dumpmaster II 31.00	View 59.80	Accelerator 64.40
Exmon II 32.00	Viewsheet 59.80	Caretaker 33.35
Help II 31.00	Viewstore 59.80	Communicator 69.00
Icon Master 34.00	CHALICE:	Disc Doctor 33.35
Murom 32.00	(ROMs)	Graphics ROM 33.35
Romit 32.00	The Scythe 24.00	Inter-Chart 36.80
Sleuth 32.00	ROM Master 16.00	Inter-Sheet 56.35
Spellcheck III 36.00	CLARES: (ROM)	Speech 33.35
Toolkit Plus 39.00	Brom 34.50	Termi II 33.35
Wordease 29.00	GEMINI: (ROMs)	Wordwise 46.00
A.C.P. "ADT ROM" 34.50	Data Gem 79.95	Wordwise Plus 56.35
	L.B.O. 19.95	

It's AFTER the SALE, that SERVICE counts!!

PRICES INCLUDE V.A.T. @ 15%
 PLEASE ADD 75p POST & PACKING

7 Church Road, WALTON-ON-NAZE, Essex CO14 8DF.
 Tel: Frinton-on-Sea (02556) 6993. (9am to 9pm)
Acorn, Amstrad, Apricot, Prestel, Robocom, Sanyo, and Torch
 are all Registered Trade Marks.

AA254

create programs
 ten times...

Faster



"System Delta is an exciting development in Database software for the BBC micro. It provides the kind of incentive to program your own applications which dBaseII did when it first appeared for the CP/M systems." (Personal Computer World)

Imagine, 150 commands instantly at your disposal to enable you to create and write programs in a fraction of the time it would normally take, and they can be fully RELATIONAL with up to FIVE FILES open at any one time. Well, it's a reality!

System Delta is the first programmable Database Management System written for the BBC. Written in machine-code as an extension to the BBC BASIC it provides for file handling, finding records, screen design, data handling and even menu selectors. You will be amazed at its power and flexibility—even graphics may be produced from files holding thousands of records. System Delta allows you to write professional WYNIWYG (what you NEED is what you get) programs.

"...a whole new world of specialisation looms on the horizon" Prestel
 "It's no longer on the horizon—look here and see our first release of applications!" Minerva Systems

REFERENCE GUIDE
 To take full advantage of System Delta this Reference Guide contains full details of all commands, example usage, technical points as well as the overall concepts of the system. Fully explained Job Costing example.
 "Although the manual is highly detailed because of the nature of Delta it is quite precise and very straight forward." (Tublink)
 £19.95

VIDEO RENTAL
 Simultaneously handles over 8000 videos & 5000 customers (using ADPSL). Produces receipts including fines for overdue returns, membership fees, extended bookings, etc. Daily takings, Top Ten, Fast search. Extensive reports & analysis by revenue, certificate, late hire, overdue, Price Lists. Generate letters to categories of customers.
 £54.95

ORDER PROC/INVOICING
 Cash & Credit customers with archives for details. Definable invoice layout. Free or Fixed format. VAT codes with analysis. Discounts by %, £ or a structure depending on customer type and products purchased. Pre-invoiced orders editable. Orders/Invoices may be batch printed. Updates Sales Ledger, if linked.
 £45.95

PRINTERS ANGEL
 Define your own character fonts for popular NLQ printers. Fast machine-code screen handling. Banner mode for designing multiple character definitions. Slant/unslant for easy italics. Create parts of fonts for merging character sets. Definable 'fig of 8' grid for design consistency. 5 popular typestyles provided.
 £27.95

ALL APPLICATIONS £64.95
 NEED THE SYSTEM DELTA ROM

HOTELIER
 80 rooms with full descriptions for matching to guests' requirements. 4000 advanced bookings including full guest details. Archive facility for mailshots to past guests. Bills produced for guests. Standard letters for booking confirmations, etc. Arrival/Departure sheets produced.
 £59.95

ESTATE AGENT
 Retains Client & Property details for that perfect match. Secondary scan to detect 'near matches'. Remembers which details were sent to which client so reducing overheads. Scans for properties or clients not recently referenced to allow special attention. Financial enquiry for mortgage estimates, etc. according to financial status. t.b.a.



SALES LEDGER
 Full maintenance of transaction files for payments, adjustments, invoices and month and statements. Extensive reporting facilities include Daybook Reports, Analysis, Aged Debtor and monthly Control report. Access by name or number of Account. Updated by invoicing, if linked.
 £45.95

DATABASE FREE

Written using System Delta this simple to use, powerful database has total flexibility as well as speed. It can find any unique record in typically 3 seconds! It can handle 8160 cards, 255 fields, 200 characters per field. Records may be printed in any format and searches may be performed to multiple criteria, and placed in one of the 8 subsets available. Extensive maths calculations may be carried out. Sort. Card copier for easy transfer between files. This is what the press say...
 "This database ranks with the best providing every facility ever likely to be needed. Most other software houses would be advertising it as the all singing all dancing database." (Micro User)
 "Exceptionally simple. I have little doubt that the time taken to design the application will be less than virtually any other database I know. In short the person who finds this package will find a problem should not be using the BBC micro." (Micro User)
 "Anyone looking for a good, easy to use database as it is a fast and versatile program in its own right. Many people will buy System Delta for the Card Index alone." (Personal Computer World)
 "I must unreservedly recommend this product." (Micro User)
 "The great innovation with Delta is its flexibility unlike dedicated databases it allows practically unlimited scope for modification." (Tublink)

This Database is supplied FREE when purchasing System Delta.

SCHOOL ADMINISTRATOR
 Pupil records handled quickly and efficiently. Breakdown/analysis for class lists. Examination Lists including National Examination entry forms for GCE, CSE, etc. (upwards compatible for the new GCSE). Includes class transfer utility to move pupils at the year end.
 On applic.

MAILSHOT
 Use with data from any System Delta application for Address labels, Video labels, etc. Design layouts or use one provided. Up to 4 across, selectable spacing, margins, blank line removal, printer control codes. Word processor link with Wordwise+ and View for personalised letters. Output entire file, range or group. Calculations. WW+ segment.
 £19.95

Compatible with just about everything including: BBC Master, ADPS, Watford, Midwich, Challenger 3, etc.
THIRD PARTY SOFTWARE HOUSES
 Contact us for Licensing details for your applications
DEALERS
 Contact us for Dealer terms and Amstrad range.
CUSTOMISATION / TRAINING
 Customisation or individual systems written. Training available.

MINERVA SYSTEMS
 69 SIDWELL ST, EXETER, DEVON
 EX4 6PH TEL. 0392 37756

EPROM PROGRAMMER

for the BBC micro

An exceptionally versatile unit, programs EEPROMs and EPROMs from 2K to 32K.

Powerful, easy to use software in a sideways ROM.

Features full screen data editor, files, and softkeys.

Professionally designed hardware ensures reliable and safe programming, also detects badly socketed EPROMs.

Soundly constructed in a convenient flip-top box which protects unit when not in use.

Supplied with a comprehensive manual.

Adaptors for single chip EPROM MPU's available.

£95 (excl VAT, free P&P)

10% Educational discount available

2 year guarantee. Detailed information on request



Now with new software

- ★ Handles the latest EPROMs
- ★ Faster operation
- ★ Checksums



Control Telemetry of London
Unit 11, Burmarsh, Marsden St.,
London NW5 3JA Tel: 01-482 2177

"TITLE YOUR VIDEOS WITH THE BBC"

A full titling programme, originally written to title our own video productions, is now available for all BBC-B owners. It's features include 4 large fonts including Old English (ideal for weddings), proportional spacing, under and overlining, drop-shadow and use of all 16 colours in Modes 1 and 2. Easy to use with full instructions, plus advice on other aspects of BBC-B titling. Disc only. Please state 40 or 80 track. Send £15.75 to Coastal Tape Ltd, PO Box 135, London N20 0HF.

AA212

CAMBRIDGESHIRE COLLEGE OF ARTS AND TECHNOLOGY

COURSES FOR CAREERS BTEC HND IN ENGINEERING (SOFTWARE)

With ONE 'A' level in ANY subject you can apply for the course that guarantees excellent career prospects. Designed in collaboration with leading high technology companies to provide the training in real-time systems that industry is asking for, including: software specification, design and testing for real-time systems, operating systems, data communications and project management.

BTEC HND IN ELECTRONIC ENGINEERING

Specialising in microelectronics, microprocessors, computing and information technology. Entry requirements are 'A' level Maths or Physics, with the other also studied to 'A' level.

For further information contact:

The Secretary,
Department of Engineering, CCAT,
East Road, Cambridge CB1 1PT
Telephone (0223) 352973

AA269

BBC/ELECTRON 'IMAGE' V.2 'IMAGE' was the ultimate tape back-up copier now, it's even better

You can be completely assured that this is the best and most able program of its type available. It can deal with:

- * Locked programs
- * Programs of any length
- * 300t and 1200 BAUD
- * Files
- * ?'s (Ctrl codes) in Filename
- * Multiple copies
- * False or trick block info.
- * Changing Filename†
- * Continuous data stream†
- * Locking and unlocking programs

It is VERY IMPORTANT INDEED purchasers take note that 'IMAGE' is for sale strictly for making BACK-UPS of your own software for your own use, for protecting your own programs, or as an aid to putting software on disk. Any person found using the program for illegal purposes runs the risk of being prosecuted.

To receive your copy of 'image', send a cheque or P.O. for the sum of
An Astounding £5.80 to:

**Peter Donn, Dept. (AU) 18 Tyrone Road,
Thorpe Bay, Essex SS1 3HF**

Please state BBC or Electron version. V.1 owners can obtain V.2. by sending £1.50 + V.1 without case TBBC version only

AA296

without case

TBBC version only

TWILLSTAR COMPUTERS LTD

**YOUR ONE STOP
MEGA-COMPUSTORE
FOR YOUR HOME, EDUCATION
& BUSINESS NEEDS!**

From 1st Sept. Open 7 Days Aweek

Apex House, Blandford Road, Norwood Green, Southall, Middx. UB2 4HD

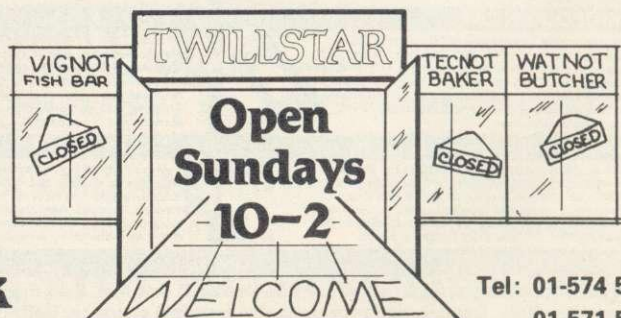

Tel: 01-574 5271
01-571 5938

Telex: 25247 attn TIL

LOW COST C.A.D.

ATTENTION ALL ELECTRONICS CIRCUIT DESIGNERS!!
"IBM PC (and compatibles), BBC MODEL B, B+ and MASTER, AMSTRAD CPC and SPECTRUM 48K"

ANALYSER I and II compute the A.C. FREQUENCY RESPONSE of linear (analogue) circuits. GAIN and PHASE, INPUT IMPEDANCE, OUTPUT IMPEDANCE, and GROUP DELAY (except Spectrum version) are calculated over any frequency range required. The programs are in use regularly for frequencies between 0.1Hz to 1.2GHz. The effects on performance of MODIFICATIONS to circuit and component values can be speedily evaluated. Circuits containing any combinations of RESISTORS, CAPACITORS, INDUCTORS, TRANSFORMERS, BIPOLAR AND FIELD EFFECT TRANSISTORS and OPERATIONAL AMPLIFIERS can be simulated - up to 60 nodes and 180 components (IBM version). Ideal for the analysis of ACTIVE and PASSIVE FILTER CIRCUITS, AUDIO AMPLIFIERS, LOUDSPEAKER CROSS-OVER NETWORKS, WIDE-BAND AMPLIFIERS, TUNED R.F. AMPLIFIERS, AERIAL MATCHING NETWORKS, TV I.F. and CHROMA FILTER CIRCUITS, LINEAR INTEGRATED CIRCUITS etc. STABILITY CRITERIA AND OSCILLATOR CIRCUITS can be evaluated by "breaking the loop". Tabular output on Analyser I. Full graphical output, increased circuit size and active component library facilities on Analyser II. Check out your new designs in minutes rather than days. "ANALYSER" can greatly reduce or even eliminate the need to breadboard new designs. Used by INDUSTRIAL, GOVERNMENT and UNIVERSITY R&D DEPARTMENTS worldwide. IDEAL FOR TRAINING COURSES. VERY EASY TO USE. Prices from £20-£195.

LOW COST COMPUTER DRAUGHTING ON THE BBC MODEL B, B+

DRAWER I enables quality drawings to be created, and modified, quickly, easily and with the minimum of hardware. All of the major program elements are written in machine code giving exceptional speed of operation.

FEATURES

Rubber Banding for drawing lines. Solid or Dotted line types. Circles, Arcs and partial or complete Ellipses. Vertical or Horizontal Text. Pan and Zoom. Merging of drawings and library symbols from disc. Up to 20,000 lines on a drawing. Snap to a user defined grid. Absolute or Relative cursor co-ordinates displayed on screen. Input from analogue joystick, mouse or trackball. Output to standard dot matrix printer. Prices from £45 - ex VAT. Minimum Hardware Required: BBC Model B. Single or Dual 5.25" Disc Drive - 40 or 80 track. TV or monitor. Games Joystick, Mouse or Trackball. Dot Matrix Printer (Epson 80 series or Epson compatible - BBC default mode).

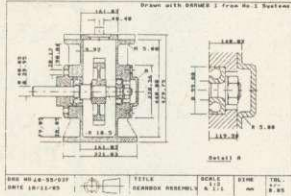

Full AFTER SALES SERVICE with TELEPHONE QUERY HOTLINE and FREE update service

For illustrated leaflets and ordering information please write or phone:
NUMBER ONE SYSTEMS LIMITED TEL: 0480 61778
 Ref: AU TELEX: 32339
 Crown Street,
 St Ives Huntingdon, Cambs PE17 4EB

AA181A

Superdraft

2-D draughting on IBM PC/BBC/TORCH.

Superdraft is not a general drawing package - it has the technical features you need to produce engineering drawings for any discipline. Here are some of Superdraft's BBC/Torch facilities:

- Simple keyboard operation, or use optional digitiser.
- Full, dash, chain and arrowed lines/arcs.
- Drawings of 38 graphics and 26 text layers, all in mode O. Layers may be individually hidden, erased, stored and moved between drawings.
- Unrestricted zoom, scale, translate, rotate and reflect commands.
- Precision movement/measurement (six significant figures) in rectangular/polar co-ordinates or preset steps.
- Automatic 'snapping' to points, lines, arcs, symbols, intersections of line-line/line-arc/arc-arc.
- Automatic drawing of parallel, perpendicular and radial lines, and tangents between point-arc/arc-arc.
- Superb automatic dimensioning to ISO standards. This feature is superior to any on the BBC, and must be seen to be appreciated.
- Text at any angle and size.
- Automatic cross-hatching, any pitch and line type.
- Automatic arc blending (fillet arcs), with selectable radius, at intersections of line-line/line-arc/arc-arc.
- Predefined and user-defined symbol libraries. Symbols may be scaled and rotated or automatically fitted (even at an angle).
- Output to colour plotter with automatic scaling to paper size if required. Pen colours/thicknesses individually selectable.
- Calculation of area, perimeter, moments, centre of gravity and principal axes of a section.

Superdraft runs on BBC with Z80 second processor, and Torch computers. We can supply complete systems, including hard-disc and network.

Superdraft is in use now in industry, training and education. It can handle the technical drawings that other systems can't - try us!

IBM: Superdraft also runs on the IBM PC (and compatibles) with many more facilities making Superdraft a world leader in low-cost CAD.

Special discounts for education means lower than ever prices for training establishments, higher education and schools.

We believe a demonstration will convince you of Superdraft's abilities - ring us now to arrange one. Demonstration discs also available.

peak
SYSTEMS DESIGN LTD.

U.K. House, Station Road, Ecclesfield, Sheffield S30 3YR. Tel: (0742) 455433

B+S COMPUTING (NOTT'M) LTD

55 CEDAR AVE, LONG EATON
 NOTTINGHAM ☆ NG10 3JQ

BUSINESS SYSTEMS ☆ HARDWARE ☆ SOFTWARE VIDEO SYSTEMS ☆ MEDIA SUPPLIES

Callers welcome to our Distribution Centre. Please phone for appointment.

Telephone: 0602-736273

Acorn Products

BBC Master 128	£404(a)
BBC Master ET (Econet filing system only)	£328(a)
Turbo Upgrade	£102(c)
Turbo 512 Upgrade	POA
SC Upgrade	POA
Master Eprom Cartridge	£13(e)
64K Upgrade kit for B+ 64K	£29(d)
280 Second processor	£324(a)
6502 Second processor	£164(a)
1770 Disc Interface	£40(e)
ADFS ROM (BBC B+ or BBC B with 1770 Interface)	£25(e)
Games Paddles	£16(d)

Dot Matrix Printers

Kaga KP810 80col/150cps + 27cps NLO	£219(a)
Mannesmann Tally MT80 + 80col/100cps	£161(a)
Mannesmann Tally MT85 80col/180cps + 45cps NLO	£299(a)
Mannesmann Tally MT86 136col/180cps + 45cps NLO	£399(a)
Epson LX80 80col/100cps + 22cps NLO	£189(a)
Epson FX85 80col/180cps + 32cps NLO	£329(a)
Epson LQ800 80col/200cps + 67cps NLO	£494(a)
Juki 5510 80col/180cps 30cps NLO	£229(a)

Plotters

Epson H180 A4	£329(a)
---------------------	---------

★★Special Printer Offers★★

Juki 6100 (Daisywheel) 20cps	£252(a)
MP Daisy Junior (Daisy wheel) 14cps	£149(a)
Canon PW1080A (Dot Matrix) 80col/150cps + 27cps NLO	£244(a)
Citizen 120D 80col/120cps + 25 cps NLO	£150(a)

☆ All Citizen Printers have a two-year warranty ☆

Printer Accessories

Epson 8143 Serial Xon/Xoff + OK Buffer	£26(d)
Epson 8148 Serial Xon/Xoff + 2K Buffer	£55(d)
Mannesmann Tally MT80 + RS232C + OK Buffer	£39(d)
Epson LX80 Ribbon (Compatible)	£2.89(e)
Epson 8302 LX80 Tractor Unit	£19(c)
Epson 8338 Single Sheet Feeder	£49(b)
Epson MX/80/FX80/FX85 Ribbon (Compatible)	£2.24(e)
Mannesmann Tally MT85/MB8 Font Cartridge	£17(e)
Centronics Parallel Printer Lead (1.5m)	£7.50(e)

☆ Comprehensive range of Accessories supplied ☆

Monitors

Philips BM7502 High res mono green + sound	£69(a)
Philips BM7522 High res mono amber + sound	£74(a)
Philips CM8501 STD res colour RGB + sound	£174(a)
Philips CM8533 Med res colour RGB + composite video + sound (Green screen switchable)	£239(a)
Philips CF1114 TV/RGB monitor	£169(a)
Microvitec 1431MS STD res colour RGB	£179(a)
Microvitec 1451MS Med res colour RGB	£224(a)
Microvitec 1441MS High colour res RGB	£375(a)

☆ All monitors are supplied with a free BBC lead ☆

Disc Drives

Opus single SS 40T 100K	£73(a)
Opus single DS 40/80T 400K	£112(a)
Opus single DS 40/80T 400K + PSU (dual case)	£132(a)
Opus dual DS 40/80T 800K PSU	£249(a)
Opus Challenger 3:256K Ram disc	£165(a)
Opus Challenger 3:512K Ram disc (2 x 256K)	£200(a)
UFD Dual DS 40/80T 800K + PSU On Master Plinth	£244(a)

Discs

3M 744 SS/DD 48TPI 5.25" (Box of 10)	£11(d)
3M 745 DS/DD 48TPI 5.25" (Box of 10)	£13(d)
3M 747 DS/DD 96TPI 5.25" (Box of 10)	£17(d)
3M 35SS SS/DD 3.5" (Box of 10)	£23(d)
3M 35DS DS/DD 3.5" (Box of 10)	£33(d)
Floppicleene Head Cleaning Kit (20 Discs)	£15(d)

Library Cases £1.50(e) or £1.00 if purchased with discs

Fanfold Paper and Labels

2000 x 1 part 60gm 11" x 9.5" STD perf	£10(c)
1000 x 1 part 85gm 11" x 9.5" Micro perf	£9(c)
2000 x 1 part 60gm 11" x 15" STD perf	£15(b)
1000 x 1 part 90gm Perfect A4 Micro perf	£12(c)
1000 x 2 part NCR 60gm 11" x 9.5" STD perf	£17(b)
1000 Labels 90mm x 36mm	£4(d)
1000 Labels 90mm x 49mm	£6(d)
1000 Labels 102mm x 36mm	£5(d)

Please state single or twin row when ordering labels

AMX Mouse And Software

AMX Mouse And Super Art	£65(d)
AMX Pagemaker (For BBC B or BBC B+)	£37(d)
AMX Pagemaker (For BBC Master Series)	£37(d)

Modems

Miracle WS2000 + BBC Lead	£100(c)
Miracle WS2000 Auto Dial Board	£28(d)
Miracle WS2000 Auto Answer Board	£28(d)
Miracle Databeeb Communications ROM	£24(e)
Miracle WS3000 V2123 + BBC Lead	£269(a)
Miracle WS3000 V22 + BBC Lead	£449(a)
Miracle WS3000 V22bis + BBC Lead	£599(a)
Pace Nightingale + Commstar + BBC Lead	£114(c)
Nightingale Auto Dial/Auto Answer Board	£44(d)
Nightingale Auto Dial/Auto Answer Software	£10(e)
Pace OBBS Bulletin Board Software	£19(e)

**** Please Note: BABT Approval on Modems Only ****

Languages

Micro-Prolog	£49(d)	ISO-Pascal	£42(d)
BCPL £37(c)	Forth £32(e)	Comal £32(e)	Lisp £32(e)

Business Software

View 2.1	£37(d)	View Sheet	£37(d)
View 3.0	£57(d)	View Store	£37(d)
View Spell	£37(d)	View Plot	P.O.A.
Hi-View	£37(d)	View Index	£10(e)
View Printer Driver Generator	£7(e)	Disc	£8(e)
Inter-sheet	£39(d)	Inter-chart	£26(d)
Inter-word	£39(d)	Inter-base	£41(d)
Wordwise	£30(d)	Wordwise Plus	£41(d)
Fleet Street Editor (Please State 40T or 80T)	£31(d)		

Books (No VAT on Books)

Master Reference Manual: Part 1 £14(d)	Part 2 £14(d)
Advanced Master Reference Manual	£19(d)
ISO Pascal	£6.50(e)
View Guide	£4.50(e)
View 3	£9(e)
Lisp	£6.50(e)

☆ Large Range supplied - phone for details. ☆

Rom Boards

ATPL 'Sidewise'	£36(d)
Computer Village CV16 x 2	£37(d)

UK Customers: please add 15% VAT to all prices (including carriage). Government and educational establishments official orders welcomed. When ordering please enclose a cheque or postal order for the appropriate amount. Carriage Rates: (a) £3.50 - overnight insured delivery (b) £3.50 (c) £2.50 (d) £1.50 (e) £1.00. All prices are correct at time of going to press. All offers are subject to availability. All prices are subject to change without prior notification and are available on request. Current price list is available on request.

AA279

LEADING SUPPLIER TO THE BBC MARKET ESTABLISHED OVER 15 YEARS

TECHNOMATIC

17 Burnley Road, London NW10 1ED Tel: 01-208 1177
305 Edgware Road, London W2 Tel: 01-723 0233

BBC MASTER SERIES

AMB15 MASTER Foundation 128K.	£395 (a)
AMB12 MASTER ET (ANFS only)128K	£319 (a)
AMCO6 Turbo 65C02 Module	£105 (b)
ADC08 512 Processor	£345 (b)
ADF13 ROM Cartridge	£13 (d)
ADF10 Econet Module	£43 (c)
ADJ22 Ref Manual Part I	£14.95 (c)
BBC MASTER Dust Cover	£4.75 (d)
ADJ23 Ref Manual Part II	£14.95 (c)
ADJ24 Adv Ref Manual	£19.50 (c)
View User Guide	£10 (d)

UPGRADE KITS

1.2 OS ROM	£15 (d)	8271 DFS Kit	£80 (d)
DNFS ROM	£17.50 (d)	1770 DFS Kit	£43.50 (d)
BASIC II ROM	£22.50 (d)	Econet Kit	£55 (d)
ADFS ROM	£26 (d)	64K Upgrade Kit for B+	£35 (d)

ECONET ACCESSORIES

Econet Starter Kit	£85 (b)	Econet Bridge	£174 (b)
Econet Socket Set	£29 (c)	Printer Server Rom	£41 (d)
File Server Level II	£179 (b)	10 Station Lead Set	£26 (d)
Ad Econet User Guide	£10 (d)	Econet Manager's Guide	£10 (d)

32016 CO PROCESSOR

For full specification see page 5 **£999 (a)**

CAMBRIDGE W/STATION

For full specification see page 5 **£3,450 (a)**

WINCHESTER DRIVES

Acorn Winchesters complete with File Server Level III and ADFS hierarchical filing system. Data transfer rate of 1Mbit/sec and average seek time of 85ms providing very fast access times.

Acorn 10 Mbyte Winchester £1,075 (a)
Acorn 30 Mbyte Winchester £1,599 (a)

See Disc Drive Section for Technomatic's Winchester range.

SECOND PROCESSORS

ACORN Z80 2nd Processor £329 (a)
with 64K RAM, CP/M operating system. Comprehensive package of bundled business software.

ACORN 6502 2nd Processor £160 (b)
with second 6502 and 64K RAM provides faster data processing speeds and larger user RAM.

TORCH ZEP 100 £229 (b)
Z80 cpu with 64K RAM and TORCH's CP/M compatible MCP operating system. With FREE bundled software. Fits internally in the computer.

TORCH TZDP240 £439 (a)
Torch ZEP100 with TECHNO-MATIC's dual drive with monitor stand PD800P.

MULTIFORM Z80 £299 (b)
TECHNOMATICs multi format Z80 system. Details on page no?? includes free POCKET WORDSTAR.
MS/DOS Read/Write Utility £49 (d)

ACORN IEEE INTERFACE

Allows BBC computer to control any scientific and technical equipment that conforms to the IEEE488 standard. The interface can link upto 14 compatible devices. Typical applications are in experimental work in academic and industrial labs.

£269 (a)

TELETEXT ADAPTOR

Converts your computer into a teletext receiver.

£125 (b)

ROBOCOM BITSTICK

BITSTICK I £299 (a)

BITSTICK II £775 (a)

Upgrade for Bitstick I to II **£415 (a)**

Bitstick I Multiplotter Driver (includes most popular plotters) **£79 (c)**

Epson FX80 Dump for Bitstick 1/II **£25 (d)**

PRINTERS

EPSON LX80 £195 (a)
100 cps, Variety of fonts, quad density bit image graphics NLQ, Standard Centronics interface.

EPSON LX80 Tractor Feed £20 (c)

EPSON LX80 Sheet Feeder £49 (c)

EPSON LX86 £229 (a)
As LX80 but 120cps and IBM compatible.

EPSON FX85 £315 (a)
160cps, 80 col, 80K buffer, NLQ, IBM compatible graphics Variety of fonts, multiple density bit image mode.

EPSON FX105 £449 (a)
As FX85 but with wide carriage for 136 col

EPSON FX80 £260 (a)

EPSON LQ800 £459 (a)
See specification on page 5

EPSON LQ1000 £659 (a)
As LQ800 but wider carriage for 136 columns

TAXAN KP810 £219 (a)
140 cps, 80 col, NLQ, 2K buffer, variety of fonts, quad density hi res bit image graphics, centronics interface standard

TAXAN KP910 £369 (a)
As KP810 but with wide carriage for 156 col

BROTHER M1409 £299 (a)
180 cps, 80 col, NLQ, IBM graphics/Epson FX compatible, friction/tractor std, variety of fonts, multiple density bit image graphics, dual interface.

BROTHER M1509 £399 (a)
As M1409 but wider carriage for 136 col

EPSON JX80 colour printer £420 (a)

INTEGREX Multicolour Inkjet printer £549 (a)

CANON PJ1080A printer £409 (a)
4 Colours.

BROTHER HR15 Daisy wheel printer

14 cps, 3K buffer, proportional spacing, underline, bold, shadow print, super/sub script, two colour print, parallel interface. **£325 (a)**

JUKI 6100 Daisy wheel printer £249 (a)
15 cps, 2K buffer, switchable 10/12/15 cpi proportional spacing, underlining. Parallel interface.

PLOTTERS

See details on page 5.

EPSON HI 80 PLOTTER £325 (a)

HITACHI 672 PLOTTER £454 (a)

GRAPHICS WORKSTATION £609 (a)

LINEAR GRAPHICS PLOTMATE A4 PLOTMATE £299 (a)

A4M PLOTMATE £399 (a)

A3M PLOTMATE £549 (a)

PRINTER SHARERS & BUFFERS

BUFFALO 32K £75 (c)
32K parallel buffer for internal fitting to most EPSON/Epson compatible printers.

TECHNO SHARER BUFFER £199 (b)
A unique sharer/buffer connects upto 3 computers to a single printer with auto scan and switching to computer outputting the data. Printer PAUSE, COPY and CLEAR facility. Mains powered, two buffer sizes 64K & 256K

TSB 64 £275 (b)
TSB 256 £199 (b)

PERIPHERAL & COMPUTER SHARERS
High quality switches to allow the user to switch between computers, printers, modems etc. Fully shielded metal cases. all lines fully switched.

3 Computers to 1 Printer 36v36-3 £69 (c)

4 Computers to 1 Printer 36v36-4 £85 (c)

2 computers/2 Printers X-over 36v36-x £69 (c)

BBC Cable set 3 to 1 (1m ea) £32 (d)

BBC Cable set 4 to 1 (1m ea) £39 (d)

25v25-3 £65(c)

25v25-4 £75(c)

25v25-x £65(c)

£34(c)

£41(c)

BBC Computer Sharer: TCS26 £19.50 (c)
1 computer to 2 printers fitted with BBC cable

DISC DRIVES

Full details on page 4.

5.25" Single Drives 40/50 switchable: £103 (b)
TS400 400K/640K

PS400 400K/640K with integral mains power supply £114 (b)

5.25" Dual Drives 40/80 switchable:

TD800 800K/1280K £205 (a)

PD800 800K/1280K with integral mains power supply £229 (a)

PD800P 800K/1280K with integral mainspower supply and monitor stand £249 (a)

BBC Computer & Eonet Referral Centre

MAIL ORDER
17 Burnley Road
London NW10 1ED
Telex: 922800

RETAIL SHOPS
15 Burnley Road, London NW10 1ED
Tel: 01-208 1177 Telex: 922800
(close to Dollis Hill ☺)
West End Branch
305 Edgware Road, London W2
Tel: 01-723 0233
(near Edgware Road ☺)

For fast delivery telephone your order on 01-208 1177 using VISA/Access Card



Orders welcome from government depts & educational establishments.

All prices ex VAT. Prices are subject to change without notice.

Please add carriage
(a) £8.50 (Datapost) (b) £2.50 (c) £1.50 (d) £1.00

WINCHESTER DRIVES

P20 HD 20 Mbyte Hard Disc with ADFS Compatible **£669 (a)**

P204HP 20 Mbyte Hard Disc, 80T DS floppy in a monitor stand **£865 (a)**

P204IHT As P204HP and a 10 Mbyte tape streamer, with backup utilities **£1579 (a)**

3.5" 80T DS Drives:
TS351 single 400K/640K **£89 (b)**

PS351 single 400K/640K with integral mains power supply **£99 (b)**

TD352 Dual 800K/1280K **£155 (b)**

PD352 Dual 800K/1280K with integral mains power supply **£169 (b)**

DISC DRIVE MULTIPLEXER

Full specification on page 4.

TDM2
Dual Unit: 2 computers/one drive unit **£75 (b)**

TDM4
Quad Unit: 4 computers/one drive unit **£135 (b)**

3M FLOPPY DISCS

5.25" Discs in packs of 10
744 40T SS DD 4 **£10.50 (d)**

745 40T DS DD 3 **£12.75 (d)**

746 80T SS DD 3 **£16.50 (d)**

747 80T DS DD 3 **£16.50 (d)**

(Add £1 for library case packing)

3.5" Discs in packs of 10

80T SS DD 3 **£20 (d)**

80T DS DD 2 **£27 (d)**

The number in green is the qualifying number for a free SWISS ARMY KNIFE while stocks last.

FLOPPICLENE DRIVE HEAD CLEANING KIT

5.25" Kit with 20 disposable discs **£12.50 (d)**

3.5" Kit with 20 disposable discs **£14.00 (d)**

DISC STORAGE BOXES

DB530 Non Lockable 30 x 5.25" **£6.00 (c)**

DB340 Lockable 40 x 3.5" **£8.50 (c)**

DB550 Lockable 50 x 5.25" **£9.50 (c)**

DB570 Lockable 70 x 5.25" **£11.00 (c)**

DB5100 Lockable 100 x 5.25" **£13.00 (c)**

MONITORS

BBC lead incl with all monitors

MICROVITEC 14" RGB Monitors

Please specify plastic or metal case.

Microvitec 1431
Standard Resolution 453 pixels **£179 (a)**

Microvitec 1431AP
As 1431 + composite video and sound input **£195 (a)**

Microvitec 1451
Medium Resolution 653 pixels **£225 (a)**

Microvitec 1451AP
As 1451 + composite video and sound input **£260 (a)**

Microvitec 1441

High Resolution 895 pixels **£365 (a)**

Microvitec 20" RGB/PAL/ Audio Monitors

Microvitec 2030CS
Standard Resolution RGB/Comp Video **£380 (a)**

Microvitec 2040CS
High Resolution RGB/Comp Video **£685 (a)**

TOUCHTEC-501
Brings genuine touch screen operation on metal cased Microvitec monitors, incl utilities disc with starter and development programs **£239 (b)**

TAXAN SUPER VISION III

12" Hi Res/Hi Contrast
Option to switch to green/amber
BBC/IBM Compatible **£325 (a)**

MITSUBISHI XC1404

14" Med Res RGB Monitor
Etched dark screen brilliance and contrast control, BBC/IBM compatible **£229 (a)**

MONOCHROME MONITORS

TAXAN KX1201G
12" Hi Res green etched screen **£90 (a)**

TAXAN KX1202G
12" Hi Res Long Persistence (P39) **£98 (a)**

TAXAN KX1203A
12" Hi Res amber etched screen **£98 (a)**

PHILIPS BM 7502
12" Hi Res green screen **£75 (a)**

PHILIPS BM7522
12" Hi Res amber screen **£79 (a)**

MONITOR ACCESSORIES

Microvitec Swivel Base (14" plastic monitors) **£20 (c)**

Philips Swivel Base **£14 (c)**

Monitor Stand Models B & B+ **£10 (c)**

Monitor Stand Master **£13 (c)**

Double Tier stand Models B, B+ or Master **£24 (b)**

Taxan RGB Lead **£5 (d)**

Microvitec Lead **£3.50 (d)**

Monochrome BNC/Phono Lead **£3.50 (d)**

RAM/ROM EXPANSION

ATPL Board for Model B. Simple to instal, no soldering. Allows expansion to 15 Roms + 2 8K Rams **£37 (b)**

ATPL Battery backup kit **£18 (b)**

RAMROM 15 for Model B. External board in an attractive case — easy access to sockets. 6502 Processor signals for development work. **£79 (b)**

Low Profile Cartridge Module
Module + 1 cartridge **£12 (d)**

Spare Cartridge **£2.50 (d)**

Cartridge rack **£1.50 (d)**

TIME WARP

Real Time Clock. Plugs into the user port, battery back up as standard, includes manual, demo software including a diary/planner application program **£29 (d)**

MODEMS

(All modems are BAPT approved)
See page 7 for modem specifications

MIRACLE WS2000V21/23 & BELL stds **£79 (c)**

WS2000 Auto Dial Card **£26 (d)**

WS2000 Auto Answer Card **£26 (d)**

WS2000 SK1 Kit **£5 (d)**

WS2000 DS1 disc **£10 (d)**

WS2000 Data Cable for BBC **£6 (d)**

MIRACLE WS4000 V21/23 **£149 (b)**

MIRACLE WS3000 V22 **£495 (b)**

MIRACLE WS3000 V22 bis **£650 (b)**

BBC Data Cable for WS3000 **£7 (d)**

GEC DATACHAT Modem V23

1200/75 75/1200 & 1200/1200 pseudo f.d. line powered, complete with software suitable for connecting to Prestel, Micronet, Telecom Gold and many bbs. Special offer price **£69 (b)**

PROGRAMMING

ACCESSORIES/SOFTWARE

see page 8 for detailed specification

Compatible with B, B+ and Master

EPROMER II with disc based software and rom image **£99 (b)**

META ASSEMBLER **£145 (b)**

PORTAL EPROM EMULATOR 256K **£185 (b)**

PORTAL EPROM EMULATOR 512K **£285 (b)**

EPROM ERASERS
UV1B 6 eproms, safety cutout **£47 (b)**

UV1T 6 eproms, timer, safety cutout **£59 (b)**

CAD/DRAWING PACKAGES

NOVACAD CAD Package for B, B+ & MASTER (See page 6 for specification)

BASIC Version **£79 (d)**

Tracker Ball/Mouse Version (TM) **£99 (d)**

TM Version & Tracker Ball **£135 (c)**

TM Version & Mouse **£125 (c)**

Plotter Driver Generator **£28 (d)**

MOUSE
AMX MOUSE WITH SUPER ART (pse specify B, B+ or Master) **£67 (d)**

SUPER ART **£43 (d)**

PAGEMAKER **£43 (d)**

3D ZICON **£21 (d)**

PAINTPOT **£21 (d)**

DATABASE **£21 (d)**

**LEADING
SUPPLIER TO THE
BBC MARKET
ESTABLISHED OVER 15 YEARS**

TECHNOMATIC

17 Burnley Road, London NW10 1ED Tel: 01-208 1177
305 Edgware Road, London W2 Tel: 01-723 0233

RB2 TRACKER BALL
RB2 Tracker Ball with Icon Master (for B, B+ & Master) **£59 (c)**

RB2 Tracker Ball with Cursor Control Rom (for Master only) **£59 (c)**

RB2 Tracker Ball 'Stand Alone' for use with NOVACAD & other software) **£47 (c)**

Cursor Control Rom for Master **£12.50 (d)**

MIRRORSOFT FLEET STREET EDITOR incl VAT **£39.50 (d)**

SOFTWARE CP/M SOFTWARE

for Acorn, Torch & Multiform Z80 Processors

MICROPRO's Wordstar Professional **£310 (a)**

ASHTON TATE's DBASE II **£310 (a)**

SUPERCALC II **£195 (a)**

SEND FOR DETAILS ON OUR FULL RANGE OF CP/M & PC DOS PACKAGES FOR BUSINESS, COMMUNICATIONS & HIGH LEVEL LANGUAGES

BBC SOFTWARE/ FIRMWARE

DATABASE MANAGEMENT SYSTEMS

VIEWSTORE
Acorn's database with display in any mode in spreadsheet or user defined card format and powerful sort facilities. Max file size 4Mb **£37 (d)**

STARdataBASE
A fast machine code, true random access database. Upto 4000 records/file, 69 fields. Fully menu driven, user defined record layout, very fast searches thru keysearch facility. Mailmerging from VIEW and WW. **£49 (d)**

MASTERFILE II
Highly popular economically priced database. 17 fields per record, file size limited by drive capacity only. (40T or 80T) **£17 (d)**

GEMINI's DATAGEM
A 24K database system offering large user defined record layout, multi level searches etc **£59 (c)**

WORD PROCESSORS

VIEW 2.1 **£37 (d)**

VIEW 3.0
New version of VIEW compatible with B+ complete with a printer driver generator. **£56 (c)**

Hi-VIEW
Disc based version of VIEW 2.1 for use with 6502 2nd processor allowing upto 47K of memory for text. **£36 (d)**

VIEWSPELL
Acorn's new rom based spelling checking utility with a 70,000 word dictionary on 80T disc.

Additional/specialised dictionaries can be created. Facilities also include wild card search for words. **£29 (d)**

VIEW INDEX **£12 (d)**

VIEW PRINTER DRIVER GENERATOR
A utility to generate a View printer driver to suit any printer. Screen driver allows viewing of text exactly as it will appear on paper. **£9 (d)**

DOT PRINT PLUS
Full details on page 5. NLQ rom for Epson Versions for FX/RX, MX and GLP **£28 (d)**

WORDWISE **£24 (d)**

WORDWISE PLUS **£38 (d)**

INTERWORD
(If you own a WW+ then quote your reg number and pay £10 less). **£49 (d)**

WORDEASE **£24 (d)**
A 16K rom based utility for WW+

SPELLCHECK III
A 16K rom based spellcheck program for View and WW. Contains 2000 words on the rom and 6000 (expandable to 17000) words on a disc. **£31 (d)**

EDWORD II **£43 (c)**

SPREADSHEETS

VIEWSHEET
Acorn's spreadsheet provides 255 cols and 255 rows and will operate in any mode. Fully compatible with VIEW and 6502 2nd processor. **£37 (d)**

VIEWPLOT
A disc based plotting program. (To be released soon). **£22 (d)**

INTERSHEET
The new spreadsheet from Computer Concepts with many advanced features like 105 col mode, holding several spreadsheets in memory at a time etc. **£39 (d)**

INTERCHART **£27 (d)**
Graphics package for Intersheet

ULTRACALC **£49 (d)**
BBC Publications very popular and well proven spreadsheet rom.

QUICKCALC **£14.50(d)**
A disc based economically priced spreadsheet package (40 or 80T Disc).

MINI OFFICE II **£14.75(d)**
A suite of inexpensive but extensive word processor, database and spreadsheet packages. (40T or 80T)

LANGUAGES

META ASSEMBLER **£145 (c)**
Multi processor Assembler full details on page 8

ACORN 6502 DEVELOPMENT PACKAGE **£43 (d)**
A macro assembler with utilities for developing large programs in assy lang. Requires 6502 2nd processor.

MACROM **£33 (d)**
A very fast full featured macro assembler rom from 6502 and 65C02 codes, allows use of macros from library disc. Assembly can be disc to memory, memory to memory, memory to disc and disc to disc thus allowing very long source code upto the length of disc in use. About 3 times as fast as ADE and 30% more economical in memory.

ACORN MICRO PROLOG **£62 (d)**
Logic programming language used extensively in the artificial intelligence field. A simple 'front end' is supplied to make syntax more friendly.

ISO-PASCAL **£48 (c)**
Acorn's full implementation of International Std Pascal on 2x16K roms.

ISO PASCAL STAND ALONE GENERATOR **£30 (d)**

OXFORD PASCAL **£36 (d)**
A fast P-code compiler and stand alone utility (40 or 80T) Network version available

BCPL **£46 (c)**

BCPL CALCULATIONS **£17.50 (d)**
Supports floating point, fixed point and fast integer calculations on BCPL

BCPL STAND ALONE GENERATOR **£39 (d)**

ACORN LOGO **£46 (c)**

LOGOTRON LOGO **£56 (c)**

BBC PUBLICATIONS OPEN LOGO **£55 (c)**

ACORN LISP ROM **£39 (d)**

ACORN FORTH ROM **£39 (d)**

ACORN COMAL ROM **£43 (d)**

MICROTEXT **£52 (c)**
A frame based authoring system from NPL for interactive computer tutoring. Disc based

MICROTEXT PLUS **£229 (b)**
Extended Features incl extra memory, control of external devices etc. Rom based.

COMMUNICATIONS

TERMULATOR **£25 (d)**
Advanced terminal emulator which includes VT52/100, Tektronics 4010, teletype emulations.

COMMSTAR **£28 (d)**
A highly popular communication rom suitable for all general purpose applications (specify BBC model)

COMMUNICATOR **£49 (d)**
A full 80 col VT100 emulation program with easy to follow screen menus.

DATABEEB **£26 (d)**
A variety of facilities for use with WS2000 Modem

DS1 DISC **£10 (d)**
Special utilities for use with WS2000

UTILITIES

ACCELERATOR **£49 (d)**

ACORN BASIC EDITOR **£22 (d)**

BROM PLUS **£26.50 (d)**

SLEUTH **£23 (d)**

TOOLKIT PLUS **£31 (d)**

EXMON II **£23 (d)**

HELP II **£25 (d)**

ACORN GXR GRAPHICS ROM **£22 (d)**
specify B or B+

PRINTMASTER **£24 (d)**

DUMPMASER supports about 40 printers **£26 (d)**

FONTWISE PLUS **£17 (d)**

HERSHEY FONT CHARACTER GENERATOR **£18 (d)**

ICON MASTER **£29 (d)**

BILLBOARD **£18 (d)**

STUDIO EIGHT **£19 (d)**

MOVIE MAKER **£26 (d)**
Two Roms + Cassette

CC SPEECH ROM **£28 (d)**

CC SPEECH ROM to Text Rom **£34 (d)**

ACORN SPEECH ROM **£15 (d)**

BBC Computer
& Econet
Referral Centre

MAIL ORDER
17 Burnley Road
London NW10 1ED
Telex: 922800

RETAIL SHOPS
15 Burnley Road, London NW10 1ED
Tel: 01-208 1177 Telex: 922800
(close to Dollis Hill ⊕)
West End Branch
305 Edgware Road, London W2
Tel: 01-723 0233
(near Edgware Road ⊕)

For fast delivery telephone your order
on 01-208 1177 using VISA / Access Card



Orders welcome from government depts
& educational establishments.

All prices ex VAT. Prices are subject to change without notice.

Please add carriage
(a) £8.50 (Datapost) (b) £2.50 (c) £1.50 (d) £1.00

DISC DRIVES



TS 400



PD 800

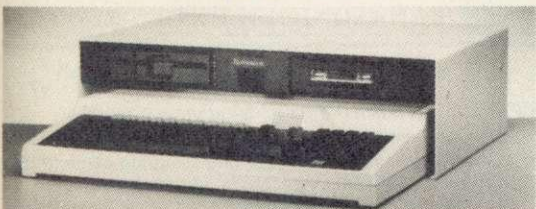

P2041 HT



PD 800 P

TECHNOMATIC offers a wide range of high quality, high performance drives to meet all needs of BBC micro users at competitive prices.

*All drives are fitted with MITSUBISHI's slim line ultra low power mechanisms capable of single and double density operation and offering very fast track access and head settling times.

*5.25" floppy drives are fitted with 40/80 track switches as standard at no extra cost. The switches are located in the front and clearly marked to indicate the status at a glance.

*The mechanisms are set inside attractively styled, sturdy metal casings painted in BBC beige colour.

*The plinth version drives provide for a neat and compact system installation giving it a more professional look.

*All drives fitted with all necessary leads and are ready for operation on unpacking. The drives with the mains power supply are supplied with a mains lead fitted with suitably fused 13A moulded plug.

*Mass storage 20 Mbyte drives are available in the following versions:

- * P20HD Stand alone.
- * P204HP With a single floppy housed in a plinth version case.
- * P214TS Top of the range with a 10 Mbyte back up streamer and a single floppy housed in a plinth type casing and supplied with backup utilities.

All models are fully compatible with Acorn's ADFS system and include a mains psu and the necessary cable connections.

ALL TECHNOMATIC DRIVES CARRY A TWO YEAR WARRANTY AS STANDARD

(Effective 01.08.86)

DISC DRIVE MULTIPLEXER

The cost-effective alternative to networking! A self-contained unit that enables up to four computers to be connected to one single or dual disc drive. No hardware modifications — simply plugs into the computers disc interface connectors. No ROMs or other software needed. All DFS commands work as normal. The switching of drives between computers is totally automatic and completely invisible to the user. This unit is ideal for installing in classrooms and other situations, where networking is not planned or necessary, or where costs must be kept low. In many cases software needs to be shared, although full networking complexity and cost is not needed. Several of these units can be connected in series to allow more computers to access the same discs, i.e. two quads connected together will allow 7 computers to share 1 drive. Units are supplied with 5' of cable per outlet as standard. Mains powered.

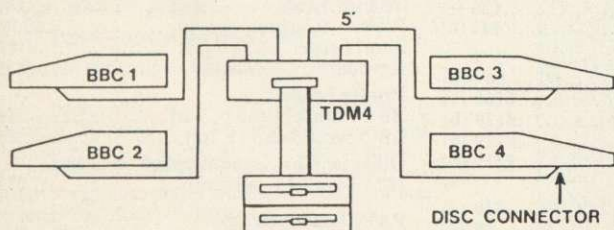

TDM4 Quad Unit (up to 4 computers)

TDM2 Dual Unit (2 computers)

SPECIAL OFFER

on

3M DISCS

FREE SWISS ARMY KNIFE

for purchasing requisite number of drives. Hurry, this is a limited offer.

LEADING
SUPPLIER TO THE
BBC MARKET
ESTABLISHED OVER 15 YEARS

TECHNOMATIC

17 Burnley Road, London NW10 1ED Tel: 01-208 1177
305 Edgware Road, London W2 Tel: 01-723 0233

ACW443 CAMBRIDGE WORKSTATION

- *A complete self-contained workstation.
- *'Bundled' software as 32016 co-processor.
- *8Mhz NS32016.
- *20Mbyte Winchester + 1 400K Floppy Drive.
- *4Mbyte RAM as standard.
- *Hi-Res Monitor *Detachable keyboard.
- *Phone for detailed leaflet.

PHONE FOR DETAILS OF RANGE OF 32BIT SOFTWARE NOW AVAILABLE

32016 CO-PROCESSOR

A second processor that brings genuine 'Mainframe' power to your BBC.

- * 6 Mhz. NS32016 CPU
- * NS32081 Floating Point Processor.
- * Bundled' languages including: Fortran-77, Pascal, C, Cambridge Lisp, 32016 Assembler, 32Bit BBC Basic.
- * 1Mbyte RAM fitted as standard.
- * Phone for detailed leaflet.

512 CO-PROCESSOR

Brings professional software to the BBC Master.

- * 10 Mhz 80186 *DOS PLUS.
- * GEM Write & GEM Draw.
- * 'WIMP' Environment with high quality Mouse.
- * Runs many 'IBM' programs — even 'Flight Simulator'!
- * Convert to/from IBM/BBC data.

DOTPRINT PLUS

A uniquely versatile NLQ ROM for the BBC Micro.

- * Built-in character font generator.
- * Built-in view printer driver.
- * Supports microspacing for professional justification in View & with disc in Wordwise/Plus.
- * True bold print as well as double width.
- * 12 character pitch as standard.
- * Fully variable pitch and line spacing.
- * Suitable for fully 'EPSON' compatible printers with quad-density graphics.
- * DOTPRINT PLUS for EPSON FX/RX and compatibles.
- * DOTPRINT DUAL for EPSON MX range.

MICROJUSTIFIED TEXT

homes of a ruling class whose right to rule was based on the ownership of land. Large estates produced money; perhaps even more important, they supplied people to fight for their owners in the early days of the

NORMALLY JUSTIFIED TEXT

homes of a ruling class whose right to rule was based on the ownership of land. Large estates produced money; perhaps even more important, they supplied people to fight for their owners in the early days of the

EPSON LQ800

Uses top quality 24 pin dot-matrix technology.

- * Superb 'letter quality' at 67cps.
- * Fast clear draft quality at 200cps.
- * LQ/Draft modes selectable from front panel.
- * Variety of fonts, usable in both draft & LQ modes.
- * Optional 'personality' modules for Diablo and IBM emulation.
- * Optional Font modules.
- * Friction feed.
- * Hi Res bit image graphics with hex density.

NEW STAR NL10	£239 (a)
NEW PANASONIC KX-P1080	£169 (a)

GRAPHIC WORKSTATION

A Powerful A3 3 pen plotter with unique accessories.

- * Resolution of 0.1mm.
- * Opto-sensor allows digitising and scanning of pictures.
- * A robust drill/router attachment allows drilling of light materials.
- * Scriber allows fine-line drawing on coated materials.
- * Basic plotter/accessories as well as supporting software is also available separately.
- * Applications software available as an option allows interfacing of the drill/router with NOVACAD.

PLOTMATE

A4 LINEAR GRAPHICS 'PLOTMATE'

- *Intercepts BBC Video Calls for direct outputs.
- *Plugs into the BBC user-port.
- *Runs with most BBC software.
- *Supporting software available.

A4M/A3M LINEAR GRAPHICS 'PLOTMATE'

- *Standard computer interfaces — suits most computers.
- *Available in both A4 and A3 versions.
- *Supporting software available.

BBC SPARE PARTS

All Prices are Retail ex-VAT

BBC & Misc:	SAA5050.....	£9.00
Keyboards.....	6845SP.....	£6.50
Powers Supply.....	UPD7002.....	£5.00
Keyswitch.....	DS3691.....	£3.50
Video ULA.....	7438.....	£0.40
Serial ULA.....	74LSOO.....	£0.24
DNFS.....	74LSO4.....	£0.24
UHF MOD.....	74LS10.....	£0.24
6502A CPU.....	74LS123.....	£0.80
65CO2 CPU.....	74LS163.....	£0.75
6522 VIA.....	74LS244.....	£0.80
6522A VIA.....	74LS245.....	£1.10
LM324.....	74LS373.....	£0.90
8271.....	74LS393.....	£1.00
88LS120.....		£3.00
BBC PLUS:	BBC MASTER:	
PAL16REN.....	1-Mbit ROM.....	£39
64K x 4 DRAM.....	MSI CHROMA	
6512A.....	IC.....	£13.50
	65SC12P-2.....	£12.50

EPSON HI-80

- * Low cost while maintaining precision.
- * A4 with 4 colour precision plotting.
- * Variety of pens available.
- * Ideal for overhead transparencies.
- * Powerful software commands allow complex plots.
- * Superb line/bar/pie charts simply produced.

HITACHI 672 PLOTTER

- * A3 four colour precision plotter.
- * Serial and parallel ports as standard.
- * Produces 'OHP' transparencies as well as plain paper.
- * 'HP' graphics language or single character commands.

PRINTER ACCESSORIES

EPSON ACCESSORIES:

Interfaces:	
8143 RS232.....	£28 (d)
8148 + RS232 + 8K.....	£75 (d)
8165 IEEE + Cable.....	£65 (d)
8148 RS232 + 2K.....	£57 (d)
8132 Apple II.....	£60 (d)
8177P NLQ for FX80 + /FX100 +.....	£99 (d)
Parallel & Serial Buffers of various size also available.	
FX80/80 + /85 Tractor Attachment.....	£37 (c)
FX80/80 + Paper Roll Holder.....	£17 (c)
LX80 Tractor Feed.....	£20 (c)
LQ800 Tractor Feed.....	£44 (b)
SHEET FEEDERS:	
8338 LX80.....	£49 (b)
8333 FX100 + /105.....	£169 (a)
8331 FX80 + /85.....	£129 (b)
8330 RX80 +.....	£129 (b)
LQ800.....	£129 (b)
Ribbons:	
RX/FX100/100 +. FX105.....	£10 (d)
RX/FX80/80 +, FX85.....	£5 (d)
LX80.....	£4.50 (d)
H180 Pen Set (Aqueous/Ball point).....	£7.50 (d)
Dust Covers:	
FX80.....	£5.50 (d)
TAXAN/Canon KP810.....	£6 (d)
FX100.....	£7.50 (d)
KP910.....	£7 (d)

TAXAN CANON Accessories:

RS232 + 2K buffer.....	£78 (d)
Ribbon.....	£6 (d)

JUKI 6100

RS232 Interfaces.....	£65 (d)
Tractor Feed.....	£129 (a)
Ribbon (Carbon).....	£2.00 (d)
Spare Daisy Wheel.....	£14 (d)
Sheet Feeder.....	£182 (a)

BROTHER HR15

Daisy Wheel.....	£18 (d)
Tractor Feed.....	£90 (a)
Ribbon (Carbon/Nylon).....	£3.00 (d)
Sheet Feeder.....	£182 (d)
Keyboard.....	£135 (a)

Printer Leads:

BBC Parallel Lead (1.2m).....	£6 (d)
BBC Serial Lead (1.2m).....	£6 (d)

Other lengths can be supplied on order:

IBM Parallel Lead (2m).....	£12 (d)
-----------------------------	---------

PAPER & LABELS

Plain Fanfold paper with micro perforations:	
2000 sheets 9 1/2" x 11".....	£13 (b)
2000 sheets 14 1/2" x 11".....	£18.50 (£4.50)

Labels 1000:

Single Row 3 1/2 x 7/16".....	£5.25 (d)
Triple Row 27/16" x 17/16".....	£5 (d)

BBC Computer
& Econet
Referral Centre

MAIL ORDER
17 Burnley Road
London NW10 1ED
Telex: 922800

RETAIL SHOPS
15 Burnley Road, London NW10 1ED
Tel: 01-208 1177 Telex: 922800
(close to Dollis Hill ☺)
West End Branch
305 Edgware Road, London W2
Tel: 01-723 0233
(near Edgware Road ☺)

For fast delivery telephone your order
on 01-208 1177 using VISA/Access Card



Orders welcome from government depts
& educational establishments.

All prices ex VAT. Prices are subject to change without notice.

Please add carriage
(a) £8.50 (Datapost) (b) £2.50 (c) £1.50 (d) £1.00

NOVACAD

Computer Aided Draughting for the BBC Micro

A sophisticated CAD package with unique facilities which are generally confined to the professional CAD packages costing thousands of pounds.

NOVACAD is being used in widely differing fields ranging from leading British industries for producing engineering drawings to Accountants' offices for producing flow charts. Architects,

engineers, plumbers, kitchen planners and many other professions requiring easy to use facilities for producing professional quality output are making extensive use of NOVACAD's unique features. NOVACAD is proving to be a invaluable teaching aid in technical schools and colleges simply because of the ease with which it can be used.

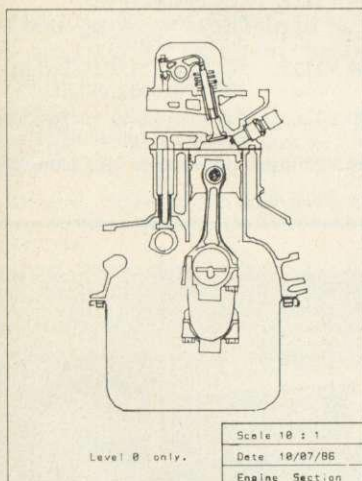
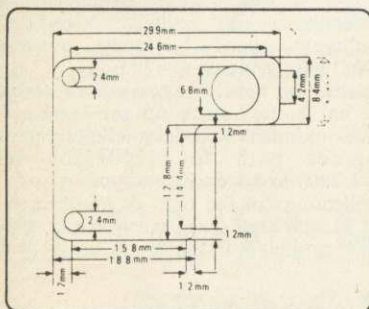

The major features of NOVACAD are:

- * Simple and easy to use with logical command sequence.
- * A large drawing area (approx 15 screens).
- * The ability to create complex icons (upto 500 lines instead of the usual 15 to 20 pixels), store them in a library and recall them at different scales and orientations.
- * A zoom facility allowing magnification of up to 20 times to insert finer details.
- * Block copy of shapes on the screen for repetitive use.
- * Text entry at any 90 orientation at any position on the screen.
- * Create multi layer drawing with 8 levels available.
- * Full compatibility with the BBC range with minimal hardware requirements yet having the capability of exploiting the potential of the extra shadow memory or the second processor's memory and speed.
- * Printer routine for Epson 80 and 136 column printers.
- * A unique facility to output to any BBC compatible plotter.

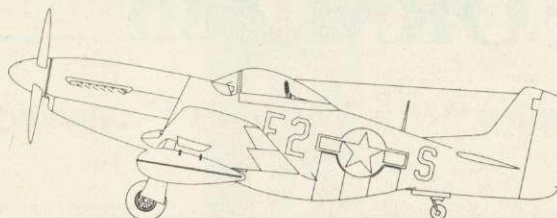
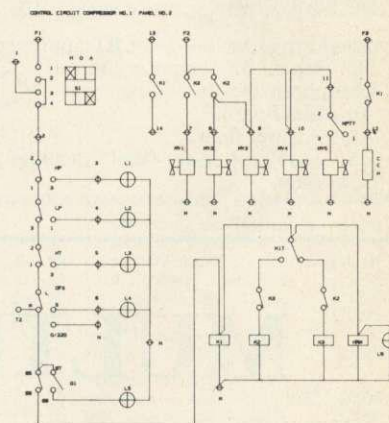
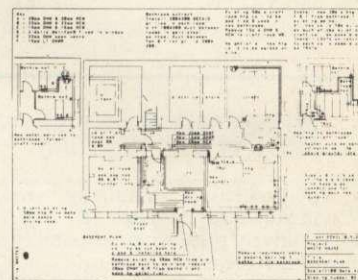

MINIMUM HARDWARE REQUIREMENTS

- Any BBC range computer with Acorn DFS.
- 40 Track single sided single drive.
- Epson compatible dot matrix printer.

With basic BBC B, NOVACAD operates in mode 4 allowing use of any 2 colours with shadow memory, it can also operate in mode 0 for higher resolution or mode 1 for allowing use of any 4 colours, and it will have additional user memory for more complex drawings. 6502 second processor will also increase the drawing speed.

NOVACAD is available in two versions

*BASIC version for cursor control from the keyboard.

*T/M version for cursor control from the keyboard, Tracker Ball or a Mouse.

OPTIONAL EXTRAS

Plotter driver generator is available as an optional extra to configure a plotter routine for any BBC compatible plotter. Pre-configured programs for the popular plotters like Epson HI 80, Hitachi 672, Plotmate, Penman and HP GL. This program allows the drawing to be scaled to the maximum plotter size thus enabling drawing of A2 and A3 sizes to be produced with equal ease. The zoom facility will enable inaccuracies of drawing on the screen to be eliminated.

ROUTCAD, an optional software package for our Graphics Workstation allows for production of shapes drawn using NOVACAD in 3D on suitable material and is ideal for a range of applications including template making and model building.

NOVACAD package includes a 16K ROM, Utility disc and a comprehensive manual.

LEADING
SUPPLIER TO THE
BBC MARKET
ESTABLISHED OVER 15 YEARS

TECHNOMATIC

17 Burnley Road, London NW10 1ED Tel: 01-208 1177
305 Edgware Road, London W2 Tel: 01-723 0233

MODEMS

MIRACLE WS4000

- * A cost effective intelligent modem that offers the best value for money bringing the world of data communication within easy reach.
- * Plain English commands make it simple to use, even for the first time user.
- * Latest Hayes-type protocol commands, auto dial, auto answer, auto speed seeking.
- * Equalisation model in V23 for line-noise filtering.
- * Many other options including upgrading to V22 and V22 bis.

MIRACLE WS2000

- * A comprehensive manually switched 'World Standard' modem.
- * Competitively priced with a capability to be upgraded for various options.
- * BT approved for V21/V23, 300/300, 1200/75 and 1200/1200 half duplex.
- * Includes BEL103/113/108 standards for use outside UK.

Optional extras include (Not BT approved).

- * SK1 chip set for computer control.
- * User port cable.
- * Auto dial Board.
- * Auto Answer Board.
- * DS1 disc for auto dial facilities on Commstar.



WS 3000 Range

APPROVED for connection to telecommunication systems specified in the instructions for use subject to the conditions set out in them.

MIRACLE WS3000 RANGE

- * A professional range of intelligent modems with full BAPT approval.
- * Auto Answer and Auto Dial facilities installed as standard.
- * HAYES protocols implemented.
- * Pulse or DTMF 'tone' dialing.
- * Plain English command structure simplifies the use of the modem.
- * Integral parallel printer port fitted as standard configurable for both input and output for process control applications.
- * A line sharing facility to differential between data and voice calls.
- * Intelligent speed buffering converts 1200/1200 terminals to 1200/75
- * Equalisation mode for line noise filtering.
- * Internal battery back up for storing 63 names, numbers and default settings.
- * Upgrade path for 1200/1200 and 2400/2400 and security encryption.
- * Applications in the field of graphics and text access, high speed telex, user to user, and user to main frame.

SPECIFICATIONS

WS4000 V2123: *CCITT V21/V23.
*300/300, 600 and 1200 half duplex, 1200/75.

WS3000 V2123: *CCITT V21/V23/Bell 103.
300/300, 600 and 1200/75

WS3000 V22: *As V2123 and also 1200/1200 full duplex.

WS3000 V22 bis: *As V22 and also 2400/2400.

MULTIFORM Z80

A unique Z80 2nd Processor with a 'MULTIFORMAT' capability.



- * It is capable of running most CP/M 2.2 format applications programs on the BBC.
- * Connects to the BBC via 1MHz bus, no restriction on the cable length. OS/M operating system on rom.
- * Integral mains psu and 64K on board ram.
- * 28 different formats including Acorn Z80, RML 380Z & 480Z, EPSON QX, Amstrad, Osborne etc, supplied on the library disc with the utility to create additional formats.
- * Emulates the two of the most commonly used CP/M terminals, HAZELTINE 1500 and ADM-3a in addition to the Acorn VDU making installation of most of the software packages easy.
- * Utility to inter convert ASCII text wordprocessed on a standard BBC and under OS/M or CP/M.
- * Multiform is fully compatible with Acorn's 8271 and 1770 DFS on models B, B plus and the Master.
- * Single density dfs allows single density CP/M format use. Double density dfs allows both single and double density CP/M formats to be used.
- * Single or dual, single sided or double sided and 40 or 80 track drives can be used provided that they match the CP/M software format to be run.
- * Dual drive will allow two separate formats to operate simultaneously for data transfer making it ideal for use in environment where machines with different formats are in use.
- * Utility to read and write on IBM PC DOS discs available as an optional extra. Utility will also format a PC DOS disc.
- * Multiform Z80 is supplied with a OS/M operating system rom, System disc and a Library disc. Please specify the DFS type and the drive format when ordering.

BBC Computer
& Econet
Referral Centre

MAIL ORDER
17 Burnley Road
London NW10 1ED
Telex: 922800

RETAIL SHOPS
15 Burnley Road, London NW10 1ED
Tel: 01-208 1177 Telex: 922800
(close to Dollis Hill ☺)
West End Branch
305 Edgware Road, London W2
Tel: 01-723 0233
(near Edgware Road ☺)

For fast delivery telephone your order
on 01-208 1177 using VISA/ Access Card



Orders welcome from government depts
& educational establishments.

All prices ex VAT. Prices are subject to change without notice.

Please add carriage
(a) £8.50 (Datapost) (b) £2.50 (c) £1.50 (d) £1.00

EPROMER II

Eprom Programmer for the BBC Micro Series



Epromer is supplied with a integral mains psu, all the necessary cables, a manual and software on disc. Disc also contains the rom image for use with sideways ram. Rom based software is available as an optional extra if required.
Epromer is fully compatible with Acorn DFS on the BBC B, B+ and the MASTER.

- * A sophisticated Eprom Programmer that uses the latest Eprom Programming technology to simplify the use of the programmer and at the same time allowing the programmer the full control of the programming process.
- * It handles the full range of popular single rail Eproms up to 28256, all except the 27256 are programmed in a single pass.
- * Powerful menu driven software makes the programming of eproms simple and efficient.
- * Selectable programming voltage 25/21/12.5V.
- * Two programming option, standard and algorithmic for eproms capable of high speed programming. 27128 can be programmed in just over 2 mins.
- * Single address to full eprom address selectable for any of the epromer function ie blank check/read/burn/verify.
- * Full screen editor with input in hex or ASCII.
- * Software interface for special programming requirements eg programming alternate bytes etc.
- * Many other useful utilities included.

Please send for full specification sheet.

META VERSION THREE

The only package available in the micro market that will assemble 27 different processors at the price offered.

Now Available

- * Assembly for even more processors
- * Now over 70k long on 2 16K Roms and 2 Discs
- * Dozens of new options, features and directives

The Original META system sold hundreds worldwide; it's being used in Universities, Polytechnics, British Telecom, the BBC, the MOD etc etc.

Now there's an even better version. It is supplied on two 16K roms and two discs and it is fully compatible with all BBC models including Master and gives you complete Editing and Assembly facilities for all the listed processors:

1802	6800	8085	6305
HD 64180	6802	Z8	6801
Z80	68HC11	68120	6803
6502 (including all CMOS variants)	68000	68121	6805
65C812	8048 Series	6808	6804
65C816	8051 Series	6301	6809
	8080	6303	

META uses the appropriate standard mnemonics for each, eg. LD (HL), 0ABH in Z80 and MOVE. B DO, \$50 (A5, D6.L) in 68000 etc.

Full nestable Macro facilities are provided, and nestable conditional Assembly, (IF/ELSE/ENDIF), Modular source code (including parameter passing). True local and global labels, 32 bit labels and arithmetic (incl. MUL, DIV, AND, OR, XOR, SHL etc). 30 ways to send object code during Assembly, including Intel Hex, S.Record, Binary etc to Disc files, RS423, EPROM emulators etc, local reassembly and over 50 directives, including DS.X, DC.X, EQUX, FCB etc).

Wordwise-style Editor integrated in with Assembler; Search/Search-Replace, Block copy/delete, markers etc; dozens of special features and functions for Assembly code programmer. Fast and Friendly to use.

Plus special new serial Communicator Area with Complex Option page etc.

Send for your detailed spec sheet on the META Assembler and the PORTAL EPROM Emulators. Set of disassemblers and Logic Analyser coming soon.

Please specify the computer type when ordering.

PORTAL EMULATOR

- * Provides real time emulation of all listed eproms at 150 ns.
- * Totally software driven by (META).
- * Compatible with 'piggyback' processors.
- * Upto 4 portals can be used on the same BBC lead.
- * Each PORTAL has a lead terminated with a 28 pin header to plug into the socket you need to emulate.
- * Various options available for sending code: eg use two PORTALS for 16 bit data bus with sequential PORTAL skipping.

PORTAL is available in two versions:

PORTAL 128 for 2716, 2732, 2764, 27128.

PORTAL 512 for all of the ones listed above + 27256 and 27512.

B O O K S

No VAT
Carriage
Code
(c)

LANGUAGES:

6502 Assy Lang Prog.....	£19.95
6502 Programming.....	£16.95
8086 Book.....	£23.95
Acorn BCPL User Guide.....	£15.00
Acorn FORTH.....	£7.50
Acorn LISP.....	£7.50
S-PASCAL.....	£7.50
Acorn ISO Pascal Ref Manual.....	£12.50
Intro to COMAL.....	£10.00
Intro to LOGO.....	£7.50
Micro Prolog Ref Manual.....	£12.50
Creative Sound.....	£7.50
Introduction to Pascal.....	£16.50
Prog the Micro with Pascal.....	£8.50
The UNIX Book.....	£7.50
Unix User Guide.....	£19.95
Understanding Unix.....	£18.45

BBC MICRO BOOKS

FOR BEGINNERS:

BBC User Guide Acorn.....	£15.00
BBC PLUS User Guide.....	£15.00
Drawing your Own BBC Programs.....	£6.95
Introducing the BBC Micro.....	£4.50
Mathematical Programs in BBC Basic.....	£4.50

PROGRAMMING/UTILITY

Advanced User Guide.....	£12.50
Adv BASIC Rom User Guide.....	£7.50
Advanced Prog Tech for BBC.....	£8.95
Applied Ass./Lang on the BBC.....	£9.95
BBC Micro Advanced Programming.....	£9.95
BBC Micro Sideways ROM's RAM's.....	£9.95
BBC Micro Sideways Roms.....	£9.95
B. Smith.....	£9.95
Guide to the BBC ROM.....	£9.95
Exploiting BBC BASIC.....	£6.95
Further Programming for BBC.....	£4.00

Programming the BBC.....	£6.50
Structured Programming.....	£6.50
Using BBC BASIC.....	£10.00
View 3.0 User Guide.....	£12.50
Viewstore.....	£12.50
Viewsheet.....	£12.50
Word Processing on BBC (Wordwise + Epsosn).....	£5.25

SOUND & GRAPHICS:

Advanced Graphics with BBC.....	£6.00
BBC Graphics & Sound.....	£7.50
Creative Sound on the BBC.....	£9.95
Graphics on the BBC Micro.....	£6.00

DISC DRIVE SYSTEMS:

Advanced Disc User Guide.....	£14.95
BBC Micro Disc Companion.....	£7.95
Disc Book.....	£3.50
Disc Programming Techniques.....	£7.95
Disc Systems.....	£6.95

APPLICATIONS:

BBC Filing Systems & Databases.....	£7.95
Business Programming on BBC.....	£7.95
Business Applications on BBC.....	£7.95
DIY Robotics & Sensors.....	£6.95

PROFESSIONAL SOFTWARE

Wordstar made easy.....	£16.95 (c)
Introduction to Wordstar.....	£17.95 (c)
Wordstar Handbook.....	£11.95 (c)
dBase-II for the first time user.....	£16.95 (c)
Understanding dBase-II.....	£22.95 (c)
Understanding dBase-III.....	£22.95 (c)
Multiplan Made Easy.....	£18.95 (c)
Multimate Complete Guide.....	£16.95 (c)
ABC of LOTUS 123.....	£15.95 (c)

LEADING
SUPPLIER TO THE
BBC MARKET
ESTABLISHED OVER 15 YEARS

TECHNOMATIC

17 Burnley Road, London NW10 1ED Tel: 01-208 1177
305 Edgware Road, London W2 Tel: 01-723 0233

EDUCATIONAL SOFTWARE

We are pleased to announce that we now stock the full range of BBC Publications Educational software for the BBC computers. This software which is in many cases developed alongside radio and TV programs from the BBC Education Department, has all been tested in many schools, and by education experts to ensure the high quality one would normally expect from BBC. These packages supplement the class room learning by providing moving and colourful graphical displays which normally cannot be easily produced on the blackboard and help in ensuring clear understanding of a variety of subjects. The software has received wide acclaim from teachers, and in the educational press. All cassette programs transfer easily to disc, and all disc programs can be run on 40 or 80 track drives.

PRIMARY LEARNING

ASTRONOMY

Aimed at the 9-12 age group, programs include Phases of the Moon, Eclipses, Seasons of the Year, Planetary Motions and Lander which is a gravitationally accurate game. All programs feature colour graphics. **£11 (d)**

COMPUTERS AT WORK: THE WORK GAME

Uses the technique of computer synchronised audio to illuminate two of the most important applications of computers — robotics and information technology. Includes a complete database program, tutorial on word processing principles, and robot control program driven by a logo-type language. **EC £16 (c)**

DRAWSTICK

For children aged 8 upwards allowing them to create pictures, charts, maps and diagrams. It is sufficiently sophisticated for use by older children and adults. Pictures are saved in a compressed form, and can be incorporated in your own programs. Uses keyboard or joystick. **Cassette £8 (d)**

INTRODUCING GEOGRAPHY

Four exciting graphic adventure simulations to bring geography to life for the 9-13 age group. River involves navigating a river's course to the sea. In Flight, you fly an aircraft round the world. Summit takes you up Mount Everest, and Nomad involves survival in the desert. **£16 (d)**

MATHS WITH A STORY 1

Four primary-level maths programs for children of a wide range of abilities. Topics include symmetry, co-ordinates, and probability. **Cassette £8 (d)**

MATHS WITH A STORY 2

These further four maths programs are for the same age/ability range as pack 1, and cover similar topics, from different angles. **Cassette £8 (d)**

NUMBER GAMES

Six maths programs designed to please the eye and stimulate the mind of any active and adventurous child aged 8 upwards. **Cassette EC £7.50 (d)**

USING YOUR COMPUTER

A friendly and original introduction to computers using the computer synchronised audio technique. Written for a 8-12 year old but also suitable for any complete novice. Total of 80 minutes of audio material and 14 programs. **Cassette £24 (c)**

WORD PLAY

An elegant but simple program to introduce primary school age children to the concept of word processing. Search, delete, justify etc have small animal icons associated with them. Fun manual for small children. **Cassette £10 (d)**

WORD MOVER A simple text editor.

Cassette £8 (d)

SECONDARY LEARNING

ADVANCED LEVEL STUDIES: STATISTICS

Six programs covering the central concepts and principles of statistics. Topics covered are Discrete Data and Binomial Distribution, Continuous Data and the Normal Distribution, Hypothesis testing and confidence intervals, Central Limit theorem and Estimation, Simulations, Correlation and regression. **£23 (d)**

ADVANCED STUDIES: GEOGRAPHY

Four programs examining aspects of social geography — traffic and town planning, drainage basin management and planning for industry. Users can alter the models. Details in the comprehensive manual. **Cassette £10 (d)**

INSIDE INFORMATION

Designed to provide a basic introduction to information technology for young people and adults. The course assumes no prior knowledge of the subject and is suitable for use in secondary schools, further education colleges, ITeCs and adult education centre. This software can be used alone, or in conjunction with the BBC's Inside Information radio series. **Prog Cassette £10 (d), Audio Cassette £5 (d), Book £8 (d)**

OPEN LOGO

Developed by the Open University to provide a full implementation of Logo — the language of learning — for the BBC Micro. 2 × 16K ROMS and two detailed manuals (120pp and 300pp). **Cassette EC £55 (c)**

SCIENCE TOPICS: WAVES

A secondary level physics program allowing the student to learn about waves by displaying waveforms on screen. Parameters can be altered and the results observed immediately. **£14 (d)**

SCIENCE TOPICS: RELATIONSHIPS

A secondary level biology program giving a sophisticated simulation exercise for students, based on data from the World Health Organisation. You are malaria control officer for an African village, and you must use the right combination of drugs, pesticide and education to combat the disease. **£14 (d)**

SCIENCE TOPICS: BONDING

A secondary level chemistry program designed to reinforce and strengthen students' concept of the bonding of elements. Transfer and sharing of electrons are both shown graphically. **£14 (d)**

SCIENCE TOPICS: ELECTROMAGNETIC SPECTRUM

A secondary level graphical adventure designed to test your knowledge of the

electromagnetic spectrum. You are lost in space, and you must build a radio, perform spectroscopic analysis etc. to complete the adventure. **£14 (d)**

SCIENCE TOPICS: ELECTRONICS IN ACTION

A secondary level program about using computers for control. The pack gives three simulations of control systems. Control is achieved using a subset of 6502 assembly language. A program editor is supplied. **£14 (d)**

SCIENCE TOPICS: NEWTON AND THE SHUTTLE

This secondary level interactive program in three parts follows the space shuttle from launch to recapture of a satellite in space. Students knowledge of Newtonian mechanics is tested at each stage. **£19 (d)**

SCIENCE TOPICS: ECOLOGY

This program allows students to take the part of groups who manage a nature reserve according to their own special interests. The object is to keep all groups satisfied. **EC £19 (d)**

SCIENCE TOPICS: POLYMERS

Students run a manufacturing company and must make decisions as to the best materials to use for their products. They compete with a computer run rival company. Two areas of manufacturing are featured — car parts and kitchen equipment. **EC £19 (d)**

SECONDARY SCIENCE: MICROTECHNOLOGY

This software for the 14-16 age group will help students understand certain fundamental concepts in basic electronics. The pack contains Logic and Resistor Tutors, a Servo circuit simulation and a Circuit Design program. **Cassette £7**

SECONDARY SCIENCE: THE MOLE CONCEPT

A computer synchronised audio program which explains definitions of atomic and molecular masses and attractively depicts molar equations. The audio track is written and presented by Fred Harris. **EC £16 (c)**

SECONDARY SCIENCE: UNIFORMLY ACCELERATED MOTION

A physics program which illustrates basic equations, uniform acceleration under gravity and the idea of terminal velocity. The medium is computer synchronised audio. **EC £16 (c)**

VU-TYPE

The popular 'sight and sound' touch-typing tutor using colour graphics. The layout and parameters can be altered. 23 exercises can be loaded from disc. **EC £15 (d)**

GENERAL

GAME CORE

This software gives you all the information and intelligence routines you need to write simple and highly absorbing board games for your computer. **Cassette £9 (d)**

MONITOR

A professional tool for machine-code programmers, suitable for assembly language experts and beginners alike. It is also ideal for teaching assembly language. **EC £30 (d)**

TOOLBOX 2

25 programming aids for the BBC Model B. Book (essential) sold separately. Program includes machine code monitor, disassembler, fast flood fill, sprite generator/mover, and many more. **Manual £9.50 (d), Cassette £9 (d)**

ULTRACALC 2

An electronic spreadsheet program with all the necessary built-in features. Ideal for business and personal management. Graphics utility disc included free of charge. **£47 (d)**

VU-TYPE PROFESSIONAL

An enhanced and expanded version of Vu-type including many 63 Pitman-approved exercises. **£19 (d)**

WHITE KNIGHT Mk 12 Disc £16 (d);

BATTLEFIELDS £8.50 (d)

A VOUS LA FRANCE

A home study aid for any one learning French developed in conjunction with BBC TV program of the same name. **Program Cassettes (2) EC £12 (d)**

Book £5.25 (d)

DEUTSCH DIREKT

A disc based German vocabulary learning program with audio cassette to help with pronunciations. **Disc with audio Cassette EC £16 (d)**

Book £5.95 (d)

Disc **EC Network Compatible** Audio Cassette
Cassette based programs listed above can be supplied on disc at an extra charge of £1.50 per cassette, please specify the format required.

LETTERS

Write to Letters, Acorn User, 141-143 Drury Lane, London WC2B 5TF

ELECTRON USER GROUP

Sir, I am starting a user group for Electron owners, and would be grateful if you could publish my full address so that potential members can contact me.

While based in Cheshire, I would welcome enquiries from anywhere, as the group will be postal. There are no fees, the idea being to encourage contact and help between members. It will probably produce a cheap but informative newsletter to which members will contribute.

Finally, could I ask that enquirers enclose a stamped addressed envelope for a reply. Thank you in anticipation.

Michael O'Donnell
5 Worthington Close
Runcorn, Cheshire WA7 2QG

KNOCKED SIDWAYS

Sir, Add my opinion to those which say that too high a level of pre-knowledge is assumed by too many authors of articles and manuals.

The advertisement for a well known 32k shadow RAM board says: 'Use the top 20k of the expansion RAM as the screen display memory, leaving all the standard BBC RAM free for programs.'

That's clear enough, you say. Yes, but the manual is completely incomprehensible except to a person with a good working knowledge of the operating system of the Beeb. I can't understand for instance if the above refers to *any* program, or only user written ones.

The July issue of *AU* itself is at fault! The article Helping Hand says near the end: '... or perhaps to place the Help file and its routines in sideways RAM. The reader

should have enough information to tackle these problems and extend HELP as much as he or she desires.' Indeed!

This in spite of the often expressed editorial opinion that there is not enough help for users of sideways RAM. The article in the March issue on 'reading' and 'writing' bits (or bytes?) to swRAM is useless to me; and in spite of a promise that a future issue would contain aids to enable complete Basic programs and routines to be stored to and accessed direct from swRAM, nothing has appeared.

I suggest that all articles are first read by a non-technical person and those assuming a high level of pre-knowledge be returned to the author for re-writing. Don't be afraid that you will lose readers by teaching Granny to suck eggs. The technically expert can skip what are to them irrelevances.

After all I still buy it, and I have been skipping large chunks of technicalities in every issue.

Brian E Battersby
Oldham

PUTTING THE BRAKE ON BREAK

Sir, Bruce Smith in his Master Review (*AU*, March) refers to 'hecklers who bemoan' the lack of a facility to disable the Break key on the old BBCs. May I add my name to that list of hecklers. When using my BBC B for word processing with *View* I quite often hit the Break key in error as it is next to 'Delete Character' (F9). Though text can be recovered by typing OLD, if I am using EDIT some material is usually lost. Besides it is an infernal nuisance to have to go through the recovery process.

He writes 'if they knew anything about programming they would know that the software key

to do this has always been there'. I do not know anything about programming but would nevertheless be very grateful to know how to disable the Break key. Please could you explain the routine.

Dale Serjeantson
Barnes, London

The normal action of the Break key can be prevented by intercepting the Break intercept vector with *FX247, *FX248 and *FX249. The techniques for using these were discussed in the July 1985 issue (page 145) by Mark Dove.

View 3 has adequate Break protection; in *View 2.1*, typing OLD will restore any text 'lost' by accidental pressing of the Break key. The screen mode can be preserved after a Break by means of *FX255,3,248, or - more permanently - by making the mode selection link on the keyboard. To select mode 3, switch numbers 7 and 8 (on the right or at the top) must be linked.

An even simpler technique is to make a small Break key guard out of cardboard.

TROUBLE WITH COMPATIBILITY

Sir, I agree with Mr L. Cool of London (Letters, July) about incompatibility of standard BBC B software. As a Beeb B+ 128k owner and a regular *AU* and *MU* reader, I would have thought that the software houses would have said something about it but alas not, it seems. People like me who don't have much money to spend must get the feeling that they are being ripped off.

Is there anything I can do to get the software to run? I send back the software to the software houses and they send it back saying it's OK on a standard Beeb but they can't try it on a B+ 128k.

All the software loads OK but then it either does not run or the graphics are mixed up. Surely there must be a way of altering the OS or a program patch that will emulate a standard Beeb? If not, can you explain the incompatibility between the standard Beeb and the B+ 128k?

The software below seems OK on a 128k:

Frankenstein 2000 (Icon)
Chuckie Egg (A&F)
Tempest (Superior)
Cylon Attack (A&F)
Repton 2 (Superior)
Zorakk the Conqueror (Icon)
The Genesis Project (ASL)
Drain Mania (ASL)
Bug Eyes 2 (ASL)
Megasports (ASL)

The following software does not run on a 128k: *Flip* (ASL), *3D Grand Prix* (S Invasion), *Caveman Capers* (ASL), *Space Agent Zelda* (ASL), *Chrysalis* (ASL).

S M Adams
Malpas, Cheshire

QUICK-SCORING MATCH PLAYER

Sir, Great magazine! I've been receiving it since the third issue and it has improved greatly. I find the articles covering products particularly useful.

I enclose my reader survey sheet and I would also like to offer you my best scores on my favourite games. I have played the computer at *Match Day* and beaten it 14-0. This score came after many hours of discovering the quickest scoring technique, which is to run straight down the right wing then shoot diagonally into the goal.

Also, I notice you publish no high score for *Commando*, so I would like to offer my score of 123,600 which is improving almost every day.

K Blatcher
Westcliff-on-Sea, Essex

CLOWNING AROUND

Sir, Michael Lloyd (Letters, July) asks for help with *Circus*. I suggest you type in exactly what it asks you for. Where you need to make a decision (like going north, south, etc) I suggest you move in the first one or two games nearly randomly, making a map as you go. After you make a map of all the outside locations, head for the car, open the boot and get everything in sight. Move back to the tent and map that as well. Then start to play seriously and complete the game.

A few clues? For a start, the clown wants you to dress up for the occasion. It isn't the bucket that needs kicking. Maybe the sealion is hungry. Vandalism is all part of this game, so take it out on the door if you don't like it!

Plain talk? No-one should need to use plain talk. If you are going to read those instruction manuals of yours you are going to have to put up with jargon. And there is no way you can get round that. If you are going to even start to program a computer you have got to have some idea as to the differences between a byte, a bit and a nybble.

Jonathan Day
Stockport, Cheshire

DUMP FOR A COPAL

Sir, Recently I got a Copal SC-1000 dot matrix printer from Cambridge Computer Centre and I am very pleased with its performance in wordprocessing. However, I am a bit disappointed that it's not Epson-compatible as far as screen dumps go.

So far I have not managed to write a working dump, and I was wondering if there is anyone out there who owns a Copal SC-1000 or 1200 who has a screen dump which will work with these print-

ers. I'm tearing my hair out because I can't (as yet) use my printer with AMX *Super Art*, or any of the excellent graphics programs featured in your magazine.

Also, is it possible to change a printer's controlling firmware, perhaps to an Epson one? If this is possible it would solve all my problems.

I am a regular reader so perhaps if anyone can help me, they could contact *Acorn User*, or write in to the letters page.

Anyway, congratulations on a truly excellent, much improved and much worth the extra few pence, magazine.

Tom Oswald
Cambridge

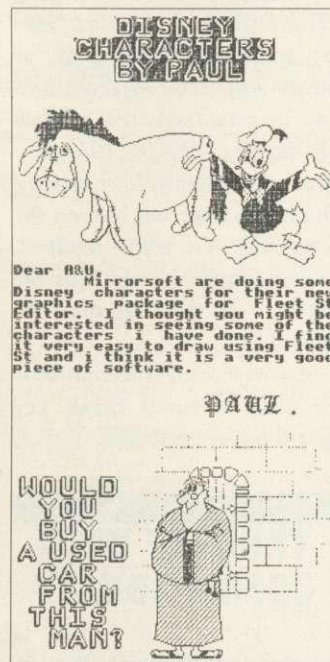

ELK OWNER DEMANDS MORE

Sir, After owning an Electron for six months, and reading your publication for five, I must complain about your lack of articles for this very popular machine. You could at least provide a part of the magazine for Electron owners to converse together and discuss matters which do not concern the Beeb or the Atom.

The Electron is a much-praised

machine and most of the major software companies now support it. Electron owners are always comparing their machine to a Beeb - but that is like comparing a ZX81 to an Amstrad CPC464.

As for *Acorn User*, if your magazine ever lowered its standards or drastically changed its format, I would have to go back to another magazine which is currently not half as good as yours. The best part of *AU* must be the Abuser's Diary - more please!

Mark Richards
Brixham
Devon

Our policy is to get Electron (and Master) owners to build on the techniques developed on the BBC and the Atom. All these machines have a common heritage and that should not be lightly thrown away. The Acorn Forum is there to pull machines together, not pull them apart. And it's easy to see at a glance from the Yellow Pages index what will work on the Electron. As we've said in the past, we rely on *you* for articles - so send them in.

MEET US HALFWAY, GUYS

Sir, I have long since resigned myself to the phenomenon of ROM clashes, but must admit surprise when I found that *Mini Office II*'s spreadsheet software would not run with *Pagemaker* ROMs on board. Naive perhaps, but nobody's perfect.

It would appear that the spreadsheet executes a star command which is in the *Pagemaker* support ROM and, bingo, the machine goes belly up.

Easy, you might say. Just turn off the offending ROM. Locations &2A1 to &2AF contain the active ROMs so just set the chosen one to zero and the ROM goes away until the next soft Break. You can type *HELP to see if it is still

there and if it has not disappeared hit Break and then try another location, eg ?&2AB=0.

The implications, however, lead me to wonder just what the software manufacturers are trying to prove. Think of it this way: *Mini Office II* is an excellent piece of software and its spreadsheet is fast and versatile. From the spreadsheet some super graphics can be produced, eg pie-charts, which can then be saved to disc. Using *Pagemaker* these screen images, together with *Mini Office II* wordprocessing text, can be incorporated into an A4 size document to make a very effective report. Wonderful, but for the ROM clash.

On the basis that you are probably not going to be continually moving ROMs around inside the Beeb, natural logic says why not put the ROM disable commands in the !BOOT file? Foiled again! *Mini Office II* seems to have its own disc I/O routines and, although the disc can be catalogued, the !BOOT file cannot be accessed, read or written using standard DFS commands. OK, so it is possible to set up another disc with an initialise routine and a prompt to load the appropriate system disc, but what a pain.

To add insult to injury, both *Mini Office II* and *Pagemaker* boast the ability to use the AMX mouse. You would have thought that the suppliers, Database Publications and Advanced Memory Systems, would have talked to each other about it. Their credibility as serious business people just took a nosedive in my perception.

So I am left to join the expanding ranks of frustrated users by saying to the software publishers, we don't expect 100 per cent software tolerance but meet us halfway, guys! Protect your software by all means but give us a little flexibility to enable us to tailor the start-up files to fit our configurations.

Eric Warmington
Camberley, Surrey

LETTERS

MICRO SPORTS AID

Sir, As the man behind my successful sporting wife (and PE teacher) I often find myself organising sports clubs and the appropriate ladders/leagues/tournaments, etc.

Do any of your readers know of a software package (commercial or otherwise) that would assist me? I already have word-processing and spreadsheet facilities but I am looking for something more specialised.

P M O'Brien
BFPO 57

NEVER MIND THE HEAT . . .

Sir, If you live in the tropics the problem with computers and disc drives is not so much the heat as the humidity. I reckon that we lost 20-odd discs last week as a result of very high humidity.

What happens is that the discs oxidise and when you use them they deposit a nasty goo on the drive head. This sets like rock and does nasty things to the discs. Proprietary head cleaners turn this goo into an even harder rock.

The answer is to clean the drive heads frequently with a matchstick. I know the manufacturers will shudder but our engineer does this to 50 IBMs regularly and it works.

So far as discs are concerned, unless you have a de-humidifier, keep them in a box with a 15-watt bulb lit all the time.

D W Greenwood
Suva, Fiji

MORE ROMS ON DISC

Sir, Since people seem to be writing to complain about the lack of software making use of extra memory/sideways RAM, how

about a list of what is available?

To start it off, here is my contribution of what will run in sideways RAM on the B+ 128k:

- *Speech!* (Superior Software)
- Utility RAM (CCD Computer Services, Winslade Barton, Clyst St Mary, Exeter EX5 1AT). Gives teletext adaptor software.
- Morley teletext adaptor software.

No doubt software houses are scared of piracy but I for one would rather pay the same price for ROM images on disc as they can then be pumped in as required without opening up the machine. Also you do not have to unplug or disable a ROM that clashes.

I wish CCD, Morley and Superior well and hope that other software houses take note. There are quite a few ROMS that I would buy if they were available on disc.

Paul F Tolson
Dewsbury, W. Yorks

INTER VIEWS

Sir, May I please set the record straight regarding our Inter series ROMs. On several occasions in the last few months, including page 29 August issue, a totally misleading non-fact has been stated.

The Inter series ROMs *do not* require a dedicated ROM in order to pass data between them. The large number of people quoting this from your magazine shows how every piece of information is carefully gleaned and remembered! Unfortunate when mistakes creep in, though.

Inter-Sheet is 32k long, split into two ROMs. We assume that if someone only has room for one of the ROMs, they probably haven't got a ROM expansion board and therefore won't have other Inter series ROMs plugged in. In this case, commands to transfer data would be useless. By this reasoning, *Inter-Sheet* is split so that all

the main spreadsheet functions are in one ROM and all those concerned with data transfer are in the other. Thus, when short of space, the 'Sheet' chip is plugged in alone, offering all features except data transfer. On the other hand, *Inter-Chart* is one chip containing its own data transfer commands. So too is *Inter-Word* and so too will be *Inter-Base*. There is no 'extra' chip for data transfer.

Whoever first wrote it, take 100 lines: 'I promise to check things before I write them.'

Rob Pickering
Computer Concepts
Hemel Hempstead
Herts

FRUSTRATED DESIGNER

Sir, Congratulations on your very interesting insight into the workings of *Elite* in the January and February issues, and the superb Commander File Editor. I have now completed both missions. (The first three times I failed the first mission because I never managed to find the constrictor. I rectified this by changing my mission control back to zero so I was set the mission again - and found the constrictor immediately.)

In the January issue, you mention briefly the D. information files but then dismiss them by saying that the commander files are 'far more interesting'. I would very much like to be able to edit the D. files in order to design my own set of spacecraft. This would be of great use to all players of *Elite*, as an inexperienced player could design ships with a low maximum speed and manoeuvrability, and also weak shields, whilst an experienced player could design a host of formidable opponents to tax his or her skills to the limit. Or maybe we could just have a few hints on how to interpret the data in the files. I have tried comparing various D. files and, although I have

found some similarities, I have come no closer to understanding how to change the data meaningfully.

I have also turned my attention to *Revs 4 Tracks* in an attempt to design new tracks, but whenever I make the slightest change to the files, the machine does a reset as soon as it has loaded. Could you help me on this one too? I would be very grateful if you could answer these questions, because it would greatly enhance my, and no doubt many others', enjoyment of these games.

Finally, here is a useful one-liner to perform a memory dump. It prints unprintable codes as the teletext block character (255). All leading zeros are printed. The start address can be entered in hex preceded by the & sign or in decimal.

```
*KEYO I. "Start:"B$:B%=EV.
(B$):CL.:DIMA (8)
:REP.:P.;~B%.:F.C%=1TO8:A
(C%)=?B%:V.32,-48*
(LENSTR$~A(C%)=1)
:P.;~A(C%);:B%=B%+1
:N.:V.32:F.C%=1TO8:V.
(A(C%)>126)OR(A(C%)<32)
ORA(C%):N.:P.:U.FA.M
```

I M Goldby
Dangerous (without cheating)
Broxbourne, Herts

BRIDGING THE GAP

Sir, I have been scanning the pages of *Acorn User* for months in search of any programs which play Bridge.

Surely, when the BBC micro plays a good game of chess or simulates a jet or racing car it must be possible to devise a program which will play Bridge and provide invaluable training to the thousands of devotees throughout the country?

Go to it software houses - here's a niche waiting to be filled!

B Marshall
Cambridge

SIDWISE ROM/RAM EXPANSION FOR THE BBC MICRO

- ★ Plug-in-and-go construction
- ★ No soldering required
- ★ Ideal tool for Sideways ROM, program development
- ★ 16k Battery backed CMOS RAM, optional extra
- ★ Software for Sideways ROMS may be down loaded and run in RAM under a true Sideways environment

PRICE £38.00 plus £1 p&P plus VAT

SIDWISE PLUS Sideways ROM expansion board for the BBC B+MICRO
PRICE £29.95 plus £1 p&P plus VAT

COLOUR-STICK An advanced lightpen package for the BBC MICRO with icon driven art program. Recommended for Educational establishments. Available in 40 & 80 track disc format or Econet
PRICE £34.95 plus £1 p&P plus VAT

SOFTWARE - CUSTOM ROM/RAM WRITER Utility to produce a ROM image for loading into EPROM or SIDWISE RAM
PRICE £14.95 plus 50p p&P plus VAT

Cheques made payable to Advanced Technology Products Ltd. Allow 28 days for delivery. ACCESS/VISA ACCEPTED. Carriage to be added to advertised price, then add VAT to the total.

SIDWISE

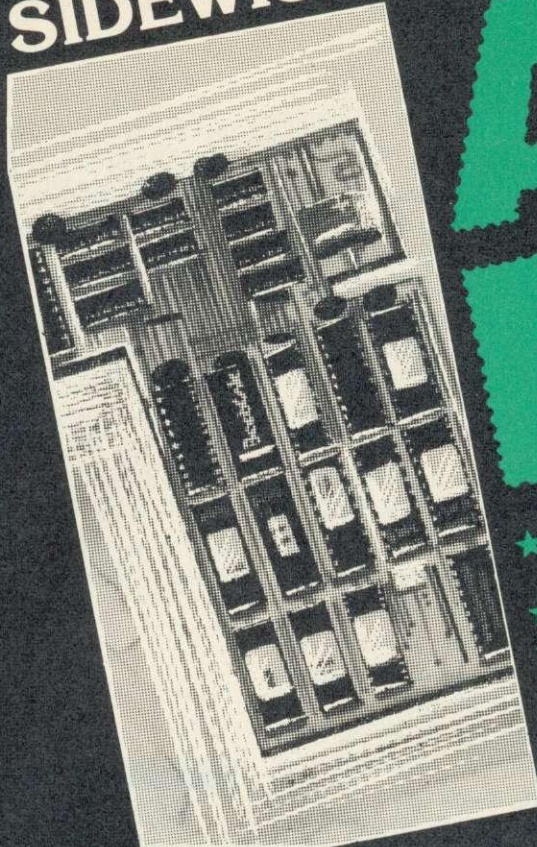

ATPL

- ★ SIDWISE (AS ILLUSTRATED)
- ★ SIDWISE PLUS
- ★ COLOUR STICK
- ★ SOFTWARE PACKAGES
- ★ EXTENSIVE DEALER NETWORK

CONTACT A.T.P.L. STATION RD, CLOWNE, CHESTERFIELD S43 4AB TEL: 0246 811585

If YOU ever key CHAIN, LOAD, *RUN, *ACCESS, *LOAD, *COPY, *DELETE, *COMPACT, *INFO, *TYPE, *DUMP or *EXEC, then YOU need . . .



BEEBAID



DISC MENU FACILITIES

Three menus available, Load menu, Run menu, and Disk Free Space display. All Menus are mode 7 colour displays accessible using a * command, or more efficiently using L/Break, M/Break and O/Break.
Menus are 'networked', switch between them at the touch of a key.
Load menu loads BASIC programs and automatically lists them with page mode set on - with a single keystroke! However, if you have The Acorn BASIC Editor Rom in your machine, it is entered with insert mode set.
Load menu also loads machine code programs at the correct address for subsequent disassembly. Automatically detects a Rom and prompts for a destination Ram socket.
Touch the COPY key and invoke the Copy menu. Select the files, select the target drive, and BEEBAID does the rest for you. Handles duplicate files, locked files and multiple destination drives.
The Run menu enables BASIC and machine code programs to be executed easily - by all the family! Supersedes all other well known Run menus - B, B+, Master and Tube compatible.
Disk Free Space Display shows the size of all files on a disk and the location of the free space. Touch a key to swap between hex and decimal. Hit 'C' for automatic compact.

ROM CONTROL AND MANAGEMENT

Elegant mode 7 colour display of Rom/Ram sockets showing Rom title and read/write/disable status. Switch Roms off and on - permanently for users of battery backed Ram - even across a power off! (Like the Master Series).
Copy Roms to disk by name or socket number. Transfer any Rom to sideways Ram.
Query read/write/disable status of Rom/Ram sockets.
Handles multiple sideways Ram sockets. Tested with ATPL, Solidisk, Watford and Acorn User Ram extensions.

***DISK FILE INDEXING SYSTEM**

In addition to all the facilities already listed, the BEEBAID Rom is supplied with a Disk File Indexing system. This system automatically maintains an index of all your software and allows you to categorise your programs, eg. Games, Educational, Simulation etc. It can be dynamically tailored to your own requirements, eg. your disk drive configuration and which directories you want to index. The Index may be searched by program name, disk number or category. It is supplied on a 40/80 compatible disk with its own bound manual and it is FREE!

POWER UP OPTIONS

Permanent cure for screen jitter in graphics modes - essential if you've spent a fortune on a monitor! HI-BASIC automatically selected when 6502 second processor active.
Shift key switched for ease of keying lower case BASIC variable names.
Increases the speed of that slow keyboard by 30%! Automatically prevents disks being permanently disabled by some games - no need for power off.

***AND MUCH MORE**

Dump the current text window to the printer with *DTWindow.
Zeroise memory segments using *ERASE commands, including selectable Ram sockets.
Turn the Tube on and off using *TUBEON and *TUBEOFF. Preserves status of text or programs held in second processor.
Relocate any memory segment with *SHIFT.
Relocate any BASIC program with *MOVE.
Disable the Econet system using *NONET.
Load a program to the correct address using *DOWNLOAD.
Enhance your BBC Micro with some 20 additional Break commands.

BEEBAID is fully 6502 second processor compatible and has been tested on model B, B+ 128 and Master Series machines using the Acorn DFS. It has been tested with several sideways Ram boards including ATPL, Watford, Solidisk and Acorn User, using single and multiple Ram sockets. It has also been compatibility tested with many other Roms.

To order your copy of BEEBAID, simply fill in the cutout and send it with a cheque or postal order payable to:

JAYSOFT at: For technical enquiries please call 01-462 8453 (7-9pm)
114 KINGSWAY, WEST WICKHAM, KENT BR4 9JQ

Please send me BEEBAID packages comprising 16K Rom, 40/80 compatible disk and 2 manuals at £34 inclusive. I enclose a cheque/postal order for £

Name

Address

Order despatched by return of post.

LETTERS

MASTERING MANUALS

Sir, Having recently purchased a Master 128 I must say how pleased I was with it. Having upgraded from a Spectrum 48k I was most impressed with the sound, colour, etc. But looking through the adverts in the June edition, I could not find any mention of software for the Master series. Does all the BBC B software work on the Master if I switch to DFS and use the Convert program on the utilities disc? Or will I have to make do with the game on the welcome disc for the rest of the computer's natural life?

Another gripe is the amount of information put into the welcome guide (or rather, not put in there). Just when it looks that it's saying something of great interest, it instead coins the cliché: 'But that is beyond the scope of this guide.' The extremities of this were when introducing *View*, *Viewsheet* and *Editor*. Apparently all the mysteries of the universe (or at least the Beeb Master) are contained in the Reference Manuals, approx £15.00 each. After taking delivery of these two manuals I must say how pleased I was with the information content, even though I found them pretty heavy going at first. The Master seems so much more advanced than the BBC B computer (according to the manuals) but will I ever get to see all the amazing things it can do, in the way of graphics, etc, if I can't get any software for them?

Anyway, all moaning done with, I must congratulate Acorn for a brilliant computer.

David Stevens
Penzance
Cornwall

VERSE AND WORSE

Sir, Help is now at hand for those still wandering about in *Twin*

Kingdom Valley. I have just burst into rhyme to help you.

To get the Bronze Key you must give
The witch an extra eye;
A Palantir – don't try to fight,
Or you will likely die.

Out of the maze you'll find a
dungeon
Dank and cold and grim.
You'll see a guard – a kingly gift
You have to give to him.

Your gift accepted, find yourself
In audience with a king.
His champion you will receive
A periapt, this thing.

Another thing you must acquire
A precious silver key
You'll never have. Your quest
fails if
You see the Princess flee.

To catch her eye she must be
shown
That unto her king you are
known.
Then if you venture back to court,
You will obtain your just reward.

Two ways to cause a dragon's
end:
One is to have a large strong
friend!
The other is a staff of power
Locked within a nearby tower.

So you now dragon slayer be
And in your hand the Master key.
Use it to open every door
To find what you are looking for.

And once you have a treasure
chest
Your answer lieth due south-west.
Near waters meet you'll pass the
test
And find that which is truly best.

Bronze, Silver, Gold and Master
keys,
You should by now have all of
these.
Hard-won bags of silver, gold
And other treasures now be told.

A bucket filled up to the brim,
A chest of gold there at your feet.
You find you have 1k of points –
And yet your task is incomplete!

All of these treasures you will
need
If your great quest is to succeed.
Now look on that which lies
nearby.
That's all, well done, stay cool –
Goodbye!

If you are still stuck, phone 01-
539 7039 between 8pm and 9pm
weekdays and ask for Steve or
Mark.

Stephen Murgan
Leytonstone, London

PRESERVING WORKSPACE

Sir, Re your reply to Clive Brown's letter in July's *Acorn User*, here is a reader about to prove you wrong (as you anticipated!) on the question of a sideways RAM resident disc workspace which would leave PAGE at &0E00.

I have been using MRM Software's E00 DFS for over a year now, and have found it to be very good. It is a small circuit board which plugs into a ROM socket, and contains a DFS Eprom, a 4k RAM chip and a small decoder IC. A lead is connected from the board to the R/W line on the 8271 using a spring clip. It works happily in the basic BBC B or one fitted with a ROM board which will accept sideways RAM, but does not prevent the fitting of such RAM.

The DFS RAM is not corrupted by writes to &8000-&BFFF as it is only enabled when the DFS ROM is selected.

As its name suggests, the DFS leaves PAGE at &0E00; it appears to be functionally identical to Acorn DFS 1.20, and it will run *Elite*, *Dune Rider*, *Doctor Who*, *Hyper Sports*, *Powerplay*, etc, etc. Unfortunately, it will not run *Revs* but will run it if the 4 Tracks disc

is used first! It also works happily with most disc utilities requiring DFS 0.9 or DNFS (DFS 1.20).

I cannot see why a similar idea could not be implemented for the ADFS; the only change would have to be an 8k RAM chip on the board instead of a 4k; this would however map the DFS ROM into &8000-&9FFF and the RAM into &A000-&BFFF, like a 16k Eprom.

Unfortunately, MRM are no longer trading, so it is now up to some enterprising company to produce and market a similar device for the ADFS. Are there any takers out there?

Mike Tomlinson
Wallasey
Merseyside

WHERE ARE ALL THE MASTERS?

Sir, Have Acorn really gone out of business? Are the reports of the Master series just rumours to prevent BBC fans rioting?

I live in the Grimsby area, and I regularly visit the local computer stores. I have yet to see a Master. I have yet to see a BBC B+. In fact, apart from a few Electrons that Dixons and Boots were selling off cheaply, I have not seen an Acorn computer in the shops since before Christmas 1985.

I realise I live in a fairly rural area north of Watford, but civilisation did eventually reach here. I know there is mail order. It would be nice to see before buying, and one hears such horror stories. However, I do use mail order a lot but I wonder for how much longer... And for how much longer will I be able to buy my favourite specialist BBC magazines?

Seriously though, it is my opinion that, if Acorn do not organise their national marketing the way Amstrad/Sinclair seem to do, they stand to lose a lot of business.

Keith M Newborough
North Thoresby
Grimsby

WITH A LITTLE HELP...

Sir, Being a semi-advanced user, who sometimes forgets codes, etc, I was very interested in the Get By With A Little Help article in your July issue. I typed the (rather long) programs in, and entered my help information. However, when I came to delete an entry, I used a disc sector editor as suggested, but found that the formatting of the list printed by *H<RETURN> was wrong. I realised that this was because the routine was printing an extra two spaces around the 'null' entry. The way to cure this is not to use eight nulls, but to use six nulls and two delete characters (ASCII 127 or &7F). This deletes the two extra spaces, and keeps the columns straight. Otherwise the program is excellent.

I have two complaints to make about your magazine; the high score table has had the note 'Please say whether your score was notched up on a BBC micro or Electron... because in future issues we'll be publishing separate tables for each micro' since September '85 (how long can we wait!). And you don't publish enough Basic Checksums, which are useful even in assembler, as they pinpoint the line exactly.

Apart from that, I find the magazine great value for money.

Misha Dorman
Rode, Bath

SHOPPING BY POST

Sir, I read with interest the letter from Maurice Gordon in the July edition of *Acorn User*, and note his sorry experience with mail order firms. I feel that I must comment on behalf of those who have received excellent service from such firms. Although resident in Saudi Arabia, I have had no difficulties in obtaining both software and

hardware from firms in the UK, and in particular must commend Watford for their very prompt replies to all my letters. What minor delays I have experienced have been due to the post, as surface mail takes about three months to reach me from the UK, but in most cases this has been avoided by the use of airmail. I have had clear, intelligent replies to all but one of my postal queries, in dealings with a range of suppliers, and in the one instance where software was advertised before completely ready, I was offered an immediate refund if required, and the cheque was not banked until the package was dispatched.

While I sympathise with Mr Gordon's understandable frustration with dealings from afar, I must say that my experiences have been most satisfactory, and much prefer shopping via the pages of *AU* to that of walking the streets of Bristol, returning home empty-handed yet again. There are always two sides to a story - I would like to think my experiences are in the majority, and I for one will certainly continue to use mail order.

I must finally thank you for a most interesting magazine. It's a welcome read every month out here and, together with my Beeb, gives great pleasure in off-duty moments.

Michael Beattie
Riyadh, Saudi Arabia

UNIVERSITY CHALLENGE

Sir, I have owned a BBC B for almost two years and in those two years I have been a faithful reader of your magazine. I work at the Brussels Free University and do research in the area of computer graphics. With the programs published in your magazine I was able to make some drawings that approached some I made on a Macintosh.

Since the main field of my

research lies in the study of fractals I was glad to find some related articles and programs in your magazine. I have converted the program of your October '85 issue to run on a laser printer and enclosed is a result of that conversion.

I also modified your last program on fractals (May '86) so that it would run with the 16 colours

```

10 REM Mandel 1
20 REM by Dirk De Wolf
30 REM for BBC B/B+/M/E
40 REM (c) Acorn User September 1986
50 :
60 maxcol% = 15
70 MODE 2
80 SX = 255
90 DIM CX(SX), COX(maxcol%, 1)
100 FOR IX = 0 TO maxcol%
110 READ COX(IX, 0), COX(IX, 1)
120 NEXT
130 DATA 0, 0, &11, &22, &33, &33, &32, &31
140 DATA &30, &30, &34, &38, &3C, &3C, &2C
150 DATA &1C, &0C, &03, &0D, &0E, &0F, &0F
160 DATA &0B, &07, &03, &03, &17, &2B, &3F
170 DATA &3F, &2A, &15
180 VDU 2B, 16, &31, 19, 0
190 INPUT "x, y: ", j, k
200 INPUT "  s: ", q
210 var = maxcol% / LOG(SX)
220 FOR NX = 1 TO SX
230 CX(NX) = maxcol% - INT(LOG(NX) * var)
240 NEXT
250 QX = 1024 : MX = 1
260 REPEAT
270 L = q / MX
280 HX = QX / MX
290 FOR JX = 0 TO MX - 1
300 FOR KX = 0 TO MX - 1
310 IF KX MOD 2 OR JX MOD 2 PROCpt
320 NEXT
330 HX = HX * 2
340 PRINT MX
350 UNTIL MX = 256
360 PRINT "END"
370 END
380 :
390 DEF FNm(u, v)
400 NX = -1 : x = 0 : y = 0
410 REPEAT
420 y2 = y * y
430 x2 = x * x
440 y = 2 * x * y + v
450 x = x2 - y2 + u
460 NX = NX + 1
470 UNTIL NX = BX OR x2 + y2 >= 4
480 = NX
490 :
500 DEF PROCpt
510 x = j + L * JX
520 y = k + L * KX
530 YX = JX * HX
540 YX = KX * HX
550 dummy% = FNm(x, y)
560 IX = 0
570 FOR I2X = YX TO YX + HX - 1 STEP 4
580 ? &359 = COX(CX(dummy%), IX)
590 MOVE XX, I2X
600 DRAW XX + HX - 1, I2X
610 IF IX = 0 THEN I2X = 1 ELSE I2X = 0
620 NEXT
630 ENDPROC
    
```

Fractals for a laser printer

mentioned in the article but without the use of a Graphics Extension ROM. The trick is to modify the byte stored at &359. This byte is used by the processor to store the current foreground drawing colour. Since a colour in mode 2 only needs four bits, two colours can be stored in this byte. If you store two different colours in this byte, then generate a draw command, the line will be drawn in mixed pixels of the two colours.

Dirk De Wolf
Aalst
Belgium

WE DON'T MAKE THE RULES

Sir, I am appalled by your blatant display of dual standards.

On one hand you refuse to publish the free ads that mention swapping or selling software. Surely, once purchased, *any* item can be resold or exchanged as second-hand. On the other hand, you publish ads for a Demon modem that is not only 'non-approved' but actually carries a 'prohibited' label. The offer also includes 'free' registration to Microlink. This advert incites people to break the law and risk prosecution.

Acorn User obviously condones the flaunting of the laws relating to equipment being connected to British Telecom lines, and yet will not allow the sale of genuine, though second-hand, software through your pages.

Anthony Howard Jorth
Shipley
Yorks

You are right in saying that items can be resold, but that is not the reason for our ban on swapping software through the free ads page. It came about because ads were being used to swap or sell *copies* of software, which is illegal.

The rules on telecommunications hardware are complex, but the companies you cite were complying with the law, which states that advertisements must say whether the apparatus is approved or not for connection to the BT system. It is legal to advertise 'prohibited' products. It is legal to buy them. It is not legal to connect them to the phone system. This is an example of the law passing the responsibility down the line to the end user.

It might seem a strange system, and it is one which *Acorn User* did not invent, but which we must comply with.

HINTS & TIPS

Martin Phillips continues his review of standard printer codes and explains how screen dumps are programmed

DOWN IN THE DUMPS

To judge from the letters we receive, printers cause more distress and confusion than almost all other problems put together. Many readers have asked for help with screen dumps, so this month I shall show how screen dumps are programmed on dot matrix printers and how they work. Understanding how screen dumps work requires a knowledge of printer commands, as well as a knowledge of how screen images are stored by the computer.

First, what is a screen dump? It's a program that will copy an image of a picture from the screen and dump it to a printer. Usually the foreground colours are printed in black, but it is possible to show each colour as a shade of grey - a tone dump. These are even more complicated than normal screen dumps and, as several have been presented in *Acorn User*, they will not be covered here (see references).

Screen dumps usually work in modes 0-6. Mode 7 screen dumps are possible but work in a totally different way and are outside the scope of this article (see references). A picture screen dump is different from text printing because normally the particular letters, numbers or punctuation marks are each sent as a single code number, which the printer then converts back into the required symbol. The codes follow the ASCII standards. (ASCII stands for American Standard Code for Information Interchange.) They are a standard set of code numbers which relate the various symbols on the keyboard - letters, punctuation marks and numbers - to numbers.

ASCII codes are normally in the range 0 to 255. The ASCII codes from 0 to 31 control the printer's actions, codes from 32 to 127 are used for the letters, numbers and other symbols. Usually codes in the range 128-255 are not used. The VDU summaries in the *User Guides* list the VDU codes in the range 0-31 and 127, and give the ASCII abbreviations. The rest of the ASCII codes can also be found in the *User Guides*, where there are charts showing the ASCII (modes 0-6) displayed character set. The use of these codes explains some peculiarities of the keyboard.

BBC and Master owners will be aware that some keyboard symbols appear differently on the screen in mode 7. The reason is that the

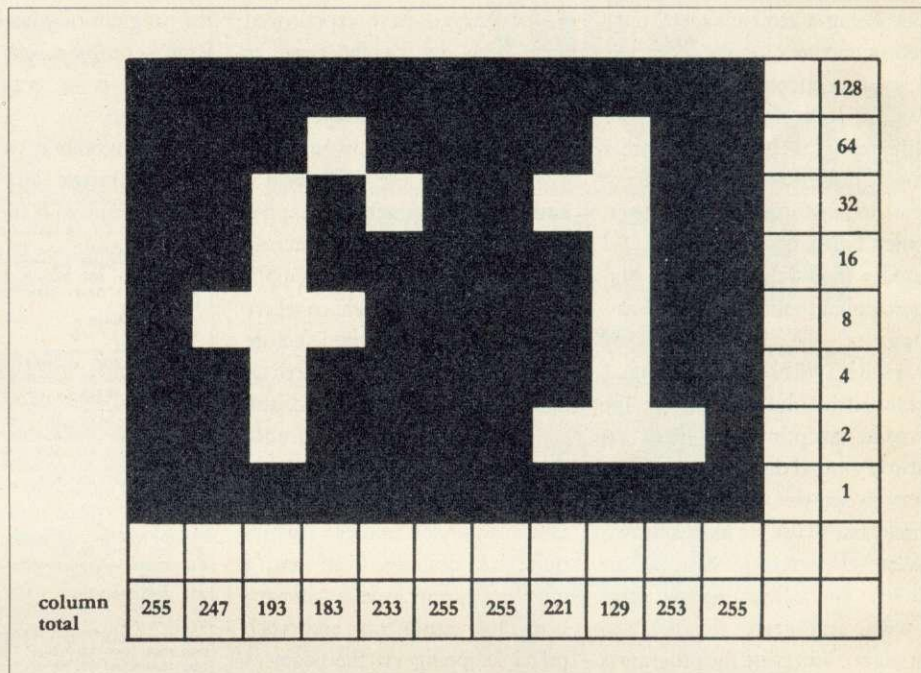

Figure 1. How characters are programmed to be sent to a printer

teletext chip which puts the coded signals on to the screen as recognisable characters does not use the exact ASCII codes, so some symbols appear differently. However, once in any other mode, these codes are interpreted by a different chip inside the computer which does get things right! The same thing can happen with printers too, the pound sign being a common example. Perhaps it should be called AASCII - American Almost Standard Code for Information Interchange.

Before delving into the depths of screen dumps, let's look at how graphics can be sent to the printer. The easiest way to do this is to see how single characters can be programmed and sent to the printer. The idea is to use the 'bit-image' mode. This is actually quite easy, although you'd never realise that from the average printer handbook.

First, draw a grid eight rows high by as many columns as required. In this example I am going to define a special symbol to represent one of the function keys. The symbol is shown in figure 1 and will print an 'f' symbol on a black background. This is similar to the user-defined characters available in BBC Basic except that the number of columns can be any number and not just eight, and the definitions are added up vertically (starting at the bottom) instead of horizontally. Note that the ninth dot wire of the printer is not usually used in bit-

image mode. Some makes of printer handle bit-image mode differently; the early Seikosha printers, for instance, worked from the top down, so that the example given here would appear upside down. It is fairly easy to modify the character definition to put this right. All the programs given here are designed to work on Epson-compatible printers.

The bit-image mode is set by using the ESC K command. This can be found in the printer handbook, usually in a chapter on graphics printing. The Epson FX80 handbook gives the command for this mode of printing as:

```
CHR$(27);"K";CHR$(n1);CHR$(n2);
```

Now that's enough to make anyone give up. Why such a complicated expression? Well, few printer handbooks are written with BBC in mind, and they are normally written in Microsoft Basic, a 'dialect' found on many other computers, but one not as good as BBC Basic. Therefore we have two problems. First to understand what the command is trying to do, and second, how to program that in BBC Basic. The bit image mode of the printer is set using the ESC K code. This translates into BBC Basic as VDU27,75. The number 27 is the ASCII code for the abbreviation ESC, and 75 the ASCII code for K. If you look at the VDU code summary in the *User Guide* you will see that code number 27 does nothing, but its ASCII abbreviation is ESC. The capital letter

K has the ASCII code number 75. (Note that k has a different ASCII code.) An easy way to find the ASCII codes for the various characters is to type a line similar to this:

```
PRINT ASC("K")
```

In this case the number 75 will be given. This does not work with the ASCII control codes in the range 0-31.

A problem with the bit-image mode is that, once it's set, all other codes are translated by the printer as data. Thus it would not be possible ever to switch off this mode. So the code has to be programmed in such a way that it will terminate itself. This is achieved by also including a number which gives the number of bytes of data which will be sent to the printer. The ESC K code has to be followed by two more bytes, which give the number of data bytes which are to be sent. As a large number of data bytes can be sent in the bit-image mode (up to 1920 per line on an 80 column printer), a two-byte number is required. The first byte gives the low part of the number (ie, number of data bytes MOD 256) followed by the high part of the number of bit-image data bytes (ie, number of data bytes DIV 256). Thus to send the character to the printer in bit-image mode, we need to send 11 bits of data. So our code translates to:

```
VDU 27,75,11,0
```

There is just one more thing that needs to be done. These codes need to be sent to the printer only, so we precede each one with a VDU1 code. VDU1 tells the micro to send the next byte to the printer only. Therefore we end up with:

```
VDU 1,27,1,75,1,8,0
```

a pretty far cry from:

```
CHR$(27);"K";CHR$(n1);CHR$(n2);
```

The computer can be used to find the values that you need for n1 and n2 by using the following short program:

```
10 INPUT"Enter number of columns "N
20 PRINT"n1 = ";N MOD 256
30 PRINT"n2 = ";N DIV 256
```

Having defined the symbol and sorted out bit-image mode, we can now get the printer to print out the symbol. Listing 1 in the yellow pages shows how this can be done. The printer is switched on by the VDU2 command, and off by the VDU3 command. The printing of the symbol is done by PROCsymbol. It first sends the bit-image code to the printer, and then sends each of the 11 bytes of data. When the character has been sent to the printer, the printer will return to the text mode and carry on printing normally. If the printer is expecting 11 bytes of data and receives only 10, it will hang up. If it receives more than 11 bytes then the extra bytes will be printed as normal ASCII

symbols, and unexpected symbols will be printed out.

There are several variations on the bit-image mode. Most printers have 'dual density bit-image', and 'quadruple density bit-image' modes. Dual density symbols can also be drawn and these give a better print quality. This is printer code ESC L. Because each vertical row of dots overlaps the previous one, twice as many columns need to be sent. Listing 2 shows how this is done. The number of bytes sent is changed in line 150 to 22, and each column of data is repeated twice. A similar set of changes would need to be made for quadruple-density, although there is little improvement in quality.

Bit-image mode is not really too difficult. It is also quite easy to extend the ideas to a full screen dump. First we need to know how the computer's pictures are put on the screen. The graphics screen is based on a grid of 1280 dots across, 1024 dots up. The BBC does not work to this resolution, however, as the following chart shows.

Mode	Horizontal resolution	Vertical resolution
0	640	256
1	320	256
2	160	256
4	320	256
5	160	256

In all modes the vertical resolution is 256, but the horizontal resolution varies between 160 and 640. Screen dumps are slow, because they have to test each point on the screen and send that information to the printer. In mode 0 this requires testing 640 x 256 bits of information - 163,840 bits altogether.

The first consideration is the mode size, with the number of dots to be printed. The normal density bit-image mode gives 60 dots to the inch. On paper which is normally just over 8in wide, this gives a maximum of 480 dots per line. This is fine for modes 1, 2, 4 and 5 where there are 320 dots per line, but in mode 0, with 640 dots across, there is not enough room. Here double density bit-image mode is useful, as this allows up to 960 dots per line. Listings 3 and 4 show the two appropriate variations on the screen dumps. In each listing PROCcircle is a routine to draw a series of circles on the screen which are then dumped to the printer.

The dumps work in a similar manner to the symbols printed by listings 1 and 2, except that this time the screen is scanned using the POINT statement to determine which pixels are not in the background colour. In listing 3,

the screen is scanned in a 320 x 256 grid, and in listing 4 in a 640 x 256 grid. The inner y% loop is used to build up the printer byte column, which is held in the variable D%. Integer variables have been used to speed up the screen dumps. They can be speeded up more by

The references to X%, Y% and y% relate to those variables in listings 3 and 4.

Line 330: Switch on printer

Line 340: Set maximum Y% value to 1023

Lines 350-

360: Set line spacing to 8/72 inch

Line 370: Start new line. Set X% to 0

Line 380-

390: Send bit-image command (line length 320 or 640)

Line 400: Start new y% column

Line 410: Perform equivalent of POINT

Lines 420-430: Check POINT and increment byte if above 0 (Change BEQ to BNE for inverse dump)

Lines 440-460- Subtract 4 from Y% and check column end

Lines 470-480: Send byte to printer and increase X% value

Lines 490-520: Check for end of line (X > 1279)

Lines 530-540: Reset printer and disable it

Line 550: : Subroutine to send bytes to printer preceded by VDU 1. Accumulator value put on stack until VDU 1 has been sent

Description of listings 5 and 6

leaving out the variable after each NEXT. At the start of each line, the bit-image code is sent to the printer, and at the end of each line the new line code is sent. This is the VDU1,10. If your printer does not go on a new line with this dump then either change this line to read VDU1,10,1,13 or alter the printer 'dip switch' which gives a line feed to the 'on' position. Details of these dip switches can be found in your printer handbook.

Listings 3 and 4 can easily be changed so that they produce an inverse print, that is white lines on a black background. All that needs to be changed is line 340 in either listing to read:

```
340 IF POINT (X%,Y% - y%*4) = 0 THEN D% = D% + 1.
```

Similarly, it is possible to dump any colour combinations by changing that line. Thus to dump any red graphics in mode 1 line 340 would need to be changed to:

```
340 IF POINT (X%,Y% - y%*4) = 1 THEN D% = D% + 1
```

HINTS & TIPS

Codes	Effects	Amstrad DMP2000	Kaga 810	Olivetti PR15-B	Olivetti Inkjet JP101	OKI Microline 192/193	BMC	Smith- Corona D100	Smith- Corona D200/D300
8	Backspace	●	●	●			●	●	●
12	Form feed (new page)	●	●	●	●	●		●	●
13	Carriage return	●	●	●	●	●	●	●	●
14	Double width, 1 line only	●	●	●		●	●	●	●
20	Cancel double width, 1 line only	●	●	●		●	●	●	●
15	Condensed mode	●	●	●		●	●	●	●
18	Cancel condensed mode	●	●	●		●	●	●	●
27,45,1	Underline mode	●	●	●	27,42	●	●	●	●
27,45,0	Cancel underline	●	●	●	27,43	●	●	●	●
27,48	Spacing 1/8"	●	●	●	27,69	●	●	●	●
27,49	Spacing 7/72"	●	●	●	27,70	●	●	●	●
27,50	Spacing 1/6"	●	●	●			●	●	●
27,52	Italics	●	●			27,37,75	●	●	●
27,53	Cancel italics	●	●			27,37,72	●	●	●
27,56	End of paper detect off	●	●	●		●	●	●	●
27,57	End of paper detect on	●	●	●		●	●	●	●
27,64	Initialise printer (reset)	●	●	●	27,48		●	●	●
27,69	Emphasised printing	●	●	●		●	●	●	●
27,70	Cancel emphasised printing	●	●	●		●	●	●	●
27,71	Double-strike mode setting	●	●	●		●	●	●	●
27,72	Cancel double-strike mode	●	●	●		●	●	●	●
27,77	Elite mode	●	●	●				●	●
27,78,n	Skip-over perforation setting	●	●	●		●	●	●	●
27,79	Cancel skip-over	●	●	●		●	●	●	●
27,80	Pica mode	●	●	●				●	●
27,82,x	Int. character set English x = Int. character set American x =	● ¹	● ¹		27,91	27,33,n		0 2	0 2
27,83,0	Superscript on	●	●	●		●	●	●	●
27,84	Superscript off	●	●	●		●	●	●	●
27,83,1	Subscript on	●	●	●		●	●	●	●
27,84	Subscript off	●	●	●		●	●	●	●
27,87,1	Double width	●	●	●	27,51	●	●	●	●
27,87,0	Cancel double width	●	●	●	27,52	●	●	●	●
27,97,n	Justify text (n=0-3)								
27,104	Set double height				27,39				
27,117	Cancel double height				27,37				
27,106,n	Reverse feed n/216"	●	●					●	●
27,112,1	Proportional print	●	●						
27,112,0	Proportional print cancel	●	●						
27,114	Reverse print on								
27,116	Reverse print off								
27,120,1	Near letter quality on	●	27,40	27,52		27,73,3			27,59
27,120,0	Near letter quality off	●		27,53		27,73,1			27,59
Graphics commands:									
27,65,n	Line spacing n/72"		●	●		●	●	●	●
27,75	Normal density bit image mode	●	●	●	27,71 ²	●	●	●	●
27,76	Dual density bit image mode	●	●	●		●	●	●	●
27,89	Double density bit image mode	●	●	●		●		●	●
27,90	Quad density bit image mode	●	●	●		●		●	●
27,42,n	Select bit image mode	● ¹	● ¹	● ¹				n=0-5	n=0-5

Notes: ¹No more information available. ²Uses different code sequence

Standard printer codes for another eight printers

These screen dumps are painfully slow, and an appreciable saving in time is gained by using machine code. The technique for a machine code screen dump is exactly the same as for a Basic screen dump. The biggest problem with a machine code dump is the lack of the convenient Basic FOR . . . NEXT loop. An OSWORD call has to be made, equivalent to the Basic POINT routine when an accumulator parameter of 9 is used. The OSWRCH routine is the operating system equivalent of the VDU call.

One problem with the screen dumps so far is that they do not produce round circles. The reason for this is that printers print with a vertical spacing of 72 dots to the inch, and with a horizontal spacing of 60 dots to the inch. Thus the circles appear as ellipses. Some printers now include another graphics command. This is the ESC * code, which will allow several graphics variations. Epson printers have seven variations; some printers, including the Citizen 120D, have eight. This code, with a parameter of five, allows graphics with 72 dots to the inch to be produced, thereby offering true circles. The changes that need to be made to listing 5 are:

```
380 LDA #27:JSR printer:LDA #42:JSR printer:LDA #5: JSR printer
```

For those who have a printer like the Citizen 120D which has eight variations, the last one will produce a dual-density proportional screen dump. This can then be used with the mode 0 screen dump. The following changes need to be made to listing 6:

```
380 LDA #27:JSR printer:LDA #42:JSR printer:LDA #7: JSR printer
```

Note that this will not work on many printers.

Once a machine code dump has been made to work, it can be saved as it stands, and also the machine code element can be saved on its own. To do this, run the program and when it has finished type:

```
*SAVE SDUMP 900 +FF
```

and the machine code part will be saved to cassette or disc with the filename SDUMP. It has been located at &900, usually quite a safe area of memory, but other locations could be used. To use the screen dump from within programs, several options are possible:

1 Include the assembler procedure in the listing and run it at the start of the program. Then call it up as in listings 5 and 6.

2 Load in just the machine code element at the start of the program by including a line such as:

```
*LOAD SDUMP
```

and then call it up as required.

3 Disc users can load in and run the dump by including the line

```
*SDUMP
```

at the appropriate point in a program. The machine code dump must be on the program disc, and, of course, the disc will have to be kept in the disc drive while the program is running. This technique is very useful if memory space is a problem.

A final point on the note of screen dumps. The graphics origin must be set at 0,0 to produce a full screen graphics dump. Otherwise the dump will include areas that are off the screen and these will be printed in black.

QUICKFIRE QUESTIONS

Staying on the subject of printers, this month's quick hints are all connected with printers.

- Do get the printer paper thickness setting correct. This is a small lever at one side of the roller. It gives a blacker print and makes the printer run more quietly with less wear.

- Having set the dip switches on the printer, do not change them when a new effect is required. These switches are not designed for frequent use, and will soon become unreliable. Use software commands instead.

- Having trouble loading fanfold paper? Load it in at the first fold with the paper doubled-up.

- Do the descenders (the tails on the ys and gs, etc) on your printer look faint? This is because with infrequent use they tend to get gummed up and stick. Free them off by printing a few lines of gs or ys - eg, enter the following line:

```
VDU2:FOR N=1 TO 5000:P."y";;
```

```
NEXT:VDU3
```

STANDARD PRINTER CODES

In January's Hints and Tips I asked for help to produce a comparison chart of printer codes for a whole range of printers. This was to make it possible to see at a glance which codes are standard and which are not.

The codes for the first 10 printers were published last month and this month eight more are included (see table 1, opposite). The codes published are those which are generally the most useful; they do not represent the total list of codes.

For instance, the printer tab commands have not been included as a wordprocessor can do just as well by adding spaces or using Tab, without having to resort to these specialist printer commands, and few if any programs need to make use of them.

FURTHER READING FROM ACORN USER

Here is an index of printer dump articles and listings published in *AU* over the last three years

	Issue	Page
All-mode dump	Dec 83	53
Assembler versions	Sep 83	57
Automatic	Aug 83	72
Canon PJ1080A	Jul 84	XIV
Centronics 737/9	Sep 84	127
Centronics 739	Aug 83	67, 101
Colour	Jul 84	167, XII
Daisywheel printers	Jun 84	146
Epson-compatibles	Jan 86	48
Epson printers	Mar 84	45
Epson JX70	Oct 85	167
Fastext 80	Mar 85	167
Juki 6100	Jan 84	130
Mode 0	Sep 84	99
Mode 7	Feb 85	119
Olivetti Spark-jet	Aug 83	65, 72
OS 0.1 vs OS 1.2	Oct 83	101
'Protected' screens	Dec 84	86
Sanpole printer	Jun 84	146
Seikosha AP100	Aug 83	22,72
Seikosha AP100	Sep 83	61
Seikosha GP250	Apr 84	174
Seikosha GP250	Jun 84	II
Star printers	Mar 84	34
Tandy CGP115 plotter	Aug 83	85
Teletext and mode 7	Mar 84	34
Teletext and mode 7	Apr 84	77
User-defined characters	Dec 85	49
User-defined characters	Apr 86	50
User-defined characters	May 86	85
View printer driver	Jun 85	137
Wordwise for Epson	Aug 84	51

QUINN'S QUICKIE

Many readers have written to us with comments on the reviews of Mirrorsoft's *Fleet St Editor* and the AMX *Pagemaker* in the May and June issues. To clarify one of the major points, none of the pictures in the *Pagemaker* review, and just two in the *Fleet St* review were supplied with the package.

The cartoon figures of Willy Whitelaw, Leon Brittan, Flook, Jane and Spiderman were done by tracing enlarged photocopies of the originals on to a clear plastic bag with a ballpoint pen.

The tracing was then stuck on the monitor and used as a guide when drawing from scratch. Days of pixel-editing did the rest!

FIRST BYTE

MACHINE CODE MADE EASY

The second of two articles on machine code programming:
how to combine Basic in your programs

Tessie Revivis

Writing long programs in machine code can be quite time-consuming. Many software houses first write their programs in Basic to work out the logistics before translating the software into machine code. In many cases a first-rate compromise can be made by combining machine code and Basic – the main framework of the program is written in Basic and then the sections that need to work fast (typically animation or moving large areas of memory) can be translated into assembler, with the

1	1	0	0	0	0	1	1
1	0	0	0	0	1	1	0
0	0	0	0	1	1	0	0
0	0	0	1	1	0	0	0
0	1	1	0	0	0	0	0
1	1	0	0	0	0	0	0
1	0	0	0	0	0	0	0
0	0	0	0	0	0	0	0

Figure 1. Bits on the move

code via the integer variable A%. Because the accumulator can only hold numbers in the range 0-255 the value of A% should also be kept in this range. Attempts to pass higher values will not work as expected. The variables X% and Y% may also be used to pass values to the X and Y registers in the same fashion. Thus values may be seeded into these registers from Basic very easily. The example in listing 1 is very simple and does nothing spectacular, other than clearly demonstrating the point.

Listing 2, on the other hand, is much more interesting; a good way of ending a screen display is to make it wither away – which *Repton* does to good effect. It seems complicated at first but with some knowledge it can be written in just 27 bytes of machine code. Listing 2 contains several mnemonics which we have not yet discussed but that should not stop you from entering and running the program to see the effect. Briefly, what is happening is that the machine code is accessing every byte on the screen (and there are 20480 in all!) and shifting the 8 bits which make up the byte along by 1 bit at a time to the left so that the left-most bit falls off. The empty right-most bit is replaced with a zero – which shows up as black on the screen. Figure 1 shows how this works – if you follow the two 1s on the right, they shift to the left and appear to work their way through the byte, falling out on the left-hand side after eight shifts to the left.

This type of shift is known as an Arithmetic Shift Left which has the mnemonic ASL in assembly language. Why arithmetic? The answer is because it undertakes a fundamental

mathematical operation – shifting the bits to the left by one position effectively doubles the byte's value! To understand how this works requires a knowledge of binary representation – the Jan 86 issue of *AU* had a description of this on page 61 so look there if you need the detailed explanation. In summary, though, each bit position is greater than the first by a power of 2, so the left-most bit has the value $2^0=1$, the next bit the value $2^1=2$, the next bit $2^2=4$ and so on up to the eighth bit which has the value $2^7=128$ ($2*2*2*2*2*2*2$). The binary value 0000011 breaks down to 2^1+2^0 which simplifies to $2+1=3$. Shifting left by one position gives 00000110 which is $4+2=6$.

The operation which complements ASL is LSR – Logical Shift Right. This halves the value of the byte in question – you might like to try to adapt listing 2 to 'wither' the picture off screen in the opposite direction.

Two-pass assembler

The assembler in the BBC micro and Electron is referred to as a two-pass assembler – because it's often necessary to assemble a program twice by enclosing it within a FOR . . . NEXT loop, as we did in listing 2. The reason can be found by studying listing 2 and referring back to listing 2 of last month's First Byte. There we defined a label that could be jumped to by the program, thereby enabling it to loop, rather like this segment of an assembly language program:

```
100 .start
110 TYA
120 JSR &FFEE
130 INY
140 CYP #ASC"Z"
150 BNE start
```

When the program is run the assembler assigns an address to the label 'start' – when it reaches line 150 it can calculate just where the program needs to jump back to. However, consider the following segment:

```
100 CPY #ASC"Y"
110 BNE end
120 TYA
130 JSR &FFEE
```

```
10 REM First Byte - listing 1
20 REM Passing values
30 REM by Tessie Revivis
40 REM for BBC B/B+/M/E
50 REM (c) Acorn User September 1986
60 :
70 DIM code% 255
80 PROCass
90 PRINT "Press any key"
100 key%=GET
110 FOR loop%=ASC"A" TO ASC"z"
120 A%=loop%
130 CALL code%
140 NEXT loop%
150 END
160 :
170 DEF PROCass
180 P%=code%
190 [
200 JSR &FFEE
210 RTS
220 ]
230 ENDPROC
```

Listing 1. Program to print the alphabet

machine code being called at the appropriate points within the program. Some examples will make this clearer.

Listing 1 is similar to that published last month in that it will print the alphabet. However, unlike the earlier program, the control loop used to move from the letter A to the letter Z is written as a FOR . . . NEXT loop in Basic. The machine code assembled by PROCass simply prints the current letter, and this is called from within the FOR . . . NEXT loop. The current letter, defined by the ASCII code held in loop% is passed into the machine

```

10 REM First Byte - listing 4
20 REM Memory Mover
30 REM by Tessie Reviviss
40 REM for BBC B/B+/M/E
50 REM (c) Acorn User September 1986
60 :
70 DIM code% 255
80 bytes=&70
90 end=&72
100 start=&74
110 S%=&3000:E%=&5800:L%=&2000
120 MODE 1
130 :
140 REM Basic Version
150 PROCscreen(12,27,"Basic Version")
160 PROCw(3,16,37,13,1,2)
170 PROCc(14,"Please press any key")
180 key%=GET
190 FOR loop%=0 TO L% STEP 4
200 !(E%+loop%)=(S%+loop%)
210 NEXT
220 :
230 REM Machine Code Version
240 PROCscreen(9,30,"Machine Code Version")
250 PROCw(3,16,37,13,1,2)
260 PROCc(14,"Please press any key")
270 key%=GET
280 !bytes=L%
290 !end=E%
300 !start=S%
310 PROCass
320 CALL memmove
330 A=GET
340 RUN
350 END
360 :
370 DEF PROCass
380 FOR pass=0 TO 2 STEP 2
390 P%=code%
400 [
410 OPT pass
420 .memmove
430 SEC
440 LDA end
450 SBC start
460 TAX
470 LDA end+1
480 SBC start+1
490 TAY
500 TXA
510 CMP bytes
520 TYA
530 SBC bytes+1
540 BCS moveleft
550 BCC moveright
560 .moveleft
570 LDY #0
580 LDX bytes+1
590 BEQ lpartpage
600 .leftpagess
610 LDA (start),Y
620 STA (end),Y
630 INY
640 BNE leftpagess
650 INC start+1
660 INC end+1
670 DEX
680 BNE leftpagess
690 .lpartpage
700 LDX bytes
710 BEQ exit
720 .lastleft
730 LDA (start),Y
740 STA (end),Y
750 INY
760 DEX
770 BNE lastleft
780 .exit
790 RTS
800 :
810 .moveright
820 CLC
830 LDA bytes+1
840 PHA
850 ADC start+1
860 STA start+1
870 CLC
880 PLA
890 ADC end+1
900 STA end+1
910 LDY bytes
920 BEQ rightpages
930 .transfer
940 DEY
950 LDA (start),Y
960 STA (end),Y
970 CPY #0
980 BNE transfer
990 .rightpages
1000 LDX bytes+1
1010 BEQ exit
1020 .update
1030 DEC start+1
1040 DEC end+1
1050 .page
1060 DEY
1070 LDA (start),Y
1080 STA (end),Y
1090 CPY#0
1100 BNE page
1110 DEX
1120 BNE update
1130 RTS
1140 ]
1150 NEXT
1160 ENDPROC
1170 :
1180 DEF PROCscreen(lf%,rt%,A%)
1190 VDU 23,1,0;0;0;0;0;
1200 COLOUR 129:CLS
1210 PROCw(3,5,37,2,1,2)
1220 PROCc(3,"Acorn User's Memory Mover")
1230 PROCw(lf%,11,rt%,8,1,2)
1240 PROCc(9,A%)
1250 ENDPROC
1260 :
1270 DEFPROCc(y,t%)
1280 VDU 26,31,20-LENT%/2,y
1290 LOCAL w:w=&70
1300 FOR z=1 TO LEN t%
1310 ?w=ASC MID$(t%,z,1)
1320 A%=&A:X%=&70:Y%&0:CALL &FFF1
1330 VDU 23,224,w?1,w!1;w!2;w!3;w?4,23,225,w?5,w!5;w!6;w!7;w?8,224,8,10,225,11
1340 NEXT
1350 ENDPROC
1360 :
1370 DEFPROCw(l,d,r,u,p,q)
1380 VDU 24,1*32-16;(31-d)*32-16;(r+1)*32-16;(32-u)*32-16;18;131,16,24,1*32-12;(31-d)*32-12;(r+1)*32-20;(32-u)*32-20;18;128,16
1390 COLOUR p:COLOUR 128+q
1400 VDU 28,1,d,r,u,12
1410 ENDPROC

```

Listing 4. Moving blocks of memory, first using Basic, then machine code

```

140 INY
150 .end

```

Now when line 110 is reached, the program will have no idea where 'end' is (as it has not yet encountered it) and so an error will occur. In two-pass assembly the first pass is used by the assembler to find out just where all the labels are and to assign addresses to them; in the second pass the assembler has access to a table of these addresses which it can then assign to the instructions that require them.

Look again at listing 2 and you can see how the two passes are implemented. What is not

immediately obvious is why the particular step size is used (line 380). The answer lies in the assembler pseudo-mnemonic called OPT. This controls the way in which your assembler carries out the two-pass assembly - there are three different ways which are summarised in table 1 on page 57.

The loop used in the listing suppresses errors in the first pass (vital, otherwise an unrecognised label would cause an error) and allows them during the second pass (again vital as you may actually have an error!). The use of an OPT value of 2 during the second pass also

suppresses the assembler data listing being displayed on the screen - try changing the two 2s in line 170 to 3s:

```

380 FOR pass%=0 TO 3 STEP 3

```

and you will see an assembly data listing displayed when you run the program. The only other important point to remember in two-pass assembly is that the value assigned to P% takes place within the loop. This is so that the code is assembled in the correct position during the second pass and not on the end of the first erroneous piece of machine code, which would otherwise be the case.

EPROMS, 8271

(Phone for quantity discounts)

	Ex VAT	Inc VAT
1-9 27128 Hitachi 250nS Eprom	2.57	2.95
10 + 27128 Hitachi 250nS Eprom	2.30	2.65
2764 Hitachi 250nS Eprom	2.00	2.30
27256 Hitachi 250nS Eprom	4.57	5.25
1-9 6264LP-15 8K x 8bit Ram	3.04	3.50
10 + 6264LP-15 8K x 8bit Ram	2.57	2.95
1-9 8271 Floppy Controller	32.17	37.00
10 + 8271 Floppy Controller	30.43	35.00
1-9 Disc CMOS/TTL chips	4.77	5.49
10 + Disc CMOS/TTL chips	4.00	4.60
Acorn 8271 DFS Disc Interface	42.61	49.00
Acorn 8271 DNFS Disc Interface	51.30	59.00
1-9 B Plus 64K to 128K Upgrade	26.00	29.90
10 + B Plus 64K to 128K Upgrade	22.00	25.30
Inter-Sheet (Spreadsheet)	39.00	44.85
Inter-Word	39.00	44.85
Basic II Rom for BBC Micro	13.00	14.95
View	36.52	42.00
ViewStore	36.52	42.00
Wordwise Plus Rom - Computer Concepts	39.09	44.95

(Full range of Roms available)

Recall & Printer Buffer Sideways RAM Utility

Suitable for Master & BBC B with sideways ram. Allows recall and editing of the last 20 Commands and a 8k to 12k printer buffer. £14.95 (£13.00 + VAT)

View Printer Driver

Provides additional facilities NLQ on/off etc. Please state which printer: KP810, PW1080A, LX80, 120D, NL10, 5510, FX85 £9.95 (£8.65)

DISC DRIVES - SPECIAL OFFER

	Ex VAT	Inc VAT
Mitsubishi 400k Drive & Acorn Disc Interface	138.26	159.00
Cumana 3.5" 100k CSX351 Disc Drive	42.61	49.00
Akhter 400k 80 track MD400A Disc Drive	100.00	115.00

DISKETTES (Lifetime warranty)

	Ex VAT	Inc VAT
10 96tpi D/S D/D in library case	13.90	15.99
10 Low cost 96tpi D/S D/D in library case	7.39	8.50

MASTER SERIES

	Ex VAT	Inc VAT
Master 128K Micro	395.00	454.25
Master Dust Cover	3.00	3.45
Master Turbo Upgrade	103.48	119.00
Master Econet Module	43.47	49.99
Reference Manuals (each)	14.95	14.95

TAXAN

with BBC cable & paper
£239.00 (207.83 + VAT)



KAGA KP810

	Ex VAT	Inc VAT
KP910 17" width printer	328.70	378.00
KP810 Paper roll	3.43	3.95
KP810 Dust Cover	4.00	4.60
KP810 Print ribbon	4.80	5.52
KP810 Printer Control/Dump Rom	13.00	14.95
Fontaid (NLQ Designer)	26.00	29.90

Citizen 120D

with BBC cable & paper
£165.00 (143.48 + VAT)

Juki 5510

with BBC cable & paper
£219.00 (190.43 + VAT)

Juki 6100

with BBC cable & paper
£239.00 (207.83 + VAT)

Juki 2200

with BBC cable & paper
£269.00 (233.91 + VAT)

Epson LX80

with BBC cable & paper
£218.50 (190.00 + VAT)

Star NL10

with BBC cable & paper
£236.90 (206.00 + VAT)

	Ex VAT	Inc VAT
LX-80 Tractor Unit	18.22	20.95
LX-80 Sheet Feeder	47.83	55.00
LX-80 Dust Cover	4.00	4.60
LX-80 Print Ribbon	3.90	4.49
LX-80 Printer Control/Dump Rom	13.00	14.95

Phone for our best price before placing your order

EDUCATIONAL & GOVERNMENT ORDERS WELCOME

All products have a 12 month no quibble guarantee

We are closed all day Wednesday and Saturday afternoon

Prices subject to variation without prior notification

Carriage 92p (80p + VAT) Securicor £6.90 (£6.00 + VAT)

WeServe

Acorn Dept,
128 West Street,
Portchester,
Hants.
PO16 9XE.
Tel: 0705 325354



NEXT DAY DELIVERY
BY SECURICOR



NEW HIGH RESOLUTION TV/MONITOR

TINTED GLASS FRONT

36cm SQUARE DISPLAY

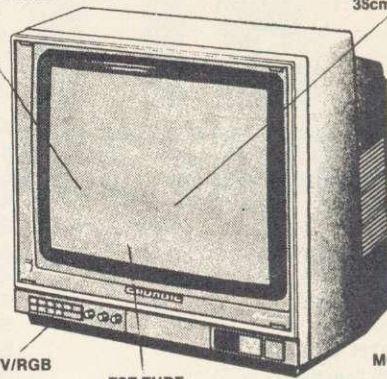

INTEGRATED TV/RGB
SWITCHING

FST TUBE

MONITOR STYLING

Flat square tubes are made for high quality picture performance. Why not consider one?

The '15"' P40 range has:-

★ 36cm Flat Square display Tube.

★ 0.5mm Stripe pitch for high resolution.

★ 3 way operation:-

1. High resolution TV, 2. Composite Video and Audio, 3. RGB (and Audio)

★ Integrated switching & level control.

★ RGB Contrast & Brightness

★ Automatic colour balance for long term stability

★ Other sizes are '21"' P55 range, '24"' T63 and the high quality '28"' M70 which is ideal for group viewing.

A high quality advanced design **GRUNDIG TELEVISION** Modified only by **NEWARK VIDEO CENTRE** for the BBC Computer.

Manual set (P40125) £275.00. Remote control (P40245) £299.95. With teletext (P40245TT) £359.00. Prices include carr. & VAT. BBC Leads £5.99.

Callers welcome to see for themselves at:-

NEWARK VIDEO CENTRE

108 London Rd, Balderton, Newark, Notts

Tel: 0636 71475

Mon-Sat 9am-5.30pm for ACCESS/VISA Telesales

AA276

VIEW SUPERDRIVERS . . . drive your printer to its limits.

- * Proportional spacing with justified right margin
- * Change daisywheel in mid line
- * Access **any** control code or escape sequence from View
- * Suitable for Brother HR15, Juki 6100, Quendata 1120 and many others
- * We also sell daisywheels . . . lots of them

Send now for details

IO Computer Communications

7 Great George Street

Glasgow G12 8PD

041-339 5481

AA275

3" HITACHI DISK DRIVES

Suitable for use on the Amstrad 6128, 664, Tatung Einstein, BBC with DFS. 40 track, double density. 3 ms track access time. Unformatted capacity — single sided 250k; double sided 500k. Shuggart interface. Plug compatible with 5/4 inch drives.

PRICE:
£29.95 + VAT
Single sided
£39.95 + VAT
Double sided



Cables available for connection to:
Amstrad — £7.50 plus VAT
BBC — £10.00 plus VAT.
Tatung — £10.00 plus VAT.

FOR FURTHER DETAILS SEND S.A.E. TO:

MATMOS Ltd., Unit 11, Lindfield Enterprise
Park, Lewes Road, LINDFIELD,
West Sussex. RH16 2LX. Tel. 0444-73830

Or Computer Appreciation,
111 Northgate, CANTERBURY, Kent. CT1 1BH.

- 0 Assembler errors suppressed, no listing.
- 1 Assembler errors suppressed, listing.
- 2 Assembler errors reported, no list.
- 3 Assembler errors reported, listing.

Table 1. Summary of OPT values

Addressed up

Look at any assembly program and you will notice that many of the mnemonics it contains are similar but the operand can take a different format (see last month's article). This format is called the addressing mode. Listing 3, when run, will print the letter p on the screen – the ASCII code for the letter p is loaded into the accumulator in line 110. Because the action is done immediately by the machine code, the address-

```

10 REM First Byte - lis
ting 3
20 REM Print a 'p'
30 REM by Tessie Revivi
S
40 REM for BBC B/B+/M/E
50 REM (c) Acorn User S
eptember 1986
60 :
70 DIM code% 20
80 oswrch=&FFEE
90 P%=code%
100 [
110 LDA #&70
120 JSR oswrch
130 RTS
140 ]
150 PRINT ' '
160 CALL code%
```

Listing 3. Immediate addressing at line 110

ing mode is known as immediate addressing – the ASCII data is immediately after the opcode in the operand. The immediacy is implied by the hash after the mnemonic. Now change line 110 so that the hash is deleted:

```
110 LDA &70
```

and re-run the program – the result will be random because we have now changed the addressing mode so that the accumulator is loaded with the contents of the location &70 – the operand is no longer treated as the immediate data byte but rather the address where the data is stored. Type:

```
?&70=&70
```

Location &70 with zero page now contains the ASCII code for p; if you re-run the program a p will be printed. Poking any value into &70 will result in the value being displayed as an ASCII character. As an exercise try writing a program using this technique to print the alphabet backwards. Because the data is stored in zero page this type of addressing is known as zero page addressing.

The next question is how does the machine

```

10 REM First Byte - lis
ting 2
20 REM Withering Screen
30 REM by Tessie Revivi
S
40 REM for BBC B/B+/M/E
50 REM (c) Acorn User S
eptember 1986
60 :
70 MODE 1
80 DIM code% 500
90 count=&70
100 PROCass
110 PRINT"Press a key...
"
120 any=GET
130 REM Insert MODE x fo
r mode required
140 REM Insert *LOAD <sc
reen name>
150 CALL shift
160 END
170 :
180 DEF PROCass
190 FOR pass%=0 TO 2 STE
P 2
200 P%=code%
210 [
220 OPT pass%
230 .shift
240 LDY #8
250 .shiftloop
260 LDA #&33
270 STA addr+2
280 LDX #0
290 .addr
300 ASL &3000,X
310 INX
320 BNE addr
330 INC addr+2
340 BPL addr
350 DEY
360 BNE shiftloop
370 RTS
380 ]
390 NEXT pass%
400 ENDPROC
```

Listing 2. Two-pass assembler at work

code know which addressing mode is being used when it comes to interpret the opcode. The answer is in the opcode. When the assembly language program is run the assembler generates an opcode which also distinguishes the addressing mode. If you re-run both versions of listing 3 and look at the assembly data you will see that the opcodes for LDA# and LDA are different from one another: &A9 for immediate addressing and &A5 for zero page addressing.

The addressing mode is not limited to just the LDA mnemonic. In fact most mnemonics, though not all, will allow some if not all addressing modes to be used. Another type of addressing mode is 'absolute addressing'. Here, absolute means a two byte address, ie &7C00 is an absolute address. With second processor and shadow memory switched off (if you have them) you can write directly to the

screen memory. Make the following changes to listing 3:

```

110 LDA #&33
120 STA &7C00
150 MODE 6
```

When you run the program now, you will notice that two small lines will have appeared roughly in the centre, two-thirds of the way down the screen. To understand why we have two lines, look at the bit pattern for &33 – 00110011. A 1 shows up as a white dot and a 0 as a black dot – thus we have two sets of two dots, which appear as short lines.

Addressing modes are therefore important – the 6502 has a basic set of 55 mnemonics, but the use of different addressing modes effectively extends this to 152 different operations.

On the move

The final program presented this month (listing 4) is both a good demonstration of the speed at which machine code runs and also provides a useful routine which you might like to try to incorporate into your own Basic programs – particularly those involving animation. Simply, it can intelligently move large blocks of memory. When run the program displays a simple mode 1 screen with some text windows; the top section of this screen is then copied to the lower half in Basic, though rather slowly. When this is complete it does the whole thing again, but this time uses a machine code move routine in the bat of an eyelid. Note that this program, like listing 2, accesses the screen directly – so make sure that you turn any Shadow RAM or second processor off before you enter it.

The program is simple to use because it requires just three pieces of information: the start address of the area of memory to be moved (S%), the destination 'end' address (E%), and the length in bytes of the memory block to be moved (L%). These variables are set in line 110 of the program.

The last two months should have shown just how easy it is to use assembler. Even if you have not used it before, you do not have to be an expert to type in assembler listings from magazines such as *AU* or from books. Do experiment with the listings presented on these pages by incorporating them into your own programs.

We have only scratched on the surface of the subject – it is a large one – and I will be returning to it on a more regular basis. In the meantime why not buy a book on the subject or borrow one from your library and have a bash at getting into assembler. A personal recommendation would be *Mastering Assembly Language* published by BBC Publications.

Watford Electronics

Jessa House, 250 Lower High Street, Watford WD1 2AN, England

Tel: Watford (0923) 37774/40588 Telex: 8956095 WATFRD

Credit Card Orders (ACCESS & VISA) Tel: (0923) 33383 or 50234 (24 Hours)

All prices exclusive of VAT; subject to change without notice & available on request.



BBC MASTER 128K Micro	£395
BBC MASTER TURBO 4MHz	£510
512K Add on Board	£335
TURBO Add-on Module	£99
BBC MASTER ET (Econet Terminal)	£320
Econet Module for the Master	£43
ROM Cartridges for Master	£13
Reference Manual I (No VAT)	£15
Reference Manual II (No VAT)	£15
Advance Ref. Manual (No VAT)	£19
64K Upgrade Kit for B+	£32
Acorn 1770 DFS Upgrade Kit	£42
ECONET Upgrade Kit for BBC	£42
ECONET UPGRADES Available	

SPECIAL OFFER

Gemini's popular OFFICE MATE & OFFICE MASTER Software Packages on Disc consisting of: Database, Spreadsheet, Beebplot Graphics, Wordprocessor, Accounts. Packs: (Cashbook, Final Accounts, Mailist, Easiledger, Invoice & Statements, Stock Control

FREE
with every BBC B+ & MASTER purchased from us.

6502 Acorn 2nd Processor package	£160
Z80 Acorn 2nd Processor package	£319
ARIES IEEE Interface	£238
Acorn IEEE Interface Complete	£280
Acorn Teletext Adaptor	£125
Acorn Prestel Receiver	£115
Acorn Bitstick I	£299
Robocom Bitstick II	£759
Upgrade for Bitstick I to II	£450
Bitstick Multiplotter Driver	£65

TORCH PRODUCTS

ZEP 100 Z80 2nd Processor complete with PERFECT suite of software	£229
ZDP 240 Z80 2nd Processor, PERFECT Software and Twin 800 cased Side by Side Disc Drives	£478

(Securicor carriage £7)

By popular demand our retail shop is now open till 8.00pm every Thursday.

VARIOUS PRINTERS

● EPSON FX85 Printer	£315
● EPSON FX105 Printer	£435
● EPSON JX-80 Colour Printer	£420
● EPSON Hi-80 Printer Plotter	£319
● EPSON Paper Roll Holder	£17
● EPSON LX80 Printer	£189
● EPSON LX80 Tractor	
Feed Attachment	£20
● EPSON LX80 Single Sheet Feeder	£49
● SEIKOSHA GP50A & GP50S	£69
● Centronics Printer Cable to interface all the above Printers to BBC	£6
(Securicor carriage charge on printers £7)	

RX & FX PRINTER INTERFACES

Epson interfaces fit inside the printer to allow connection using techniques other than Centronics.

RS232	£27	RS232 + 2K Buffer	£55
IEEE 488	£65	RS232 + 8K Buffer	£75



Official ACORN Distributor

CENTRONICS GLP & Brother M1009 (NLQ) Printers

A major price break-through in NLQ Printers from Watford.

At last, a full feature Epson compatible NLQ printer at a price that everyone can afford. Due to Watford's bulk purchasing power and low margins we can now offer this incredible printer deal direct from the manufacturers to our customers.

The Centronics GLP printer which is manufactured by BROTHER (and also marketed by them under their own brand name M1009), features a Near Letter Quality (NLQ) mode using a 23 by 18 dot matrix for each NLQ character (this is the same as is used by the very popular Kaga Taxan printers). The NLQ Font Rom supplied is Watford's own Professional NLQ ROM for the GLP/M1009.

Single, double and quadruple density graphics modes as well as four character widths and super/sub script printing are also supported, along with many other facilities normally found on printers costing twice as much.

Handles upto 9" wide paper. Friction feed standard, tractor feed optional extra.

GLP is bidirectional logic seeking. Has a 9 needle print head. 50 CPS. Parallel interface only.

Special Offer £99 (carr £5)

Tractor Feed Attachment **£7**

Centronics GLP Mk2 (Brother M1109) NLQ Printer

100 CPS, (25 in NLQ mode), Bi-directional, logic seeking, Friction feed, tractor feed optional extra, 2K Buffer. Has both Centronics parallel and RS232 both as standard. Simply at the flick of a DIP switch, the Mk2 printer swaps between full IBM or Epson compatibility.

Launch Price: **£139** (carr. £5)

Tractor Feed Attachment **£7**

BROTHER HR-15XL (NEW IMPROVED FAST HR-15XL)

The new improved Brother HR15XL is a very high quality and very fast daisy-wheel printer for serious use. Notable features of this printer include a 3k buffer, 20cps, bi-directional proportional spacing, Centronics interface standard, (RS232 optional), optional Sheet Feeder and Keyboard.

ONLY £285 (carr. £7)

Electronic KEYBOARD	£135
TRACTOR FEED Attachment	£84

Ribbon Cartridges:

Fabric £3 ; Carbon £3 ; Multistrike	£5
DAISYWHEELS (various typefaces)	£18

PRINTER SHARERS

(Ideal for School environment)

Connect 3 BBC Micros to 1 Printer	£60
Connect 6 BBC Micros to 1 Printer	£129

PRINTER CHANGER

Connects 3 Printers to 1 Micro	£65
(Cables extra)	

KAGA KP810 NLQ PRINTER

This rugged printer is made by Canon of Japan and is the same as Canon PW1080. It is fully Epson FX80 compatible and offers superb NLQ printing.

Our Price: **ONLY £215** (£7 carr.)

Kaga RS232 Interface	£49
Kaga RS232 Interface + 2K Buffer	£69
Kaga RS232 Interface + 16K Buffer	£95

KAGA KP910 Printer

Similar to the KP810 but has 17" wide carriage for wide print. Gives 156 columns of normal print or 256 columns in condensed mode. Ideal for printing out spreadsheets.

ONLY £339 (£7 carr.)

PRINTER LEAD

Centronics lead to connect BBC micro to EPSON, KAGA, SEIKOSHA, NEC, STAR, JUKI, BROTHER, SHINWA etc. printers.

Standard length (4 feet long)	£6
Extra long (6 feet long)	£8
RS232 Cable	P.O.A.
IBM Parallel 1 meter Cable	£12

PLOTMATE PLOTTERS

Plotmate A4	£299
Plotmate A4M	£399
Plotmate A3M	£549
Linscan	£150

PRINTER RIBBONS & VARIOUS DUST COVERS

Type	Ribbons	Dust Covers
BBC Micro	-	£3.50
BBC Master	-	£4.00
FX100	£7.00	£5.25
FX80/MX80/FX85	£4.50	£4.95
RX80	£4.50	£4.50
LX80	£4.00	£4.50
GP80	£4.50	£4.00
GP100/GP250	£5.95	£3.95
Centronics GLP	£4.00	£3.75
KAGA KP810	£5.25	£4.75
CANON PW1080	£5.25	£4.75
Microvitec Metal Monitors	-	£5.50

Our attractive Dust Covers are manufactured from translucent PVC. The seams are stitched and edges are taped to prevent splitting due to continuous use.

Listing Paper (Perforated)

1,000 Sheets 9½" x 11" Fanfold Paper	£7
2,000 Sheets 9½" x 11" Fanfold Paper	£12
1,000 Sheets 15" x 11" Fanfold Paper	£9
Teleprinter Roll (Econo paper)	£4

Carriage on 1,000 Sheets £1.50

PRINTER LABELS

(On continuous fanfold backing sheet)

1,000 90x36mm (Single Row)	£5.00
1,000 90x36mm (Twin Row)	£4.90
1,000 90x49mm (Twin Row)	£7.50
1,000 102x36mm (Twin Row)	£6.25

Carriage on 1,000 Labels £1.00

Acorn/Olivetti JP101 Spark Jet Printer

Special Clearance Offer **£65**
Pack of 4 refills **£9**

Special
Sparkjet Dump Rom
£15

HITACHI 672 PLOTTER

Only: **£450** (Carr £6)



We stock a range of monitors to suit all needs. Choice of a monitor is a matter of personal taste so we recommend that whenever possible, you ask for a demonstration at our shop. All Monitors are supplied complete with connecting lead.

MICROVITEC 14"

- 1431 - Medium resolution as used on the BBC television computer programme **£172**
- 1451 - High resolution, suitable for word processing in mode 0 **£225**
- 1441 - High res, exceeds the capabilities of the BBC micro **£365**
- 1431AP RGB + PAL and AUDIO **£199**
- 1451AP RGB + PAL and AUDIO **£259**
- TOUCHTEC Touch Screen Pack **£250**
- Dust Cover for Microvitecs **£5.50**

KAGA/TAXAN 12"

- KAGA KX1201G Hi-res Green Monitor **£90**
- KAGA KX1202G Long persistence Hi-Res Green Monitor **£105**
- KAGA KX1203A Ultra-Hi-Res Amber Monitor **£105**
- KAGA Super Vision 3, Ultra Hi-res, RGB Colour; Text mode switch allows monochrome text display in Green, Amber, White reverse or White on Blue **£320**
- PHILIPS 12" Hi-Res Amber Monitor **£69**

FIDELITY COLOUR MONITOR

- Medium Resolution, attractively finished, 14" RGB and Composite VIDEO/AUDIO Input. Has a detachable anti-glare screen. **£169**

ZENITH

12" high resolution monochrome monitor. Ideal for word processing as its green or amber screen is very restful to read. (These are the same professional quality, stylishly finished monitors as used in the larger Zenith Micro Systems.)

Green (New Design) Hi-res **£69**
Amber (New Design) Hi-res **£79**

LEADS

BNC Lead for Zenith or Philips **£3**
RGB lead for KAGA **£3**
N.B. Carriage on Monitors **£7** (securicor)

CREDIT CARD
Orders (ACCESS or VISA)
Simply phone
(0923) 33383/50234
24 Hour Ansaphone Service

SWIVEL BASES

for Video Monitors

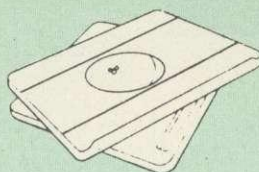

Adjust your Monitor/VDU, Up, Down, Right or Left to provide utmost in operator flexibility & Viewing comfort. It improves your sight lines & reduces stress & eye, neck and back strain. Available in 2 sizes:

for 12" Monitors **£12** (carr. £2.50)
for 14" Monitors **£16** (carr. £2.50)

GRAPH PAD

Ideal for educational use. Supplied complete with Cables, Manual and software cassette.

Special Offer £49 (carr £3)

Panasonic KX-P1080

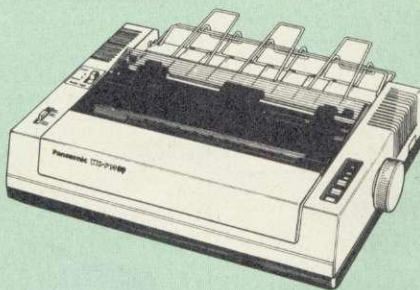

From the prodigious Japanese Stable of Panasonic comes this fabulous new NLQ Dot Matrix Printer

Available NOW at a superbly realistic price, the KX-P1080 perfectly balances features, quality of construction and Value for Money to produce the printer of tomorrow, here today, ready to sweep the current generation of machines away.

Ingenuous innovation in terms of software control codes permits great flexibility when it comes to defining the print style. A nippy 100 cps of clear Draft text backs up the crisp 20 cps Near Letter Quality text mode, with upto 40 superbly useful downloadable characters. A delightful range of assorted character widths is efficiently supported, with sizes ranging from a broad 5 cpi to petite 17 cpi, EVEN in NLQ mode. Some of the extensive support for serious use includes specialised functions to perform justification, centering and even left and right ranging. Proportional spacing permit even greater freedom when it comes to advanced use. Not only is the full Epson RX control code set implemented, but extra codes have also been added to cater for the NLQ options, etc.

A full 96 ASCII character set is supported, with an extended set of 32 international characters. A 1K Print Buffer alleviates much of the wait time normally associated with printing, whilst the bi-directional logic seeking print head takes the quickest route to print as required.

The draft text is implemented with a 9 x 9 matrix, with Near Letter Quality effected by means of an 18 x 18 matrix.

As an extra special bonus to all Watford customers purchasing the KX-P1080 NLQ Printer, we are currently providing not only 1,000 sheets of fanfold paper completely FREE of charge but also a printer lead to connect the marvellous KX-P1080 to a BBC Micro, absolutely FREE. These gifts alone are worth £15.

Introductory Price: **£165** (carr. £7)
(Price includes 1,000 sheets of fanfold paper and a 4' Printer lead)

SPECIAL OFFER

EPROMs for BBC's Sideways ROMs.

2764-250ns £2.00
27128-250ns £2.40

RAMs (Low power) for ATPL, WATFORD, etc., Sideways ROM Boards

6264LP (8K) £3.00
2 x 6264LP (16K) £5.90

BBC MICRO WORD-PROCESSING PACKAGE

A complete word-processing package (which can be heavily modified to your requirements, maintaining the large discount). We supply everything you need to get a BBC micro running as a word-processor. Please call in at our retail shop to discuss your particular requirement and a demonstration.

EXAMPLE PACKAGE

BBC Master 128K Micro, View wordprocessor, Viewsheet, Basic Editor, Terminal Emulator, Twin 800K 40/80 track double sided Disc Drives, Zenith Hi-Res green monitor, Brother HR15LX professional quality Daisy Wheel printer, Gemini Database, Spreadsheet, Beebplot Graphics, Cashbook, Final Accounts, Mailist, Easiledger, Invoice & Statements, and Stock Control packages on disc with manuals.

Only £949

THE EPSON RX/FX/KAGA PRINTER COMMANDS REVEALED

So you bought yourself a new printer, because the salesman in the shop showed you how clever it is and impressed you with all sorts of printouts to show its capabilities - he may even have offered you a special price.

However, now that you have got it home and connected it to your BBC microcomputer, you are wondering how to make it perform these magical tasks. The manual seems to give no clues, and when you type in the example programs, the computer throws the LPRINT statements back in your face.

Now what do you do, when this £400 piece of high technology refuses even to move its head, and you have stayed up until 2 in the morning with copious supplies of coffee, desperately trying to print something out. Once again, Watford Electronics comes to your help with our new book entitled 'THE EPSON FX/KAGA PRINTER COMMANDS REVEALED'.

This book describes in plain, easy to understand English, how to use and make the most of your KP810, Canon PW1080A or any Epson FX80 compatible Printer with the BBC Micro, both from Basic and Wordwise.

It describes in detail how to obtain the maximum in graphics capability from your printer and includes full indexes allowing you to cross index the numerous commands. Every command is explained in detail, with an accompanying BBC Basic program and an example of its use from Wordwise.

Superb Value at **£5.95** (No VAT)

MARK 2 LIGHT PEN

You no longer have to fiddle with the brilliance control or work in the shade as this NEW Mark II Light Pen is totally insensitive to local lighting conditions. It only operates on high frequency light from the TV or Monitor.

The red LED Indicator on the Mk II pen, lights up when valid video data is available. Your program can have access to this signal allowing computer verification of target for high res drawing. The conveniently located switch on the pen body allows the computer to ignore any stray signals. Supplied complete with the sophisticated PEN-PAL Software on Cassette or Disc. Please specify.

Mark II Light Pen **£19**

Continued →

The ULTIMATE DFSs for the BBC MICRO

WATFORD TOPS THE DFS CHART

Watford's Ultimate DFS has scored highest points in ACORN USER's unbiased DFS's Review of July 1985. In concluding, the reviewer writes "It must be said that Watford's DFS certainly offers a comprehensive range of facilities at a very attractive price". (Please write in for comprehensive details.)

Just compare the features:

Features	Acorn 1.20	Watford	
		Single Density	Double Density
Max nos. of files per disc side	31	62	62
Max disc capacity	800k	800k	1440k
Tube compatible	Yes	Yes	Yes
Built-in Editor	No	Yes	Yes
Built-in Formatter	No	Yes	Yes
Built-in Verifier	No	Yes	Yes
MRUN a file	No	Yes	Yes
MLOAD a file	No	Yes	Yes
Extended RENAME	No	Yes	Yes
Selective COPY	No	Yes	Yes
Default file name	No	Yes	Yes
Disc space distribution	No	Yes	Yes
40/80 Software Switchable	No	Yes	Yes
Wide catalogue	No	Yes	Yes
Close open files	No	Yes	Yes
Improved OPENOUT	No	Yes	Yes
Copy between densities	N/A	N/A	Yes
OSWORD & 7F	Yes	Yes	Yes
Full entry point compatibility	Yes	Yes	Yes
Retain information over a break	1.20 partial	1.43	1.53
Games compatibility	Yes	Yes	Yes
Econet file server	Yes	Yes	Most
Econet station	Yes	Yes	Yes
Full wildcard facilities	No	Yes	Yes

WATFORD's & ACORN's SINGLE DENSITY DFS

Watford's popular and widely acclaimed DFS has now been available for three years, and has gained a large following amongst serious users of the BBC Micro. Owners of Acorn or any other standard DFS can upgrade to our "Ultimate" DFS merely by replacing their DFS ROM. See below for this upgrade. (P.S. Watford's highly sophisticated DFS is fully compatible with Acorn DFSs).

PRICES

- Complete Disc Interface Kit incl. DFS ROM & fitting instructions **£54**
- Acorn's 0.90 DFS Kit complete **£52**
- DFS Manual (Comprehensive) (no VAT) **£6.95**
(P.S. Our comprehensive DFS Manual covers both Acorn & Watford DFSs)
- Watford's sophisticated DFS ROM only **£16**
- We will exchange your existing DFS ROM for Watford's Ultimate DFS ROM for only **£12**
- DNFS ROM only **£17** ● ADFS ROM only **£25**
- Watford's DFS is exclusively available from Watford Electronics. Every ROM carries a special label with our LOGO and serial number.

WATFORD's DOUBLE DENSITY DFS INTERFACE

The DDFS from Watford Electronics represents a new standard in DFSs for the BBC micro. This is a double density version of our popular single density DFS, and combines all the features of this powerful DFS with the advantages of a system that gives 80% more storage per disc in double density mode. P.S. - Please note that not all DDFSs are capable of providing either the full 80% storage increase, or of allowing a file the full size of the disc - Ours allows both of these! Operates both in Single & Double Density modes.

The typical piece of games software these days is provided upon a protected disc. In order to work on any double density system (including the others on the market) a protected piece of software needs to make calls through the OSWORD & 7F routines. To ensure compatibility, the Watford DDFS features probably the most comprehensive and powerful 8271 emulation ever written for a double density system.

PRICES

- Complete DDFS Kit incl. fitting instructions **£46**
- DDFS Manual (no VAT) **£6.95**
- We will exchange your existing Single Density DFS Kit for our DDFS Unit at **£35**

Watford Electronics DDFS PLUS for the BBC B Plus

The Watford DDFS Plus, written specifically for the BBC B Plus Microcomputer, replaces the 1770 DFS from Acorn. It not only provides BOTH, single and double density operations in DFS mode, but the DDFS Plus also permits the use of an extended catalogue, giving 62 files per catalogue. It also incorporates all those excellent features of the popular Watford DFSs, and more.

N.B. SRAM and Tube functions not duplicated.

DDFS PLUS (for BBC Plus) £30
(Price includes comprehensive manual)

MYSTERIES OF DISC DRIVES & DFS REVEALED

Are you tired of faulty cassettes, and lengthy loading times? Do you want to upgrade your BBC micro to take discs but you get tied up in the plethora of jargon surrounding the choice and use of these systems.

For instance, what is the difference between single and double density formats, how can you use a 40 track disc on an 80 track disc drive? What is the difference between a DFS and disc interface kit? Should you acquire a single Disc drive or twin? What does 48 TPI and 96 TPI discs mean? These are just a few of the questions you may have asked yourself and never found the answer or maybe you have yet to encounter these questions.

Now the mystery of buying a suitable interface and disc drive for your BBC micro is revealed in Watford's new book entitled 'MYSTERIES OF DISC DRIVES & DFS REVEALED'. It describes in fine detail, yet remaining very readable to the beginner, how disc drives operate, the type of interfaces available, which type of discs to use on a disc drive and how data is stored on the discs.

£5.95 (Book No VAT)

DISC ALBUMS

Attractively finished in antique brown leather look vinyl. Stores upto 20 Discs. Each disc can be seen through the clear view pocket.

£4

STAK-PAK



The unique computer program filing and storage system. Made of tough black plastic, these compact drawer sections hold two cassettes each and lock together vertically to form miniature cabinets of any height. Each drawer section has two C12 Data Cassettes with labels plus external index card.

Five twin Packs incl.
10 Cassettes Only: **£5**

FLOPPY HEAD CLEANER KIT

The heads in floppy drives are precision made and very sensitive to dirt. The use of a cleaner Kit is a sensible precaution against losing valuable data. It is recommended to clean the drive head once a week. It is very simple to use.

£8

LOCKABLE DISC STORAGE UNITS

Strong plastic case that afford real protection to your discs. The smoked top locks down. Dividers and adhesive title strips are supplied for efficient filing of discs.

M35 - holds upto 40 discs **£9**
M85 - holds upto 95 discs **£11**

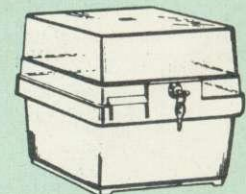

PLASTIC LIBRARY CASES

FOR 5¼" DISC STORAGE
holds 10 Discs.

£2.00

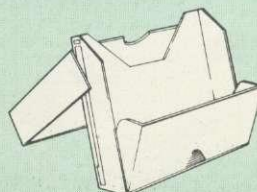

Quality Disc Drives from Watford

To help you decide which drive is the most suitable for your needs (and your pocket!), we have produced the table below.

The first capacity given in the first column indicates the single density capacity. The double density storage capacity is second one, (that within the brackets). All disc Drive type numbers start with the prefix "C".

The tinting on some of the boxes is used to indicate which Drives are 40 track (non-tinted) and which are 80 track (tinted). Both are of Japanese manufacture.

With two prices in a box (e.g. £295/£299), the first price is for the standard drive and the second for the same unit in switchable type. Users of either of the two Watford DFSs will not need switchable drives as their DFS will provide software switching for them.

All our Disc Drives (except CLS100) are Double Sided and will operate in both Single and Double Density modes. Extensive experience of the usage of disc drives suggests that the JAPANESE drives currently represent about the best in terms of speed, reliability and overall "elegance" available for the BBC Micro.

Various other "manufacturers" of disc drives for the BBC micro (more accurately, "packagers" label other manufacturers drives with their own name). We buy the high quality Epson and Mitsubishi drives in large quantities directly from the manufacturers, package them and sell them at "dealer" prices direct to the public.

If you look around the popular BBC micro press, you will find that the prices we quote for the top quality, new slimline disc drives are, virtually without exception, some of the best around. These prices, coupled with the backup of one of the country's largest distributors of BBC peripherals provides a superb deal.

Unless you anticipate using dual drives in a fully expanded BBC system for long periods of time with little ventilation, then we suggest that our range of "CL" disc drives without the PSU (Power Supply Unit) would be quite adequate: extensive tests within our workshops have confirmed this. All drives are supplied complete with a SPECIAL UTILITIES Disc, Cables and Plugs. The Drives with power supply have a mains moulded plug for safety purposes. (Ideal for Schools & Colleges. We are now able to supply all single Disc Drives with Power Supply, in either single or dual cases. (Dual cases with a blanking plate, allow easy expansion at a later date.) Prices stated in the pricing box below for single drives in a single case. Single drives with dual cases cost an extra £5. (At Watford we anticipate your needs of tomorrow, not just today!)

When using a BBC Micro, most people find themselves short of space. The Watford's BBC Micro plinths form an ideal way of recovering some of this precious space; your BBC, Disc Drive and Monitor can all occupy the same vertical footprint and still be comfortably situated. With the Watford Double plinth, your Disc Drive is mounted vertically at one side, leaving a very valuable area directly in front of you for such useful items as spare discs, pen, paper, reference manuals, etc. Follow the trend with Watford plinth. (Turn to the 8th page of our advert for the Plinths).

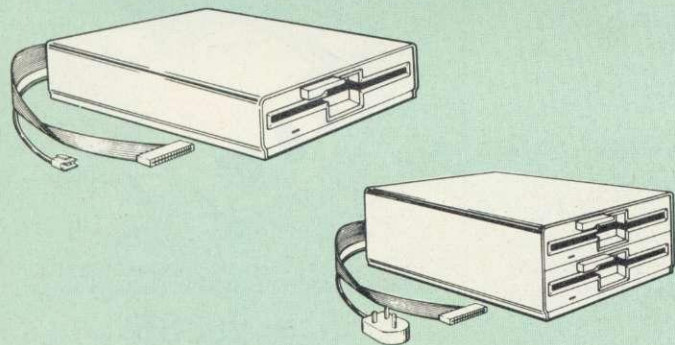

Capacity	Drives without P.S.U.		Drives with P.S.U.	
	Single	Twin	Single	Twin
100K (180K)	CLS 100 £95		CS 100 £116	
200K (360K)	CLS 200 £102	CLD200 £185	CS 200 £116	CD200 £199
400K (720K)	CLS 400 £104 £105 CLS400S	CLD 400 £185	CS400 £123 £124 CS 400S	CD400 £205
800K (1.44M)		CLD800 £194 £195 CLD 800S		CD800 £218 £219 CD 800S

● TWIN Disc Drive Case, complete with Power Supply & Cables **£35**
Securicor carriage on Disc Drives **£6**

Prefix **C** = Cased Drive
L = Less PSU
S = Single
D = Double

Suffix **S** = 40/80 Switchable

e.g. CLS400S = Cased drive, Less power supply unit, Single 400K, Switchable (40/80 track).

3M - DISKETTES

Top quality 3M - SCOTCH Diskettes from Watford Electronics (Your 3M Appointed Distributors). All our discs carry a lifetime warranty. These discs are quiet in operation and insert positively with their reinforced hub rings. Boxes of 10 supplied complete with self stick disc labels and write protect tabs.

- 10 x 5 1/4" S/S D/D 40 Track Diskettes **£10**
- 10 x 5 1/4" D/S D/D 40 Track Diskettes **£12**
- 10 x 5 1/4" S/S D/D 80 Track Diskettes **£17**
- 10 x 5 1/4" D/S D/D 80 Track Diskettes **£17**
- Hi-Density 1.6M D/S D/D for IBM **£32**

- 3 1/2"** ● 10 x 3 1/2" S/S D/D 40/80 track Discs **£25**
- 10 x 3 1/2" D/D D/D 40/80 track Discs **£35**

TOP QUALITY 5 1/4" DISKETTES

To complement the range of quality discs and disc drives that WE already sell, WE are now supplying some special offer packs of 10 high quality discs. Each Disc has a reinforced hub ring and carries a lifetime guarantee. These are supplied complete with selfstick labels and packaged in an attractive plastic library disc box to protect them from damage. We strongly recommend these Discs.

DON'T SETTLE FOR LESS, BUY THE BEST

- 10 x **M4** S-S D/D 40 Track Discs **£9**
- 10 x **M5** D/S D/D 40 Track Discs **£11**
- 10 x **M7** D/S D/D 80 Track Discs **£15**
- 3" Double Sided Discs **£4 each**

Special BULK OFFER on 5 1/4" DISCS

(Supplied packed in plastic storage Units)
(Lifetime warranty on Discs)

Type	Description	Pack of 20	Pack of 50
M4	Single/Side Double/Density 48TPI	£16	£40
M5	Double/Side Double/Density 48TPI	£20	£52
M7	Double/Side Double/Density 96TPI	£27	£65

DUST COVERS (For our Disc Drives)

Single CLS (without PSU) **£3.20** Twin CLD (without PSU) **£3.85**
Single CS (with PSU) **£3.95** Twin CD (with PSU) **£3.90**

ACORN WINCHESTER DRIVES

Suitable for direct connection, via the 1MHz bus, to any BBC running ADFS. These Acorn Winchester disc drives are fast and extremely reliable. Each Winchester comes complete with the Level III Econet File Server software.
10 Megabytes **£1050**; 30 Megabytes **£1549**

CDP 800S

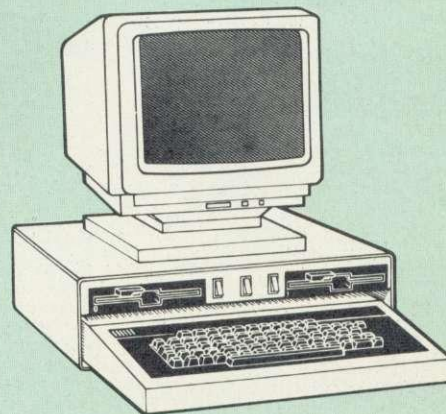

Twin 800K Double sided 40/80 track switchable disc drives mounted in an attractively finished Beige colour plinth for the BBC Micro. Supplied complete with integral power supply, cables and Utilities disc. The switches are mounted on the front panel for ease of use.

Introductory price: **£239**
(Securicor Carr. £7)

EPSON NLQ ROM for the BBC Micro

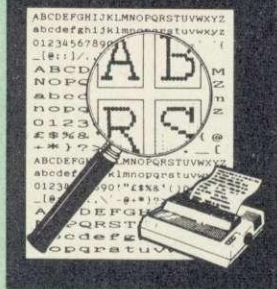

Harness the full potentials of your Epson RX & FX Printers. Impress your friends and business colleagues with the quality of your letters and printed material with Watford's very simple to use EPSON NLQ! (Near Letter Quality) ROM. Suitable for FX80, RX80, RX80FT, FX100.

Look at the features:

- Simply type *NLQ80/100 and a single VDU code to use NLQ print.
- NLQ is then available without any modifications from BASIC, WORDWISE, VIEW (with NLQ DRIVER) or virtually any other program or language.
- Single codes select PROPORTIONAL type (yes even on the RX80); ENLARGED type; UNDERLINED type. These features can be used separately or in any combination.
- Full UK character set; Standard 'pica size'; Proportional spacing; Enlarged; Underlined; Normal type.

The NLQ ROM is supplied complete with comprehensive manual.

P.S. NLQ ROM is compatible with the Torch Z80 system and can be used from within the Perfect Writer software.

Only: £25

VIEW PRINTER DRIVER for NLQ ROM

This specially written printer driver has been designed to allow View access to the full features of our NLQ ROM. A must for all VIEW and NLQ ROM users.

£7.00

(Hi-View compatible)

THE NLQ DESIGNER

KAGA KP810/910 and Canon PW1080 are two superb printers, as our many thousands of satisfied customers would surely attest to. One of its particularly strong points is the NLQ option that it offers; perhaps one of the more weaker points is the effort required to design your own custom NLQ font.

Well the solution is here NOW in the shape of Watford's NLQ DESIGNER ROM! For the BBC Micro. This powerful piece of software allows easy design and entry of a full NLQ font, with further fonts recallable from disc. Once a font has been programmed with the versatile NLQ DESIGNER, it can be saved to disc, downloaded to your Kaga (or Canon) printer, or even programmed into an EPROM (given the appropriate hardware) and then plugged directly into your printer so that it is available immediately when you turn it on. Downloadable Fonts require 6264 RAM chip fitted. Now BBC Master compatible.

A 40 or 80 track (please specify) disc containing 3 example fonts is included in the package.

(P.S. This ROM is not suitable for Epson printers.)

- NLQ Designer ROM & FONT Disc £25
- Kaga Individual FONT ROMs £15

(Write in for further details).

ALL PRICES EXCLUSIVE OF VAT

DUMPOUT 3

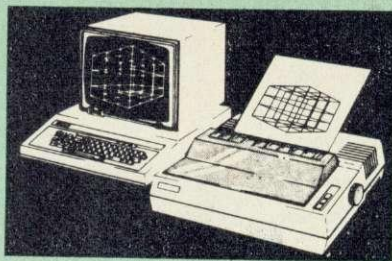

A highly sophisticated screen dump ROM. This has to be the most flexible and powerful screen dump ROM yet produced for the BBC micro. It will put on paper anything you see on the screen, including all Mode 7 facilities etc. We have to admit that there is one facility that we cannot replicate - if anyone can supply flashing ink we would like to know!

The ROM also provides window setting utilities and two new OSWORD calls that allow mode 7 graphics pixels to be read and plotted using the standard graphic co-ordinate system. The latest version includes a graphic dump trigger for dumping screens from games whilst they are running.

Two commands are used to operate the dump routines:

*GIMAGE - This provides a full graphics dump of any graphics mode, plus modes 7 and '8'. There are many optional parameters but you need only specify the parameters you wish to change.

Features available include:

- Vertical and horizontal scaling through all the graphic modes and mode 7
- Rotation of the image produced through 90, 180 and 270 degrees
- Left hand indentation setting
- Screen dump window definition
- Colour grey scaling
- Two tone fast dump
- Special colour mask
- Mode 7 contrast expansion
- Mode 7 contiguous dump
- Key triggered dumps
- User port switched dumps

What does the independent press say!

Practical Electronics, May 1985
"The Dump Out 3 ROM from Watford Electronics represents one of the most sophisticated types of printer dump utilities available for the BBC Micro . . ."

"an extremely sophisticated and powerful dump utility".

"VERDICT - Dump Out 3 ROM has all the facilities which you are ever likely to need for producing printer dumps. The facilities available work extremely well and if printer dumps are something which you require, then this ROM can be recommended to help you to get the best out of your dot matrix printer".

The Micro User Feb. 1985.
"Well, here is that winner!"

"provide(s) some rather sophisticated screen dumps. Producing high resolution paper copies of graphic screens in any (graphics) mode will be the major reason for buying this ROM, and this is where Dump Out 3 performs PAR EXCELLENCE". (Our capitals for their italics.)

"The versatility of *GIMAGE (the graphics dump command) when using these parameters is amazing. Pictures of almost any size, shape, contrast or distortion may be produced without the need for a reducing photocopier or trick photography".

"Without reservation I wholeheartedly recommend the Dump Out 3 ROM as the ultimate screen dump facility for the BBC micro. It is easy to use yet highly versatile, and caters for all BBC screen modes in multitone high resolution printing. Whole, partial, rotated and scaled screens may be dumped to almost any BBC compatible dot matrix printer (see our list at the end of this advert). At £25 it must represent excellent value for money and surely cannot be beaten".

Designed for use with the following printers:

GLP, GP80/100/250, CANNON, STAR, KAGA/TAXAN, NEC, SHINWA CP80, GEMINI, EPSON MX/RX/FX, M1009, NEC PC8023, DMP100/200/400, Mannesman Tally etc.
Price including comprehensive manual

£25

ROM MANAGER

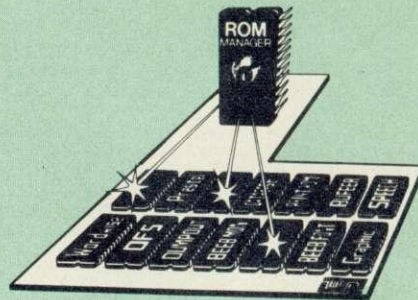

Probably the most powerful way of expanding the BBC micro is from the use of Sideways ROMs. One problem faced by the avid ROM collector is that of ROM command clashes. The solution is very simple in the form of the ROM that "Provides comprehensive management of all your installed ROMs". (Quote from BEEBUG November '84.)

Basically, ROM Manager offers you the ability to turn off any installed ROM, or to send any * command to any specific installed ROM. It is said that imitation is the sincerest form of flattery - Acorn's BBC Plus features many of the abilities of this powerful ROM.

Many more facilities available.

SPECIAL OFFER £18

THE AMX MOUSE

The AMX Mouse needs no introduction. It is simply the best.

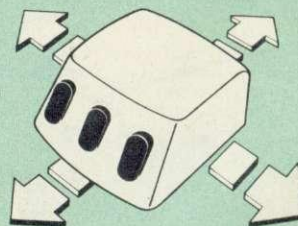

Now supplied with the NEW SUPERART Software ROM & Disc at no extra cost.

ONLY: £65 (carr £1.50)

FREE With every AMX Mouse package purchased from us, we are giving away, absolutely FREE, our popular Colour Art software package worth £15.

AMX DESK Package	£19.00
AMX UTILITY Package	£11.00
AMX SUPERART Package	£42
AMX PAGE-MAKER Pack	£42
AMX 3D ZICON Disc	£20
AMX Database Disc	£20
AMX XAM Educational	£20

RB2 MARCONI TRACKER BALL

This popular unit is supplied complete with software.

Price: £50

FLEET STREET EDITOR

Software pack £35

TRANSFEROM

(Tape to Disc Utility)

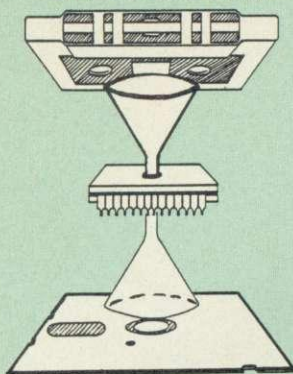

Not compatible with 1770 DFS.

This advanced and sophisticated utility ROM for the BBC Micro has the following features:

- Fully menu driven for ease of use
- Copies with locked programs
- A very comprehensive built in copying features
- Copies very long adventure games
- Supplied with comprehensive manual

TRANSFEROM is now available in BOTH single and double density versions. The single density version works with both the Acorn and Watford single density DFSs. The double density version works with the Watford DDFS system only.

TRANSFEROM takes your software on tape and saves them onto disc. TRANSFEROM does not stop when one disc is full; you just insert another disc in and carry on with that one! Surely this is the most valuable investment you could make if you have tape software that you wish to transfer to disc! Please specify version required - Single or Double Density.

£25.00

DIAGNOSTICS DISC

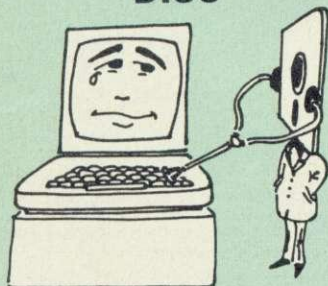

The BBC micro is a very complex machine and thus diagnosing a fault can be very difficult. Until now, the only way to discover the nature of a fault was either to find a competent friend with a large degree of patience or to find your nearest dealer and pay him to find out what is wrong.

At Watford Electronics, we realise how difficult it can be when faced with a problem, finding yourself a long way from your nearest dealer, or even just uncertain about your Beeb's health, but not wanting to waste time and money taking it to be looked at.

The solution to these problems is here now, in the form of the Watford's Diagnostics Disc. This excellent utility is specially designed to test out the following areas of your Beeb:

RAMs, ROMs, ULAs, Sound, Keyboard, Disc, RS423, ADC, User Port, Printer Port, Cassette, Joysticks, Speech, Disc Drives, 6502 and Z80 2nd Processors.

This utility is an invaluable aid for all those who take the reliability of their system seriously. A comprehensive manual provides full operating details and a list of possible causes and remedies for any faults that you may find along the way. The package also enables a permanent equipment and service record to be maintained.

Only £20.00

ROMAS

THE CROSS ASSEMBLER AND MACRO EDITOR FOR SERIOUS PROGRAMMERS!

ROMAS is a carefully designed, sophisticated yet simple to use, development system for serious assembly language programmers. Using the BBC as the development system, you can choose your target system from the following processors:

6502, 65C02, Z80, 8085, 8041, 6809 and Z8 P.S. This includes the Acorn 6502 & Z80.

ROMAS features a powerful expression analyser, making complex table easy to generate. To aid in documentation, fully formatted assembly listings may be produced, with full symbol table output at the end.

ROMAS is provided with a powerful cross referencer to produce a listing of all the labels in a given "source" program; this makes it easy to check to see if you are about to duplicate a label.

The Macro Editor

Features of this powerful editor provided with the ROMAS package include:

- Works in all 40 and 80 column screen modes
- Fast load and save speeds
- Continuous line and column number displays
- Search, replace and move; all available in macros
- Command repetition

The ROMAS package includes a comprehensive manual, providing detailed documentation and plenty of examples.

A give away at... **Only £45**

Please specify 40 or 80 track disc when ordering.

ROM-SPELL

"way ahead of any competition"



ROM-SPELL is probably THE most advanced and fastest spelling checker available for the BBC Micro. Printed below are some extracts from a recent independent review (A&B Computing Nov. '85), which we feel sure will convince you that this is THE only spelling checker worth considering.

"The editing system is very neat and simple, instead of replying to queries and beeps all of the time..."

"The other feature which places ROM-SPELL way in front of any competition is the ability to examine the user dictionary, so any spelling mistakes that have found themselves on the disc can be examined and taken out if necessary".

"... that it is compatible with many of the popular word processors on the market is a good indication that ROM-SPELL is going to be a very popular product indeed".

"... ROM-SPELL is by far the best spelling checker for the unexpanded BBC B (with or without word processor). It boasts features which are hard to find on conventional spellcheckers on CP/M and MSDOS, namely Spellstar and has a speed/performance ratio of roughly the same as its CP/M cousin. The difference is that the CP/M version would cost the best part of £500".

"... and with such vital house keeping features as an ambiguous word checker, the ability to edit the user dictionary, a comprehensive manual that is both easy to read and actually ENJOYABLE to learn from, ... I feel confident that ROM-SPELL will woo the word processing public with no problems at all".

Compatible with: View, Wordwise & Wordwise

Don't settle for less. Buy the best.

£25

(Not compatible with 1770 DFS)
(Please state 40 or 80 track disc)

COPY HOLDERS

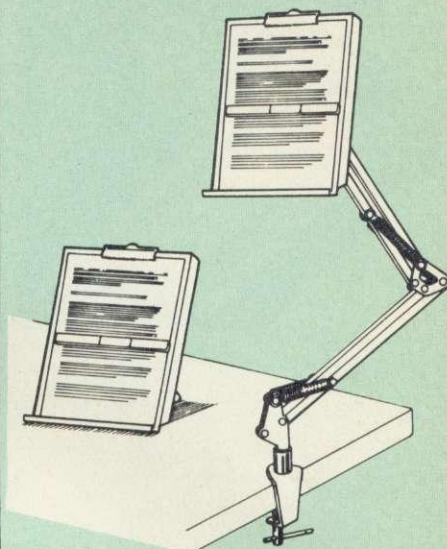

How often have you been about to type hand written notes into your computer when you find that there's nowhere to rest the paper or that your notes are resting at the wrong angle to read the type? Whether the notes be your latest program or the draft of a new trilogy, the new Manuscript Holders from Watford are superb for holding your paper at the ideal height and angle to allow you read and type in ease and comfort.

Available in desk resting and shelf clamping versions, these two units hold your paper firmly by means of a magnetic ruler and a clip grip.

Mounting to a convenient flat surface, the two joint anglepoise Manuscript Holder allows the paper to be positioned at virtually any convenient angle whilst only taking up a fraction of the surface area that the paper being held does.

The smaller desk resting Manuscript Holder is useful for the more organised desk where the problem is simply holding the paper at the right angle.

Whatever desk arrangement you use, surely you deserve a Watford Manuscript Holder!

Amazing value at only
Desk Top **£10** (carr. £2)
Angle poise **£14** (carr. £3)

All prices in this advert are exclusive of VAT.

REPLICA 3

This new improved REPLICA 3 from Clares is a very powerful disc based TAPE to DISC Utility. It now transfers even more programs than ever before. Replica 3 will not work with all programs but then neither will anything else. 30,000 Replicas have been sold to date. It has to be good.

£13 (40 or 80 track)

BEEBMON

The most powerful machine code monitor for the BBC Micro **£24**.

DISASSEMBLER ROM

ONLY £16

THE INVESTIGATOR

This sophisticated Utility program on disc, enables you to make security back-up copies of most of your valuable Disc Software. Makes full use of all 8271 (will not run with double density DFSs) facilities to discover the precise format of your protected disc so that an exact copy can be produced. Supplied with detailed instructions. Please specify 40 or 80 track disc when ordering.

Only £20

Continued



SIDEWAYS ZIF SOCKET

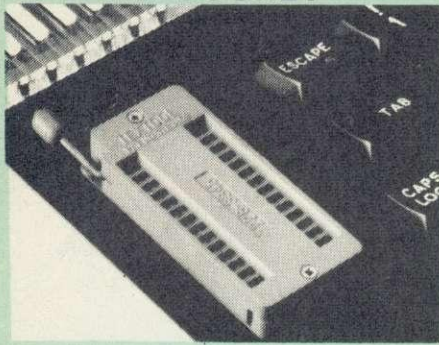

Allows you to change your ROMs quickly and efficiently, without opening the lid. The ZERO INSERTION FORCE (ZIF) socket is located into the ROM Cartridge's position.

- Very simple to install. NO SOLDERING required. The ZIF (Zero Insertion Force) eliminates the possibility of damage to your ROM pins when inserting & extracting.
- The low profile of the socket allows unrestricted access to the Keyboard.
- All data and address lines are correctly terminated to ensure correct operation of suitable ROMs with the BBC micro. We also supply a purpose designed see-through storage container with anti-static lining, allowing you to store up to 12 ROMs, protecting them from mechanical and static damage.
- This versatile hardware solves the problem of running out of socket space. Simply lift the ROM from the ZIF & insert a different one (No pulling or pushing of Cartridges. It is a must for all professionals and Hobbyists alike.)
- BBC, B+ and Master compatible.

ONLY £15 (carr £2)

Low Profile CARTRIDGE SYSTEM

Complete System consists of: Low profile ROM Cartridge, Socket housing, Cable assembly, 5 labels and a library storage rack.

Complete System £12
Spare Cartridges £2.50
Spare Rack £1.50

16K Sideways RAM Modules

This is it! The revolutionary design RAM Module you've been waiting for. Complete with such features as read and write protection, these new modules from Watford Electronics are ideal for the hobbyist, software developer and ROM collector.

Key points to note about this new addition to the Watford range of products are:

- Write protection (useful in a variety of circumstances).
- Read protection (allows recovery from ROM crashes).
- Compact construction.
- May be fitted in systems even with a ROM board.
- Multiple units may be fitted, even with a ROM board.
- No overheating or overloading problems.
- Free utilities disc supplied.
- Can be used as a 16K PRINTER BUFFER.
- Ideal for professional software development.
- Supplied with utilities software disc.

Only: £29 (carr £2)

Optional extras

READ and WRITE protect Switches £2 each
Battery for Battery Backup £3

All prices exclusive of VAT

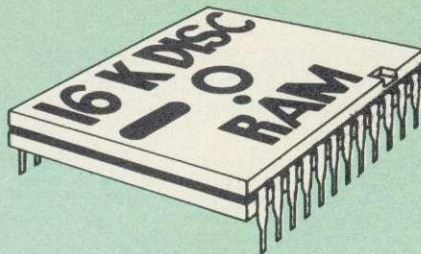

This is the RAM you've been waiting for!! This battery backed up, write protectable 16K sideways RAM board allows you to run from disk every sideways ROM available. Beware of other sideways RAM boards which are not backed up as certain ROMs will not run in these boards even though the RAM can be write protected. The Battery Backup facility allows retention of DATA after power off. On switch on the Micro will think the WATFORD DISC RAM is a ROM. Features available are:

- No soldering or modifications to BBC micro necessary.
- Plugs into normal ROM socket fitting neatly under the keyboard allowing room for other add-ons.
- Easy to use. Comes with disk based software to SAVE and LOAD ROMs. Allows you to make backup copies of your ROMs.
- Disk software can be copied onto other discs when disc is full.
- No messy plugging and unplugging of your ROMs. Simply Load the one you want into DISC RAM.
- Ideal for Professional users to develop ROMs. Backup facility allows testing of final versions without using EPROMs.
- The switch provided allows backup and write protection to be switched off externally.
- Can also be used as 16K printer buffer RAM in conjunction with our Buffer & Backup ROM.

New Low Price: £30 (carr £2)

P.S. 16K DISC RAM Board is not designed to work in conjunction with a Sideways ROM Board.

SOLID STATE 16K SIDEWAYS RAM

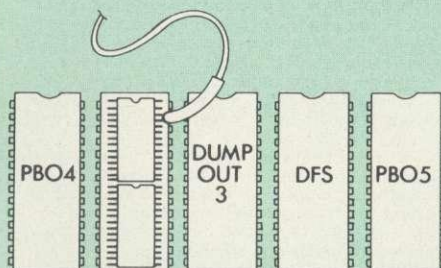
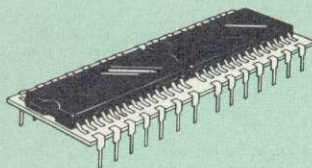

This new unit from Watford, which utilises the latest in Static RAM technology, offers 16k of easy-fit sideways RAM in a very compact unit with a footprint no larger than a standard 28pin EPROM. With only a single flying lead terminating in a mini hook-on probe, to fit, (no soldering required) this compact unit works with any BBC Micro with or without a ROM board. **Compatible with BBC B Plus.** Like our other 16K RAM Modules, this unit is very simple to fit.

Only £28 (carr 2)

Supplied complete with comprehensive software on Disc, Operating and fitting instructions.

Do you find the 16K Sideways RAM Units confusing? If so, we have compiled this quick questionnaire to help YOU decide which is the best one for you. If the answer to any of the questions is yes, then use the index number to select from the boards below. Options in brackets indicate possible secondary choices.

Do you require:

- Sideways RAM for a BBC B? Choose 1, 2 or 3.
- Sideways RAM for the B+? Choose 3.
- A small, basic module? Choose 3.
- A sideways RAM module for a ROM board? Choose 1 or 3.
- An easy to use utilities disc? Choose 1, 2 or 3.
- More than one module installed at once? Choose 1 or 3.
- To use sideways RAM as a printer buffer? Choose 1 or 3.
- Battery Backup? Choose (1) or 2.
- Write protect for RAM (makes ROM look like RAM)? Choose (1) or 2.
- Read protect (allows recovery from crashes)? Choose 1.

Key:

- 1) 16k Sideways RAM Module
- 2) 16k Disc RAM
- 3) Solid State 16k Sideways RAM

SOLDERLESS SIDEWAYS ROM SOCKET BOARD

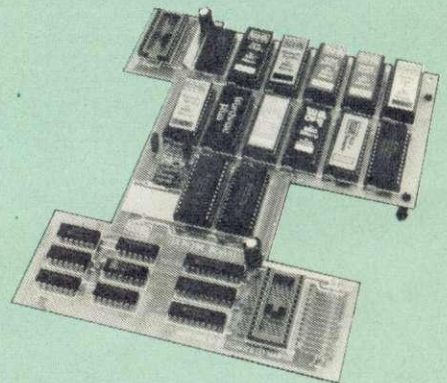

In the May 1986 Micro User's independent review, the writer concludes, "The board has been well laid out. Its position is much better than others - not over the HOT RAM chips and further away from the disc controller area". "I give the solderless ROM board the thumbs up and wish it success".

This brand new board from Watford Electronics is designed specifically for those wishing to add a ROM board to their own BBC without the need to perform any soldering.

This new board expands the total possible number of ROMs in a BBC from 4 to 16. Also permissible, are various configurations of RAM (up to 16k) and different sized EPROMs (see below).

Unlike our competitors inferior boards, the ONLY upgrade required for fitting battery backup to the Watford Solderless ROM board (all Watford ROM boards, actually) is the fitting of the battery itself. (No other expensive components are required.)

- The key features of this new, no fuss, easy to install quality product from BBC leaders Watford Electronics are as follows!
- Increase your BBCs capacity for ROMs from 4 to 16.
- **No soldering required.**
- Very low power consumption.
- Minimal space required.
- Compatible with Torch, DDFS, RAM Card, 2nd Processor, etc.
- Socket 14 can take the following chips: 2716, 2732, 2764, 27128, 6116, 6264.
- Read protect to make RAM "Vanish"; allows recovery from ROM crashes.
- Battery backup option for RAM chips.
- Supplied ready to fit with comprehensive instructions.

Price: Only £32

Battery backup fitted £36
(carriage £2)

Watford ROM/RAM CARD

A must for all serious users

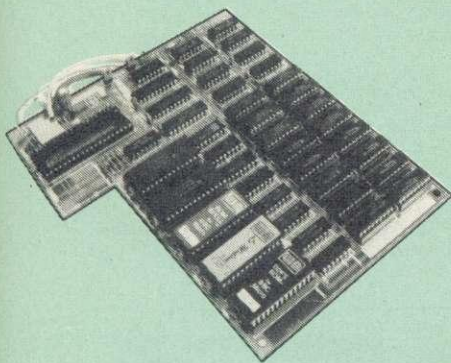

Watford Electronics announced the first ever commercial ROM board for the BBC micro, the Watford Electronics 13 ROM Socket Board 3 years ago. Following the success of this board, we have designed what probably represents the ultimate in expansion boards, the new Watford Electronics ROM/RAM board. This highly versatile and sophisticated board represents the latest in "2nd generation" sideways ROM technology for the BBC micro, designed to satisfy the serious BBC user.

- NO SOLDERING required to fit the board.
- NO overheating problems.
- No User Port corruption (avoids problems with the mouse, modems, Eprom Programmers, etc.)
- Fully buffered for peace of mind.
- Firm mounting in BBC micro.
- Compatible with all BBC micros (not BBC+ or Master).
- Total number of ROMs increased from 4 to 8.
- Up to 8 banks of sideways RAM (dynamic).
- Option for 16k of Battery backed CMOS RAM (CMOS RAM needs one ROM socket).
- Software Write protect for ALL RAM.
- Read protect for CMOS RAM (ALLEVIATES crashes during ROM development).
- Separate RAM write register (&FF30 to &FF3F).
- Automatic write to currently selected RAM socket for convenience.
- Accepts any ROM.
- FREE utilities disc packed with software.
- Compatible with our DDFS board, 32k RAM Card, Delta Card, sideways ZIF, etc.
- Large printer buffer.
- UNIQUE Fully implemented RAM FILING SYSTEM (similar to the popular Watford DFS).
- ROM to RAM load and save facilities.

The SFS (Silicon Filing System) can utilise up to the full 128k of RAM (with the SFS in any paged RAM) as a SILICON DISC. This behaves as a disc drive, with all the normal Watford DFS features (including OSWORD & 7F for ROM-SPELL, etc.) to provide an environment that looks like a disc but loads and saves MUCH faster.

The ROM/RAM Board plugs into the 6502 CPU socket. This leaves free all the existing ROM sockets, which can still be used normally.

Any ROM that can be plugged into the BBC micro's own ROM sockets may be used in the ROM/RAM Board.

The ROM/RAM Board is supplied with all ordered options fitted as standard. Upgrade kits (with full instructions) are available for all of the options, should the user wish to upgrade in the future. Please write in for further details.

INTRODUCTORY PRICES:

- ROM/RAM card with 32k dynamic RAM **£45**
 - ROM/RAM card with 64k dynamic RAM **£65**
 - ROM/RAM card with a massive 128k dynamic RAM **£99**
(carriage on ROM/RAM Card £3)
 - 16k plug-in Static RAM kit **£6**
 - Battery backup **£3**
 - Read and Write protect switches **£2 each**
- Complete ROM/RAM board
(all options installed) **£115**

Le Modem



The MODEM from Watford

At last a professional MODEM for the BBC Micro. Unlike other 'Modem packages' this is a complete package there are no extra software costs to get 'up and running'. Of course Le MODEM is multi-standard, i.e. 300/300, 1200/75 & 75/1200 UK and BELL (USA) are all supported.

The features that make Le MODEM such good value are:

- A complete communications terminal that transforms your BBC Micro into a very powerful World/wide data transfer system.
 - Auto Dials, Auto Answers, and is completely controlled by your Micro. There are no external controls!
 - Allows you to access PRESTEL, B.T. GOLD, THE SOURCE, MICROLINK, MICRONET, MICROWEB, THE TIMES NETWORK, MICRO LIVE (BBC TV database), CITY BB and more.
 - Designed to be SIMPLE but SOPHISTICATED. To LOGON to a data base all you have to know is its TELEPHONE NUMBER, Le MODEM does the rest.
 - Supplied with a comprehensive telecomms package in a 16K sideways ROM which includes a FULL PRESTEL terminal allowing TELESOFTWARE to be downloaded.
 - A comprehensive 80 column terminal. This includes XMODEM error checked transfer protocol, to allow error free data transfer anywhere in the world!
 - FULLY controlled by simple *COMMANDS allowing you to control it from your own BASIC programs. To get you started we supply a FREE disc of bundled software!
 - Connects to the 1MHz bus. A *AUDIO ON/OFF command allows you to actually hear the telephone line through your BBC micro loudspeaker.
 - Completely self contained with internal mains power supply. (Even a free mains plug is fitted!) A *TEST facility gives ON SCREEN indication that Le MODEM is working correctly.
 - Packaged in such a way that you need nothing else except a BBC Micro to communicate with computers all over the world.
 - FREE 3 months subscription to MicroLink.
- BT Approval applied for.

Price: **£89**
(carr £3)

(Price includes, Le Modem, Software ROM, Cables & Comprehensive Manual)
(Write in for further details)

PROHIBITED from direct or indirect connection to any telecommunication system run by British Telecommunications. Action may be taken against anyone so connecting this apparatus.

Nightingale Modem

SPECIAL PRICE to our Customers

£115
(carr £3)

(Price includes: Nightingale Modem, Commstar ROM pack, Cables & Comprehensive manual)

- Nightingale Modem without software **Only £99**
- COMMSTAR ROM package only **£29**
(P&P on modem £2.00)
- Auto Dial/Auto Answer Board **£48**
- Auto Dial Utilities Disc **£9.50**
- OBBS Bulletin Software **£20.00**

Viglen Console Unit

Enhance the appearance and convenience of your BBC Micro with the Viglen console unit.

£42 (carr. £4)

BT TELEPHONE CONNECTORS

LJU 1/4A Mini Line Master	£4.50
LJU 1/6A Mini Line Slave	£3.00
LJU 2/4A Line Master	£4.00
LJU 2/6A Line Slave	£2.50
LJU 3/4A Flush Master	£3.95
LJU 3/6A Flush Slave	£2.75
LJU 10/3A Dual Splitter	£5.50
4 Way BT Plug	£0.75

Versatile BEEB SPEECH SYNTHESISER Unit



The Watford Speech Synthesiser is a very flexible speech synthesis unit based upon the powerful phonemes system. This system stores the building blocks of speech (called phonemes) and allows you to combine them quickly and easily to form virtually any word imaginable.

Supplied with an advanced ROM, you are provided with a 500 word dictionary to get you started. These can easily be added to by following the notes given in the comprehensive manual.

SPECIAL PRICE £32 (carr £2)

PLINTHS FOR BBC MICRO, MASTER & PRINTERS

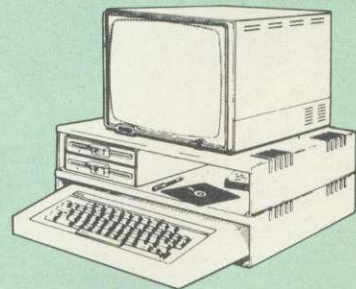

Protect your computer from the weight and heat of your monitor. The BBC micro plinths have slots for maximum ventilation. The single plinth is suitable for a BBC and monitor, whilst the double height version provides enough room for our stacked or side-by-side dual disc drives or TORCH Disc pack, to be placed in the centre section. If you use our stacked drives, the remaining space can be used for further peripherals e.g. Speech Synthesizer, EPROM programmer or simply stationery. The computer slides neatly in to the lower section allowing easy access to remove the lid. The printer plinth is equally sturdy but without the cooling slots. It allows for access to the paper from the front as well as from the rear, (a facility not often thought of in similar products) if the paper is located beneath the plinth. This is a very convenient way to work especially if your work area is not deep enough to take the printer and paper separately.

SINGLE BBC PLINTH	£11 (carr. £1.50)
DOUBLE BBC PLINTH	£20 (carr. £2.00)
PRINTER PLINTH	£10 (carr. £1.50)
SINGLE MASTER PLINTH	£14 (carr. £1.50)
DOUBLE MASTER PLINTH	£25 (carr. £2.00)

Continued →

COMPUTER CONCEPT'S ROMS

ACCELERATOR	£48
CARETAKER Basic Utility	£27
Graphics ROM	£23
Disc Doctor ROM	£24
TERMI	£27
COMMUNICATOR	£49
SPEECH ROM	£24
Printmaster	£24

Wordwise £25

Wordwise plus

£40

We are giving away absolutely **FREE**, the superb Word-Aid ROM worth £24, with every WORDWISE PLUS package bought from us.

Word-Aid

The most comprehensive utilities ROM for Wordwise-Plus

Extend the power of your Wordwise Plus word processor with this most advanced ROM from Watford. By utilising the powerful Wordwise Plus programming language, WordAid provides a whole host of extra features, all accessed via a special new menu option. This ROM has been personally approved by Mr Charles Moir, the author of WORDWISE PLUS.

- Alphabetical sorting of names and addresses.
- Text transfer options.
- Chapter marker.
- Epson printer codes function key option.
- Search and display in preview mode.
- Embedded command removal.
- Print Multiple copies of a document.
- Multiple file options for print and preview.
- Address finder.
- Label printer.
- Mail-merger.
- Number/delete/renumber.
- Clear text/segment area.
- BBC B, B+ and Master compatible.

Only £24

(N.B. Word Aid requires a Disc Interface in your Micro)

HI-WORDWISE-PLUS

Supplied on disc. This version requires a WORDWISE-PLUS ROM to be present in the machine. It gives up to 44k of text space on the 3502 2nd processor.

£5

Inter SHEET £40

INTER-CHART ONLY: £26

Computer Concepts' long awaited

Inter-WORD

Only: £49

Special price to Wordwise Plus owners. Please quote your reg. number and pay.

Only: £39

All Prices Exclusive of VAT

32K SHADOW RAM-Printer Buffer Expansion Board

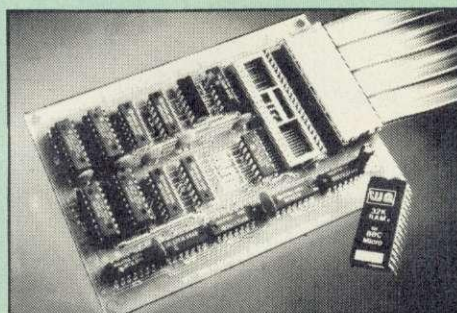

A MUST FOR WORD PROCESSING

Watford Electronics now brings you the latest state-of-the-art MEMORY EXPANSION BOARD for your BBC microcomputer. Don't throw away your BBC B for a BBC B+ or BBC Master. Just plug the ribbon cable into the 6502 processor socket, and fit the compact board inside the computer. Immediately you will gain not 16K or even 20K, but a massive 32K of extra RAM!!!

● IMPROVE your WORD PROCESSING system, whether disc or cassette based. Don't wait for a slow printer – type in text while printing. TWO JOBS DONE SIMULTANEOUSLY and £100+ saved on a printer buffer.

● "VIEW" Wordprocessor users can now type in letters in 80 columns and have up to 28,000 bytes free – 5 times as much as normal.

● In WORDWISE (or WORDWISE-PLUS), preview in 80 columns with the full 24K of text in memory. This product is recommended as an ideal complement by Computer Concepts.

● Combine GOOD GRAPHICS and LONG PROGRAMS. Use the top 20K of the expansion RAM as the screen display memory, leaving all the standard BBC RAM free for programs. Benefit from MODE 0/1/2 graphics and 28K of program space.

● Use the FULL 32K or the bottom 12K of the expansion RAM as a PRINTER buffer for PARALLEL or SERIAL printers, sound channels, RS423 etc. Print large text files while running long graphics programs, and have all your buffer options available as well (*FX15,21,138,145,ADVAL etc). Please note only a 12K printer buffer can be used with Wordwise or Wordwise-Plus, due to the way they are written.

● Ensure COMPATIBILITY with a vast range of hardware (including our ROM board, the ATPL ROM boards, double density boards, second processors), and software (including BASIC, TOOLKIT, VIEW, WORDWISE (1.20+), WORDWISE-PLUS, Music 500's AMPLE). This is because our board, unlike those of our competitors, is connected to the computer by a ribbon cable and has the power consumption of a couple of ROMs!

● Achieve EASY OPERATION with ROM based software. A large range of commands is available for machine code and BASIC users, including some useful *HELP messages, and a comprehensive manual is supplied free.

● Unique facility to turn ROMs off and on again. Unlike all other ROM managers, this feature does not use 'unofficial' memory. Two bytes of normally user-inaccessible memory on the RAM card are used to ensure ROMs are disabled WHERE OTHER ROMS FAIL.

Only: £59 (carr £2)

(Price includes a comprehensive manual and the ROM)

INCREDIBLE WORD PROCESSING DEAL !!!

Watford Electronics, already renowned for quality products at discount prices, are offering, the truly spectacular BARGAIN OF THE YEAR!

A Watford's 32K RAM Card (offering printer buffering and shadow screen RAM facilities) with the well known WORDWISE PLUS Word processor.

32K Shadow RAM Card/Printer Buffer and Wordwise Plus (a very powerful package) for the absolutely astounding price of:

Only £75 (carr £2)

(P.S. For an extra £14, we will include Word-Aid ROM package for the Wordwise Plus, if bought at the same time.)

VIEW

VIEW WORDPROCESSOR 2.1 £37

VIEW 3.0 ROM

Price: Only £56

HI-VIEW

A special version of VIEW designed for use with 6502 2nd Processor. Available on disc, it offers 47K of text memory.

£36

VIEWSHEET (Acornsoft) £37

VIEWSTORE £37

VIEWSPELL £50

VIEWPLOT Disc £25

Watford's own Sophisticated VIEW PRINTER DRIVER for Epson FX80 & KAGA KP

Only £10

VIEW DRIVERS FOR JUKI & BROTHER HR15 PRINTERS

Only £10

VIEW/VIEW SHEET PRINTER DRIVER for SILVER REED
(Officially approved by Silver Reed)

Only: £10

SPECIAL OFFER

Acorn's Speech Synthesiser Package

Complete with manual in its original packaging

Clearance price Only: £19



ARIES CORNER

Aries Computers was the first company to commercially market what is now known as SHADOW RAM. As part of its continued expansion policy, Watford Electronics is proud to announce that the Aries range is now available exclusively from Watford Electronics and their dealers.

The Aries range, designed by experts offers you the solution to your upgrade nightmares. All the Aries products are compatible with double density disc controllers, modems, second processors, ECONET, hard discs, EPROM programmers and of course, other members of the Aries family and most of the much wider Watford family (some products advertised here perform identical functions and hence cannot be used together). Several major companies now test all their products to ensure compatibility with the Aries B20 & B32.

In quality of construction, the Aries range sits alongside the Watford range in setting a standard against which others are judged. Custom made connectors eliminate the damage to the BBC machine caused by inferior products.

The Aries B-32 Shadow RAM Card

18 months of intensive research and development have produced a worthy successor to the widely acclaimed Aries-B20; the revolutionary Aries-B32. This 'second generation' expansion board features 32k of RAM and a 16k ROM socket.

Like the BBC B+, the B32 provides 20k of shadow screen RAM and 12k of sideways RAM. Unlike the B+, the B32 has simple software commands which allow the user to reconfigure the RAM as 16k of shadow RAM and 16k of sideways RAM, or all 32k as sideways RAM.

With the B32, the programmer gets up to 28k of RAM available for Basic, Logo, Comal, Forth, Lisp and BCPL programs in any screen mode. The business user gets extra memory for View, ViewSheet, Wordwise Plus and many other applications. For advanced applications, the scientific user gets access to a massive 47k of data storage using the Acorn approved *FX call.

Sideways RAM enables you to load sideways ROM images from disc, allowing you to have a large library of sideways ROMs (subject to the copyright holder's permission) stored on disc. The B32's sideways RAM can also be used to extend any operating system buffer (such as the printer buffer) or to load tape programs into a disc system.

The B32 simply plugs into the processor socket on your BBC micro - no flying leads to connect and no soldering. Provision of the on-board ROM socket means that the Aries-B32 control ROM does not use up one of your existing ROM sockets.

Price: B-32 £80 (carr. £2)

Aries B-12 Sideways ROM Board

This board is extremely well made, simple to install, reliable when fully loaded and compatible with the Aries B-20 and the Aries B-32. For the business user or educationalist, the compact and secure internal fitting is ideal, with the ROM board tucked neatly inside the lid where it will not cause overheating problems. The serious software developer and the hobbyist may prefer to mount the board externally, giving instant access to the sockets for experimental purposes. A zero-insertion force (ZIF) socket may be fitted to the board to enhance this mode of operation. The B12 provides a total of twelve

sideways ROM sockets (the four in the original machine are replaced by the twelve on the board), all fully accessible by the MOS sideways ROM system. In addition, there are two sockets for sideways RAM, giving up to 16k of RAM using 6264 static RAM chips.

The B12 system consists of two parts: a large detachable 'mother board' which carries the extension ROM sockets and a small 'base board' on a short ribbon cable, which plugs into the existing sideways ROM sockets. This two-board design eliminates the reliability problems previously associated with some other ribbon-cable based systems.

If you do not have an B32 or B20, a small adaptor module (the Aries B-12C) is available at a nominal cost. The 6264 static RAM chips used to provide the sideways RAM are advertised elsewhere in our advert.

Price:
Aries B-12 £40. Aries B-12C £5

THE ARIES B-488 IEEE-488 INTERFACE UNIT

The Aries-B488 is an interface unit to enable the BBC micro to control and monitor IEEE-488 bus systems. The IEEE-488 bus (also known as the 'GPIB' or 'HP-IB') is the standard method of interconnecting programmable laboratory instruments and control equipment. Using the B488, up to 15 devices may be connected in a single high-speed data network.

Aries B-488 Unit: £238 (Carr
£3)

THE ARIES RANGE HARDWARE REQUIREMENTS

Aries B-32 - BBC B, MOS 1.20, hardware plugs into CPU socket.

Aries B-12 - BBC B, MOS 1.20, hardware plugs into all four sideways ROM sockets and connects to the B32 or the B20. The adaptor Aries B-12C module is necessary where these are not fitted.

Aries B-488 BBC B, MOS 1.20, Hardware plugs into 1MHz Bus.



**CREDIT CARD 24 HOUR
Ansaphone Hot Lines
(0923) 50234/33383**



النور ARABIC ROM for the BBC Micro

The ALNOOR ARABIC ROM converts your BBC into a bilingual computer. New keytops provide both English and Arabic symbols. Two sets of Arabic symbols are provided for use in either context sensitive or insensitive operation.

20, 40 and 80 column operation. Compatible with ASMO (449). English/Arabic printer interface software. Numeric entry from either left or right of number. Communications software to send or receive 7 or 8 bit data.

Different shapes of Vowels (e.g. Shadda, Fatha, etc). Different shapes of Hamza. Full English and Arabic character sets with all special characters.

£85

(Price includes Alnoor ROM, Operating Manuals & a full set of Arabic/English Keytops)

OFFICE MATE

Database - Set up a computerised "card index" system and add record/data to the file your way. Features include search, sort, mathematical calculations, printer routines, data summaries, etc.

SPREADSHEET - Offers a wide range of invaluable calculation and editing features. Beebplot will take files created by Beebcalc to provide data portrayal in graph, histogram or pie chart format.

BEEBLOT - Provides an easily assimilated visual representation of numerical data.

WORDPROCESSOR - Provides many routines found in large and expensive packages.

OFFICE MATE Only £10
(Cassette or Disc)

OFFICE MASTER

CASHBOOK - A complete "Stand Alone" accounting software package for the cash based sole trader/partnership business. It is designed to replace your existing cashbook system and will provide you with a computerised system complete to trail balance.

FINAL ACCOUNTS - Will take data prepared by the Cashbook module and produce a complete set of accounts as following: Trial Balance with inbuilt rounding routine; Notes to the accounts; VAT Summary; Profit & Loss A/C; Balance Sheet.

MAILIST - A very versatile program. Enables you to keep records of names and addresses and then print, examine, sort and find them, all with special selection techniques.

EASILEDGER - A management aid software tool designed to run alongside an existing accounting system. Essentially a Debit/Credit ledger system which can handle sales, purchase and nominal ledger routines to provide instant management information.

INVOICES & STATEMENTS - Greatly reduces the time and cost of preparing Invoices and Statements by storing essential information like customer names, addresses and account numbers. Has VAT routines and footer messages facility.

STOCK CONTROL - Allows you to enter stock received, stock out, summary of stock items and current holdings together with details of total cost, total stock value, current gross margin, cost of bringing stock to minimum level, units in stock ordering, quantity and supplier detail.

All this for only £21
(Cassette or Disc)

Money Management

This disc based software allows individual transactions to be stored and retrieved for upto 5 Bank a/c and 5 Loan accounts.

Price: Only £11

L.B.O. Rom

Life & Business Organiser

Use LBO to organise your life from today until 1999! It can handle literally hundreds of multi-line messages, as many as you are ever likely to need. Despite the very wide range of facilities offered, this professional program is VERY easy to use and requires absolutely NO knowledge of computers. A vital aid to your everyday life, LBO is GREAT FUN TO USE!

Price only: £17

DDD Suite Integrated Software System

-BASE £15
-CALC £15
-PLOT £15

COMBO PACK All 3 together £36

Continued



BOOKS (No VAT on Books)

30 Hour BASIC (BBC Micro)	£7.95
40 Best machine Code Routines	£7.95
6502 Assembly Language Program	£19.95
6502 Application	£11.95
6502 Assembly Lang. Subroutines	£19.95
6502 Development System	£7.50
68000 Assembly Lang. Programming	£19.95
68000 Machine Code Programming	£12.95
68000 Programming the	£22.95
6809, Programming the	£16.95
A User Guide to Wordwise Plus	£9.95
A Young persons Guide to	
BBC Basic	£5.95
Advanced Disc User Guide	£14.95
Advanced BASIC ROM User Guide	£9.95
Advanced Machine Code Technique	
for BBC	£7.95
Advanced Programming for BBC	£6.95
Advanced User Guide for BBC	£13.50
Advanced Graphics with BBC	£9.95
Assembly Language Programming on	
BBC Micro	£11.50
Advanced Programming Techniques	
for the BBC Micro	£8.95
Adventure into BBC BASIC	£6.95
Applied Assembly Lang. for BBC	£9.95
Assembler Routines for the 6502	£7.95
Assembly Language Programming FOR the	
BBC Micro	£9.95
Assembly Language Programming on the	
BBC & Electron	£8.95
Basic Programming on the BBC Micro	£6.95
Basic ROM User Guide	£11.95
Basic User Guide for BBC Micro	£10.00
BBC B+ User Guide	£14.95
BBC BASIC	£5.95
BBC Forth	£7.50
BBC Machine Code Portfolio	£7.95
BBC Master 128 High Flyer	£10.95
BBC Micro Advanced Ref. Guide	£10.95
BBC Micro Advanced	
Programming	£9.95
BBC Micro Book BASIC Sound &	
Graphics	£7.95
BBC Micro ROM Book	£9.95
BBC Micro Disc Companion	£8.95
BBC User Guide	£10.00
BCPL User Guide	£14
Complete FORTH	£6.95
CP/M - 86 User's Guide	£19.95
CP/M Bible	£16.50
CP/M Handbook with MPM	£9.95
CP/M Plus Handbook	£13.95
CP/M Soul of	£16.50
CP/M The software BUS	£8.95
Creative Animation & Graphics	£7.95
Creative graphics on BBC Micro	£7.50
Disc Drive Projects for Micros	£5.45
DISC FILING SYSTEM (DFS)	
Operating Manual for BBC	£6.95
Disc Programming Techniques	£9.95
Discovering BBC Micro Machine Code	£6.95
Disc System for the BBC Micro	£6.95
Exploring FORTH	£6.95
FORTH on the BBC Micro	£7.50
Functional Forth for the BBC Micro	£5.95
Games BBC Micro Play	£6.95
Graphics for Children	£6.95
Graphs & Charts on BBC Micro	£7.50
Guide to BBC ROM	£9.95
Hackers Handbook	£4.95
Hackers Handbook - New	£6.95
Handbook of Procedure & Functions for the	
BBC Micro	£6.95
Interfacing & Robotics on BBC	£15.95
Interfacing Your BBC Micro	£8.95
Into View	£4.50
Introduction to COMAL	£9.50
Introduction to LOGO	£6.95
Introducing 'C'	£9.95
Introducing CP/M on the BBC Micro	Z80
2nd Processor	£9.95
Introducing LOGO	£5.95
Introduction to FORTH	£8.95
Introduction to PASCAL	£17.95
ISO -PASCAL Reference Manual	£9.95
Let your BBC teach u to program	£5.45
LISP 2nd Edition	£14.95
LISP, A Beginners Guide to	£10.95
Logo Programming	£9.95
Mysteries of DISC DRIVES and DFS	
REVEALED	£5.95

Mastering CP/M	£17.95
Master Advance Reference Manual	£19.95
Master Reference Manual Part 1	£14.95
Master Reference Manual Part 2	£14.95
Micronet Handbook	£6.95
Programming the 6502	£16.95
Programming the Z80	£19.95
Sencing & Control Projects for BBC	£5.95
S-PASCAL on BBC Micro	£7.50
Structured Basic	£7.95
Structured Prog. with BBC BASIC	£6.50
Termlator Manual	£4.95
The Complete FORTH	£6.95
The Complete Programmer	£5.95
The Epson FX/KAGA PRINTER	
Commands REVEALED	£5.95
Turtle Graphics on BBC Micro	£7.50
Using Floppy Discs with BBC Micro	£5.95
View 3.0 User Guide	£10
View Guide	£4.50
Viewsheet User Guide	£10
Viewstore User Guide	£10
Using BBC Basic	£4.95
Wordprocessing BBC Beginners Guide	£7.95
Wordstar & CP/M made easy	£7.45
Wordwise Plus Guide	£9.95
Z80 Assembly Language	
Programming	£19.95

EPROM PROGRAMMER

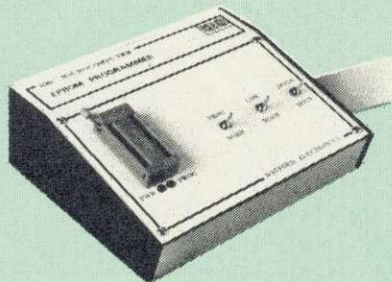

The Watford Electronics' EPROM programmer for the BBC micro is a high quality self contained package. Programs all popular EPROMs from 2K to 16K: 2716, 2516, 2532, 2564, 2764 and 27128. All manufacturers' specifications have been followed to program EPROMs at the correct speed - wrong timings could destroy your EPROMs. The unit has its own power supply so does not put heavy loads on the BBC power supply as do some other units. Connects directly to the 1MHz bus following all Acorn recommendations on addressing and bus loadings.

SOFTWARE PACKAGE

The software is supplied on an EPROM which plugs into the Micro and is instantly available with a single command (no time wasting as on Cassette/disc loading). It is a fully purpose designed and integrated package to simplify ROM development. The system is menu driven with many prompts to avoid any accidents.

Software facilities include:

Load File - Save File - Down Load EPROM - Program EPROM - Verify - Blank Check - Editing of memory contents prior to programming.
Also included is an automatic system to allow Basic programs to be put in EPROM and accessed through the *ROM filing system. More than one program may be put in an EPROM. All these facilities and more are explained in the comprehensive and clear 15 page manual.

SPECIAL OFFER £69 (£3 carr.)

TEX EPROM ERASERS

EPROMs need careful treatment if they are to survive their expected lifetime. Over erasure of EPROMs very rapidly turns them into ROMs! The TEX erasers operate following the manufacturers specifications to give the maximum possible working life by not erasing too fast. We use these erasers for all our own erasing work.

- **ERASER EB** - Standard version erases up to 16 chips. **£28 (carr £2)**
- **ERASER GT** - Deluxe version erases up to 18 chips. Has automatic safety cut-off to switch off the UV lamp when opened. **£30 (carr £2)**
- Spare UV tubes. **£9**

BEEB VIDEO DIGITISER

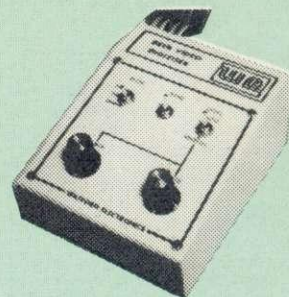

Using any source of composite video (colour or monochrome) and the Watford Beeb Video Digitiser, you can convert an image from your camera into a graphics screen on the BBC Micro. This uses the full graphics capacity of the BBC micro in modes 0, 1 or 2. The video source may be a camera, video recorder or television, and is connected via the video output socket.

Images produced can be compressed, stored to disc, printed on an Epson compatible printer, directly used to generate graphics, analysed for scientific and educational use or converted to other formats e.g. Slow Scan TV or receiving a picture from a remote camera using a modem.

The output from the digitiser exactly matches the graphics capability in each mode, with up to 8 levels of grey in mode 2. The unit connects into the User Port and automatically scans a complete picture in 1.6 seconds.

Both the black and white levels can be adjusted manually for the optimum picture, or switched to automatic for unattended use. The image produced can be reversed if necessary.

Full controlling software is supplied on a normal sideways ROM and this is easily accessed via additional * commands. The package is designed to allow easy input of complex screens and give full access of the data to the user. Once on the screen, the image can be used as a normal graphics screen, allowing any of the usual graphics commands in BASIC or other ROM's to work on it.

A special print dump routine is included with the driver programs. This is specially designed to produce a fast, correctly proportioned picture, with reduced "contouring", resulting in an accurate reproduction of the original image.

Detailed examples of driving this unit from BASIC or other languages are all provided in the extensive manual supplied.

£110 (Carr. £3)

(Price includes: Digitiser Unit, Software in ROM & a Comprehensive Manual)
(BBC B+ and Master compatible, except Master with Econet)

Magazine Maker

(As seen on TV)

A combination of the AMX Pagemaker and Watford's Beeb Video Digitiser.

Using any video that provides a composite signal and the digitiser, images from a camera or TV can be converted into a graphics screen on the BBC Micro.

They can then be used within AMX Pagemaker to illustrate magazines or newsletters - in fact anything that needs to be created on A4 size paper.

With Pagemaker's many features, a variety of pictures can be composed - the only limit being the imagination.

Pictures can be doctored using Pagemaker's graphics option to produce any number of effects.

Text can be formatted around the digitised photo on screen using the facilities available, which include 16 typefaces, character and pattern definer, text formatting and the ability to load in wordwise and viewfiles plus much more.

Once created the picture can be printed out. The Magazine Maker is suitable for any use that requires illustrated documents.

Complete Package £129.00 (carr. £3)

VOLTMACE JOYSTICKS

Delta 3B Single Joystick	£10
Delta 3B Twin Joysticks	£16
Delta 14B Single Joystick	£12
Delta 14B/1 Adaptor Module	£12
Transfer Software Disc/Tape	£7

ROM EXTRACTION TOOL

This extremely useful tool allows you trouble free chip removal from your computer by distributing the removal force over the whole body of any 24 or 28 pin chip.

Price: **£2**

SURGE PROTECTOR Plug

Fitted in place of your normal mains plug, this device protects your equipment against mains surges. Nearby lightning strikes, thermostats switching and many other sources put high voltage transient spikes on to the mains. This can lead to data corruption in memory and on disc and can result in spuriously crashing machines. A must for every computer user.

Protection for only **£8.75**

ATTACHE CARRYING CASE for BBC Micro

The Attache carrying case is attractively finished in mottled antique brown leatherette. The case is made of tough plywood, providing a very solid and safe way to carry your BBC micro. There is room provided to fit all the leads necessary behind the computer and manuals in the front. Locks supplied with two keys. Price **£13** (£2 carr.)

28 pin ZIF SOCKET (Textool) **£6.95**

28pin DIL HEADER PLUG

SOLDER type	£1.50
IDC CRIMP type	£1.95

SPARES for BBC Micro

Keyboard	£46	Keystrip	£2
UHF Modulator	£4	Case	£25
Speaker Grill	£1	Speaker	£2
Power Supply	59	Keyswitch	£1.50

Replacement FLEXIBLE KEYBOARD CONNECTOR
£3

8way DIP SWITCH **£0.85**

CONNECTING LEADS

(All ready made and tested)

CASSETTE LEADS 7 pin DIN Plug to 5 pin DIN Plug + 1 Jack Plug	£2.00
to 3 pin DIN Plug + 1 Jack Plug	£2.00
to 7 pin DIN Plug	£2.50
to 3 Jack Plugs	£2.00
6 pin DIN to 6 pin DIN Plug (RGB)	£2.50

DISC DRIVE POWER LEADS

Supply from BBC power supply to standard Disc Drive connector.

Single **£3.00** Dual **£3.75**

DISC DRIVE INTERFACE LEADS

BBC to Disc Drives Ribbon Cable
Single **£4** Twin **£6**

MISCELLANEOUS CONNECTORS

	Plugs	Sockets
RGB (6 PIN DIN)	30p	45p
RS423 (5 pin Domino)	40p	50p
Cassette (7 pin DIN)	25p	65p
ECONET (5 pin DIN)	20p	30p
Paddles (15 pin 'D')	80p	200p
BBC Power Plug 6 way	80p	-
Disc Drive Plug 4 way	75p	-
BBC Power Socket 6 way	80p	95p

Watford Electronics' Dealer's List

UNITED KINGDOM

Akhter Instruments Ltd, Akhter House, Perry Road, HARLOW, Essex

BEEBUG, Dolphin Place, Holywell Hill, St. Albans, Herts

Cambridge Computer Store, 1 Emmanuel Street, Cambridge

Citkit Distribution Ltd, Park Lane, Broxbourne, Herts.

Dennis Spitz Computers Inc, 86 Golders Green Road, London NW11

Greenbank Electronics, 92 New Chester Road, New Ferry, Wirral, Merseyside

Gemini Marketing Ltd, Exmouth, Devon

Microman Computers, Rainford Industrial Estate, Mill Lane, Rainford, St. Helens

Peartree Computers Ltd, Falcon House, High Street, Huntingdon, Cambs.

Twilstar Computers Ltd, Apex House, Blandford Road, Norwood Green, Southall

Verospeed Ltd, Boyatt Wood, Eastleigh, Hants.

OVERSEAS DEALERS

Absolute Electronics, 483 Centre Road, Bentleigh, Victoria, Australia 3204

Alpha Computer Co, Shop 314 Chi Fu Commercial Centre, Chi Fu Fa Yuen, Hong Kong, Tel: 5-506592

Computer Distribution Company, Parklaan, 47, B-9300 Aalst, Belgium

ECD BV, Voldersgracht 26, 2611 EV Delft, Holland

LENDAC DATA SYSTEMS, 8 Dawson Street, Dublin 2, Ireland

Scientex P.V.B.S., Zilvermidstraat 2, B-2000 Antwerpen, Belgium, Tel: 03 233 59 06

Techno-Matic Data, Holbergsgade 19, 1057 København K, Denmark

Velobyte, Scheaedyksadyk 5A, 3011 EB Rotterdam, Holland, Tel: 4138197

Viking Tecno, Vestergade 12.1, 9620 Aalestrup, Denmark, Tel: 08 642522

4 WAY MAINS DISTRIBUTION SOCKET

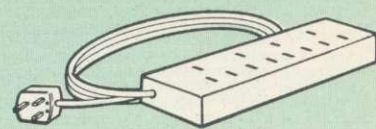

4 way top quality mains trailing sockets. Supplied wired up with mains plug ready for use. Can be screwed to floor or wall if required. Very useful for tidying up all the mains leads from your peripherals. Allows the whole system to be switched on from one plug. **£9.50** (carr £1.50)

ACORN MUSIC 500

The Acorn Music 500 System is probably the most powerful piece of music generating hardware available for the BBC Micro.

£72 (carr £4)

Software Disc 'Mu-500' has 13 tunes **Only: £6**

CHIP SHOP

8271	£36	Acorn BCPL	£42
DS3691	£3.50	BCPL Calc Pack ...	£15
DS88LS120	£3.00	BCPL Stand Alone	£36
LM324	£0.45	Generator	£25
SN76489	£5.50	Basic Editor	£28
SAA5050	£8.75	BROM	£20
UPD7002	£4.40	Buffer & Backup ...	£22
2764-250nS	£2.00	Beebmon	£25
27128-250nS	£2.50	Beebfont	£36
27512	£18	Acorn COMAL	£32
4013	60p	Acorn FORTH	£25
4020	£0.90	Acorn Graphics	£21
4464	£8	Graphics Extension Rom	£21
4816 RAM	£1.75	GXR-B	£22
6264LP-8K RAM	£3.00	GXR-B+	£35
6502A CPU	£5	Acorn LISP	£42
65C02 CMOS	£10.00	Acorn LOGO	£42
65C12	£9	ISO Pascal	£30
6512A	£10.00	ISO-Pascal Stand	£28
6522	£3.40	Alone Generator ...	£52
6522A	£5.00	ICON Master	£62
6845SP	£6.00	Logotron LOGO	£48
7438	40p	Micro Prolog	£29
74LS00	25p	Microtext ROM	£13
74LS04	25p	ROMIT	£15
74LS10	25p	Serial ULA	£25
74LS123	80p	Video ULA	£21
74LS163	70p	TERMULATOR	£24
74LS244	80p	MUR0M	£18
74LS245	£1.00	SLEUTH ROM	£31
74LS373	£1.00	STUDIO 8 Disc	£49
74LS393	£1.00	Toolkit Plus	£16
75453	70p	Communicator	£27

ASSORTED ROMS

ACORN BASIC 2 ...	£19
ACORN ADFS	£25
ACORN DNFS	£17
ACORN OS 1.2	£6
Acorn OS B+	£25

Prices subject to change without notice and available on request. ALL OFFERS subject to availability.

Mail Order and RETAIL SHOP. Trade and Export inquiries welcome. Government and Educational Establishments' OFFICIAL ORDERS Accepted.

Shop Hours: 9.00am to 6.00pm. Monday to Saturday. Thursdays 9am to 8pm. (Free Customer's Car Park)

VAT: UK customers please add 15% VAT to cost incl. Carriage.

CARRIAGE: Unless stated otherwise, minimum £1 on all orders. £2 on Larger items. On bulkier items, £7 Securicor charge applies. Overseas orders, carriage is charged at cost.

Specifications of all products are given in good faith but is subject to change without notice. Some items vary in their availability. Please ring for latest delivery situation.

Watford Electronics
JESSA HOUSE, 250, Lower High Street, WATFORD, ENGLAND
Telephone: (0923) 37774; Telex: 8956095 WATFRD

Does it make sense to buy a disc drive . . . and load most of your programs from Tape?

In a world where time is money and delay is frustration, the **REPLAY** System can bring taped software into the disc era. There is no other way of transferring software to disc that is so effective and efficient as **REPLAY**. Thousands have now been sold and acclaimed by the users as indispensable.

REPLAY is more than a transfer utility . . .

REPLAY captures the computer's memory and stores it in disc form at virtually any point, whether the original program has been loaded from tape, disc or personal endeavour.

REPLAY can reload a selected screen from disc, ready for printing out to a hard copy.

REPLAY can effect a simple 'pause' or save a partly completed program to disc for later use.

REPLAY is 'encoded' in order that programs transferred to disc are individual to, and can only be run by, the same computer.

Get more enjoyment and action out of your software with the **REPLAY** System.

East to fit with no soldering, uses one sideways ROM socket with three simple connections in to the computer.

REPLAY must be matched to the DFS IN USE:

R8271 - Acorn 8271, also S.D. Watford and Pace DFS.
 R8272 - U.D.M. DFS
 R1770 - Opus 3.45 DFS and Solidisk Issue 1.
 R1770A - Acorn 1770 DFS and ADFS, also Solidisk Issue 2.
 R1770B+ - for BBC 'B+' only.
 R1770W - Watford DDFS only.
 R2793 - Opus 3.35 only.
 R8877 - Cumana QFS.
 R1770C - Opus Challenger only.
 R2791 - Opus 3.15 only.
 (Acorn 'Master' in preparation).

Price **£35.00** (incl. VAT), with full instructions for installation and use

Further details and reviews available

New product "Master" Write-Protect Switch. A small module that fits inside the Master computer which enables you to write-protect the Sideways RAM banks. Available NOW priced at **£8.95** inc. **NEW RELEASE** "B+" to "B" conversion kit for increasing the number of programs usable on a B+. POA. For further details or supply contact:

VINE MICROS, MARSHBOROUGH, NR. SANDWICH, KENT CT13 0PG. (Tel: 0304 812276)

or through your local Dealer

The Matrix ROM

The **MATRIX ROM** is an essential tool for Science and Mathematics Departments in schools, for Science, Computing and Engineering Departments in Universities and Polytechnics, and for anyone who writes serious programs for industrial applications. Written with the cooperation of the Civil Engineering department of Southampton University.

The **MATRIX ROM** provides a comprehensive range of commands for performing matrix operations (including inversion). One of the many commands will solve a set of linear simultaneous equations, and another deals with sets of banded symmetrical equations. In addition there are commands for deleting and redimensioning arrays (to re-use valuable memory space), for finding maximum and minimum values in any row or column, and for inputting, saving, loading and printing arrays. All commands are executed in machine code much more quickly than is possible in **BASIC**. Many lines of coding can be eliminated and much memory space can be saved.

These facilities transform the capability of the BBC Micro when dealing with tasks such as graphical transformations in two or three dimensions, or structural analysis, electrical circuits or vibration problems. In fact any problem where matrix operations or linear simultaneous equations are involved. The power of **FORTRAN** can now be combined with the simplicity of **BASIC** and the excellent graphics of the BBC micro.

Suitable for the BBC 'B', 'B+' and ELECTRON COMPUTERS

£36.00 (plus VAT), includes comprehensive Manual

Quantity discount offered to Educational Establishments

Further details available on request



by



AA186

SOFTWARE	Suitable for standard and Master Series computers	
	CASHBOOK Double Entry bookkeeping in RAM	£13.75
	CASHBOOK Double Entry random access bookkeeping	£22.95
****	ACCOUNT Double Entry random access bookkeeping with credit control, ledgers and analysis for businesses	£34.45
	MAILING 250 names/addresses, label printing for clubs	£13.75
****	MAILING 1100/2500 names/addresses for label printing with mail merge for any wordprocessor for businesses	£34.45
****	PAYROLL system with 1, 2, 4 weekly & monthly, contracted in & out, 3 overtime, personnel file, 2 payslip formats	£57.50
****	SPECIAL OFFER (THREE 4 * programs)	£69.95
	FAMILY TREE 250 records for Ancestral, descendant and genealogical tracing with full tree printout	£19.95
	STATPACK the stats package for students	£13.75
ROMS	WORDWISE PLUS "Selling more than others"	£51.75
	INTERWORD "The new genius wordprocessor"	£54.05
	DISC DOCTOR UTILITY "Still the best"	£29.90
	PRINTMASTER UTILITY "Not redundant yet"	£31.05
	INTER CHART DATA DISPLAY "Quite clever"	£34.50
	INTER SHEET SPREADSHEET "Not bad"	£51.75
	CARETAKER UTILITY "We use it so it must be good"	£29.80
EPROMS	27128 16k = £2.75 27256 32k = £4.95	
	UVIPAC PROGRAMMER 8016K	£2.00
PRINTERS	Citizen 120D + NLQ 120 cps Friction + Tractor	£225.00
	Centronics GLP II 100 cps NLQ Friction + Tractor	£189.95
	Cartridge printer ribbons (various types)	£5.50
PRINTER CABLE	Suitable for BBC/Electron to Parallel Printers	£8.95
DISC DRIVE	Opus twin double sided 40/80 without power supply	£189.95
DISCS	5.25" Double sided double density 80 tracks in box	£10.95
CASSETTES	C15 boxed in 5's, leaderless, ideal data tapes	10 for £2.50
LISTING PAPER	Box 2000 sheets 11" x 9.5"	£12.95
LABELS	For Mailing, 1000 3 across 2.75" x 1.4375"	£6.50
	1000 1 across 3.5" x 1.4375"	£6.50
	2000 2 across 3.5" x 1.4375"	£11.95

Ask for brochure for more software and further details.

Prices include VAT. Add 50p for Postage & Packing. Discs add 98p, Printers add £8.50

Micro-Aid



(AU),
25 Fore Street, Praze, Camborne,
Cornwall TR14 0JX
or Telephone 0209-831274 with ACCESS
or PRESTEL *2582020

MICRO-TRADER

INTEGRATED SALES PURCHASE AND NOMINAL LEDGERS

Designed for business use by a business man programmer. MICRO-TRADER is a fully integrated program in which all **Sales and Purchase Ledger** transactions are automatically updated to the **Nominal Ledger**.

MICRO-TRADER offers full Sales and Purchase ledger facilities including **SALES INVOICE** and **STATEMENT PRINTING** with a capacity of **450 accounts and 3000 transactions per month in each Ledger**.

Normal Income Expenditure, Assets, Liabilities & Journal Posting in the Nominal Ledger with full Reporting for individual accounts, Audit Trail, Trial Balance, Profit & Loss and Balance Sheet.

This suite is the only accounts package a real business needs to keep, maintain and finalise its accounts. If you are seriously in business consider how much time and money you spend and lose because you are not an accountant. You are a businessman and so am I. You have a computer and so have I, all you need is MICRO-TRADER to let you get on with running your business. I have already got it.

MICRO-STOCK would be an asset if you purchase goods in your business. It is a **Stock Control** program, fully integrated with MICRO-TRADER. **4000 Stock Items with user defined codes. Invoice and Credit Notes and Cash Sale routine. Full Stock Held Reports.**

If you have staff let EXTENDED PAYROLL solve the wages problem. We have been supplying payroll programs for a year longer than anybody else for the BBC and people trust us.

MICRO-TRADER £200 - MICRO-STOCK £95.00 - EXTENDED PAYROLL £49.95 (+ VAT)

Ring **Colin Chatfield**, Fellow of the Institute of Analysts and Programmers for more information. He will be pleased to advise which, if any, of these programs you need.

To the trade: If you are interested in selling the best business programs for the BBC you could do worse than ring us.

AA291

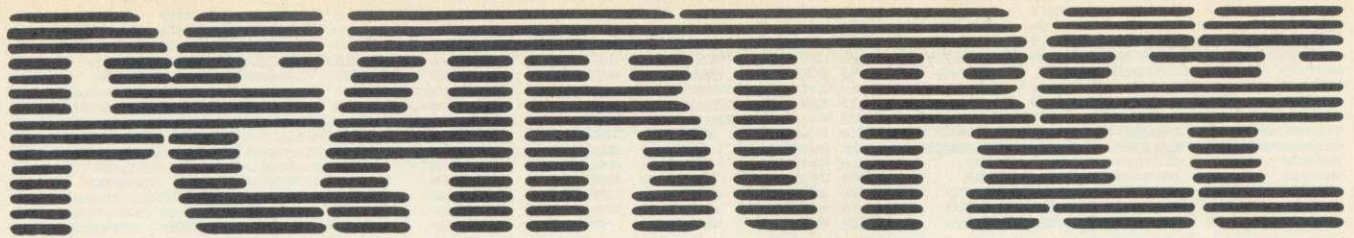

AUTHORISED ACORN DEALER

HARDWARE

AMB15 BBC MASTER 128	£395.00
<ul style="list-style-type: none"> * 128K * Complete with View, Viewsheets, A Basic editor, Termulator, ADFS, 1770 DFS and Basic * Battery backed up RAM * Two ROM cartridge sockets * Numeric keypad 	
ANB55 BBC B+ 128K	£385.00
<ul style="list-style-type: none"> * 64K BBC Basic * Sideways RAM * 1770 DFS 	
ANB03 BBC B INC DFS	£299.00
<ul style="list-style-type: none"> * 32K computer * Includes Acorn DFS 	
ADC06 TURBO UPGRADE FOR MASTER	£120.00
<ul style="list-style-type: none"> * 65C102 second processor * 4MHZ * 64K RAM * Hi-Basic * Hi-Editor * Printer buffer software 	
PTC5000 MUSIC 5000	£140.00
<ul style="list-style-type: none"> * Compatible with BBC B, B+ and Master * Complete with Ample on ROM * Multi user-friendly input modes for ease of use * 16 channels * Includes a step-by-step beginners guide 	
ADF13 ROM CARTRIDGE	£13.00
<ul style="list-style-type: none"> * Takes existing ROM software in cartridge form * Cuts down opening of machine to insert ROMs 	
ANB28 1770 DFS UPGRADE FOR BBC B	£39.00
<ul style="list-style-type: none"> * Allows BBC to access disc drives * Will take ADFS for double density 	
ANB29 ADFS ROM FOR 1770 OR BBC B+	£23.00
<ul style="list-style-type: none"> * For use with BBC B+ * For BBC B with 1770 DFS kit * Double density * Hierarchical filing structure 	
ANB27 64K UPGRADE KIT FOR B+	£35.00
<ul style="list-style-type: none"> * Upgrades B+ to 128K * Sideways RAM 	
ANC06 32016 CO-PROCESSOR	£999.00
<ul style="list-style-type: none"> * 32 bit processor * Complete with Fortran, Iso-Pascal, Cambridge Lisp, Panos, C, BBC Basic & 32016 Assembler * 1 megabyte RAM 	
ANC01 6502 2nd PROCESSOR	£159.00
<ul style="list-style-type: none"> * Complete with 64K Hi-Basic * Compatible with B, B+ and Master 	
ANC04 Z80 2nd PROCESSOR	£329.00
<ul style="list-style-type: none"> * 64K CPM * Complete with vast range of business software 	

ECONET

AMB12 BBC MASTER ET 128K	£320.00
<ul style="list-style-type: none"> * No DFS * Econet station * 128K memory 	
ADF10 ECONET MODULE FOR MASTER 128	£49.00
<ul style="list-style-type: none"> * Upgrades Master 128 for networking * Easy to install plug-in module 	
PTC11 ECONET KIT	£55.00
<ul style="list-style-type: none"> * Upgrades BBC B or BBC B+ (please specify when ordering) * Must be professionally fitted 	
AEH18 10 STATION LEAD SET	£25.00
AEH19 ECONET STARTER KIT	£79.00
AEH21 ECONET SOCKET KIT	£29.00
AES22 PRINT SERVER EPROM	£40.00
<ul style="list-style-type: none"> * Allows a BBC to be a printer server when Econetted 	
AND61 10 MEG WINCHESTER WITH FILE SERVER	£999.00
<ul style="list-style-type: none"> * Plus into 1 meg bus * Complete with ADFS and file server manuals * Built in fan and power supply 	

DRIVES

PTC01 DUAL 40/80TK DRIVES (MITSUBISHI)	£199.00
PTC02 DUAL 40/80TK DRIVES inc PSU (MITSUBISHI)	£210.00
PTC03 SINGLE DISC DRIVE (MITSUBISHI)	£109.00
PTC04 DUAL DISC DRIVES (MITSUBISHI)	£249.00
<ul style="list-style-type: none"> * In monitor bridge (Master size) * Built in fan and power supply 	
PCT10 400K DISC DRIVE AND 20 MEGABYTE WINCHESTER	£799.00
<ul style="list-style-type: none"> * In monitor bridge (Master size) * Built in fan and power supply * Other size Winchester available 	
CSX40S SINGLE 40/80TK DISC DRIVE (CUMANA)	£134.00
CSX80S DUAL 40/80TK DRIVES (CUMANA)	£260.00
CS800S DUAL 40/80TK DISC DRIVE inc PSU (CUMANA)	£295.00

PRINTERS

EPSON RX100+	£179.00
<ul style="list-style-type: none"> * 100 CPS wide carrier printer * IBM compatible * Extremely robust * Complete with tractor feed 	
EPSON LX80	£225.00
<ul style="list-style-type: none"> * 100 CPS * NLQ mode * Centronics interface 	
EPSON LX80 TRACTOR FEED	£18.00
EPSON LX80 SHEET FEEDER	£49.00
EPSON FX85	£399.00
<ul style="list-style-type: none"> * 160 CPS * Downloadable character set * Centronics interface 	
EPSON FX105	£499.00
<ul style="list-style-type: none"> * As above with wide carriage 	
EPSON FX85 TRACTOR FEED	£37.00
EPSON LQ800	£595.00
<ul style="list-style-type: none"> * 24 pin head * 180 CPS * Excellent near letter quality 	
EPSON LQ1000	£795.00
<ul style="list-style-type: none"> * Wide carriage version of above 	
KAGA TAXAN KP810	£229.00
<ul style="list-style-type: none"> * Low cost NLQ printer * Built in tractor feed * 160 CPS 	
KAGA TAXAN KP910	£389.00
<ul style="list-style-type: none"> * Wide carriage version of above 	
BROTHER HR15	£299.00
<ul style="list-style-type: none"> * Daisy wheel printer * Optional keyboard available * 15 CPS 	
QUEN DATA DWP1120	£169.00
<ul style="list-style-type: none"> * Daisy wheel printer * Robust construction * 20 CPS * Qume compatible 	
BROTHER M1509	£399.00
<ul style="list-style-type: none"> * 180 CPS * Built in tractor feed * RS232 and Centronics interface * IBM compatible * Full international character set * Epson compatible 	

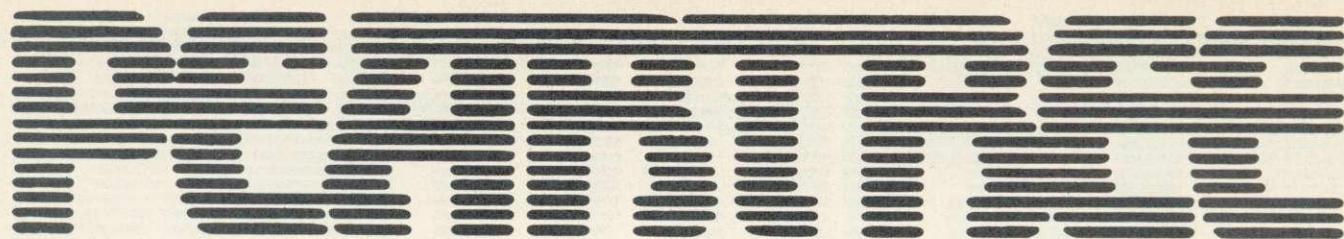

APPROVED ACORN SERVICE CENTRE

MONITORS

COLOUR

HANTAREX COLOUR MONITOR £159.00

- * Medium resolution
- * RGB interface
- * Composite video and sound input
- * Anti-glare filter

MICROVITEC 1451 COLOUR £235.00

- * Medium res monitor
- * Metal or plastic case
- * RGB interface
- * Complete with cable for BBC

MICROVITEC 1451 A/P £275.00

- * As above with audio and composite video input

MICROVITEC 1441 COLOUR £450.00

- * High resolution monitor
- * 895 pixels
- * RGB interface

TAXAN SUPER VISION 3 £349.00

- * Compact 12" super high resolution RGB colour display
- * Text switch gives green display
- * Super high contrast tube
- * 640 x 252 line resolution
- * 0.37 dot pitch

MONOCHROME

HANTAREX BOXER £69.00

- * High res green monitor
- * As preferred by educational establishments

KX1201 KAGA GREEN (P31) £89.50

KX1202 KGA GREEN (P39) £95.50

KX12003 KAGA AMBER (PUL) £95.50

- * P31 standard persistence
- * P39 long persistence
- * PUL long persistence
- * Greater than 20MHz bandwidth
- * Flat 635R tube
- * 1000 line resolution at centre

SOFTWARE

With every 3 ROMs purchased we will supply a MR3000 ROM board at no extra cost

COMPUTER CONCEPTS

WORDWISE £32.00

- * Mode 7 editing
- * Preview in mode 0 (80 cols)
- * Can produce ASCII text for modems

WORDWISE PLUS £45.00

- * As above with multi document editing
- * Built in programming language for data handling

INTER-SHEET £45.00

- * 40 80 and 105 column mode
- * Multiple spreadsheets in memory
- * 64 by 255 sheet size
- * ROM link

INTER-CHART £30.00

- * Built in Epson screen dump
- * Supports pie, line and bar charts
- * Line and bar graphs can be displayed on the same axis
- * Automatic scaling
- * ROM link

INTER-WORD £45.00

- * 80 or 105 column word processor
- * Continuous documents limited to disc size
- * Editing operations similar to Wordwise
- * ROM link

INTER-BASE £55.00

- * Compatible with all filing systems
- * Contains powerful Basic-like programming language
- * Card index mode
- * Powerful customising mode
- * Max 250 fields per record
- * Max 32K per field
- * Variable field lengths and records
- * ROM link

ACCELERATOR £51.00

- * Basic compiler
- * Can produce ROM/RAM format code from Basic programs
- * Comprehensive manual

CARETAKER £26.00

TERMI 2 £28.00

- * VT52 terminal emulation
- * Complete with file transfer software
- * Easy to use menu options
- * Custom configurations can be stored on disc

COMMUNICATOR £55.00

- * As above with VT100 emulation

SPEECH ROM £25.00

- * Must be used with Acorn speech processor
- * Liven up your programs

ACORNSOFT

VIEW 3.0 £58.00

- * Industry standard word processor
- * Complete with printer configuring utility
- * Can be used in any mode
- * BBC B, BBC B+, 6502, Shadow RAM, DFS and ADFS compatible
- * Complete with comprehensive manual

VIEW SHEET £42.00

- * Compatible with complete View range
- * Can be used in any mode
- * Windows can be selected for printing

VIEW STORE £38.00

- * Complete with report generator
- * File size limited only by disc storage size
- * Data can be imported from other View products

VIEW SPELL £33.00

- * Spelling checker for View
- * Complete with 70000 word dictionary
- * Dictionary can be extended to include technical terms

VIEW PLOT £25.00

- * Enables you to draw line, bar or pie graphs
- * Compatible with Viewsheet

VIEWINDEX £15.00

- * For View
- * Automatically creates index
- * Notes page numbers
- * Sorts alphabetically

VIEW PRINTER DRIVER GENERATOR £9.00

- * Used to personalise View documents to include special printer features

GXR GRAPHICS £23.00

- * Extends plot ANV VDU commands to provide: circle plotting, ellipses, parallelograms, dotted and dot dash patterns, shading patterns, colour fill, shade fill and sprites
- * Built in sprite designer
- * Please specify BBC B or BBC B+

ISO PASCAL £52.00

- * Full implementation of the ISO standard
- * Can use BBC's sound and graphics
- * Compiles to a compact intermediate code
- * Complete with demonstration disc

LOGO £52.00

- * Good introduction to computing for children
- * Turtle graphics supported

TERMULATOR £27.00

- * Terminal emulator ANSI (VT100), VT52, Tektronix 4010, dumb terminal, hardcopy terminal and a special BBC terminal
- * Enables the host computer to be sent directly to the BBC's output driver

COMAL £39.00

- * Programming language standard in many European countries
- * Encourages structured programming

BASIC EDITOR £25.00

- * Powerful full screen editor
- * Many word processor functions included

MICRO PROLOG £60.00

- * Designed to emphasise human logic rather than machine procedure
- * Step closer to artificial intelligence
- * 6502 compatible

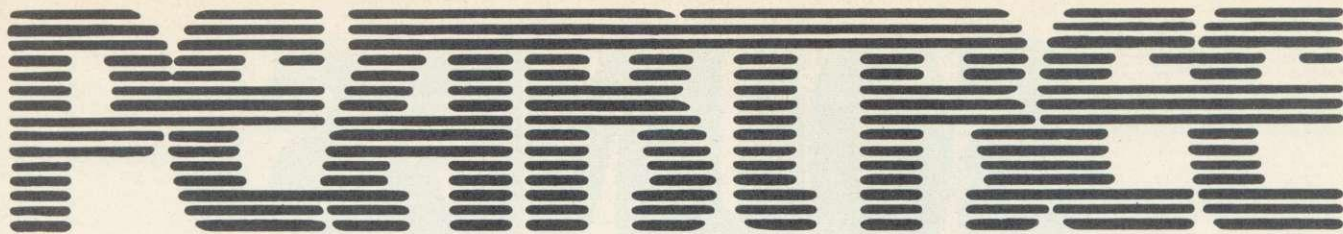

MASTERS IN STOCK NOW

SOFTWARE

BCPL	£50.00
BCPL CALCULATION	£35.00
BCPL STAND ALONE GENERATOR	£35.00
CREATIVE SOUND	£19.00

BEEBUGSOFT

TOOLKIT PLUS (ROM)	£35.00
SLEUTH (ROM)	£28.00
ROMIT (ROM)	£30.00
EXMON 2 (ROM)	£28.00
HELP 2 (ROM)	£27.00
SPELLCHECK 3 (ROM & DISC)	£32.00
DUMPMASER 2 (ROM)	£27.00
DUMPMASER (DISC)	£13.00
PROGRAM BUILDER (DISC)	£19.00
DISCMASER (DISC)	£19.00
TELETEXT (DISC)	£13.00
SPRITES (DISC)	£13.00
STUDIO EIGHT (DISC)	£19.00
ICON MASTER (ROM)	£30.00
WORDEASE (ROM)	£26.00
WORDEASE (DISC)	£19.00
MUROM (ROM)	£28.00
QUICKCALC (DISC)	£16.00
HERSHEY FONT (DISC)	£19.00
BILLBOARD (DIS)	£21.00
DESIGN (DISC)	£21.00
PAINTMASTER (DISC)	£15.00

LEADS

PTC50 BBC TO TV	£1.25
PTC51 BBC TO GREEN MONITOR	£2.95
PTC52 BBC TO SONY/KAGA COLOUR MONITOR	£5.95
PTC53 BBC TO MICROVITEC	£2.20
PTC54 PHONO TO PHONO	£1.25
PTC55 BNC TO BNC	£2.95

PTC56 BBC TO CASSETTE	£2.25
PTC57 BBC TO ACORN CASSETTE	£2.25
PTC58 BBC TO CENTRONICS PRINTER	£9.95
PTC59 BBC TO SERIAL PRINTER	£8.95
PTC60 4 WAY MAINS TRAILING SOCKET	£9.50

* Including two metre extension cable plus plug

MODEMS

PACE NIGHTINGALE	£109.00
* 1200/75 75/1200 300/300 baud rates	
* British Telecom approved	
* Complete with cable for BBC computer	
* Socket for through connection of telephone	
PACE NIGHTINGALE COMBO	£129.00
* As above with Commstar software	
PACE ACCESSORY BOARD	£42.00
* Autodialler	
* Auto baud rate selection via software	
* Autoanswer for your own bulletin boards	
* Built in loudspeaker for monitoring	
PACE AUTODIAL DISC	£9.00
* Sets up Commstar for autodial	
* Stores favourite numbers	
PACE OBBS COLOUR BULLETIN BOARD SOFTWARE	£20.00
* To be used with the accessory board	
* Create your own bulletin board	
* Create your own office answering service	
MINOR MIRACLES WS2000	£125.00
* Full range of baud rates	
* British Telecom approved	
* 25 way RS232 input	

CABLE FOR MODEM	£5.00
WS2000 AUTODIAL CARD	£30.00
CABLE FOR AUTODIAL	£4.00
SK1 KIT	£10.00
WS2000 AUTOANSWER KIT	£30.00

WS3000 V21/23 MODEM	£285.00
* Hayes compatible	
* Intelligent speed buffering	
* Line noise filtering	
* Internal battery backup allows 63 names and numbers to be stored	
* Printer port for direct connection to a printer	
* Includes cable	

DEMON MODEM	£76.00
-------------	--------

- * Auto dial, auto redial
- * Auto answer
- * Full and half duplex
- * CCIT and bell
- * Complete with mains supply, manual and ROM

DIAL DISC	£4.50
-----------	-------

SUPPLIES

RIBBONS FOR DOT MATRIX PRINTERS	£4.50
* FX/MX80/LX80 printer	
* Juki 5510 printer	
* MP165 printer	
RIBBON FOR KAGA KP810/CANON PW1080	£5.00
RIBBONS FOR 132 COL PRINTERS	£7.00
* FX100/RX100 printers	

BOOKS

THE EPSON PRINTER COMMANDS REVEALED	£5.95
* A must for all printer users	
* Commands for all Epson compatible printers	
* Easy to understand commands	
* Detailed explanations	
MASTER REFERENCE PART ONE	£14.95
MASTER REFERENCE PART TWO	£14.95
VIEW MANUAL	£10.00
VIEWSHEET MANUAL	£10.00
DFS OPERATING SYSTEM MANUAL	£6.95
ADVANCED USER GUIDE FOR BBC	£14.95

MAIN EDUCATIONAL SUPPLIER
We accept Government and Educational orders. If there are any products not listed above that you require, please enquire.

SOUNDS SPECTACULAR



Take it home — Plug it in to your computer and hi-fi system and start to make spectacular sounds using up to 16 sounds at once selected from the many preset instruments, waveforms and envelopes provided.

The new AMPLE Romeasy to use, powerful and versatile menu driven music

language. Includes 'Island Logic' music system style of Staff Editor. The Music 5000 synthesiser is now compatible with BBC B, BBC B+ and Master 128 (Music 500 is not compatible with BBC B+ and Master 128)

Dealer enquiries welcomed. We accept Education and Government orders

PEAR TREE

PEAR TREE

The black and white case for colour

Pear Tree are now offering the most powerful art package yet devised for the BBC Micro – Artist.

Artist is a new 16k language ROM compatible with the BBC Micro, BBC + and the new Master Series, allowing full manipulation of a mode-2 screen. With Artist and Megamouse, colour graphics take on a completely new dimension, which has to be seen to be believed.

Copying specific screen areas to exclude certain colours. Drawing and painting underneath any colour combination. Making your brush cycle through a defined colour sequence. Colour pattern editing. Sprites of any size. Animation. Just a hint of how Artist is the most highly advanced software package yet designed, with features never before seen on the BBC Micro. The only limitation of Artist is your imagination.

With the ultimate in art packages comes the ultimate mouse – Megamouse. Built to professional standards and comfortably shaped, it provides sensitive, accurate movement, that is unbeatable.

This exclusive Pear Tree offer includes the Artist ROM, the systems disc, a users manual and an excellent grey shade Epson printer dump.

You have the option of buying the Megamouse separately, or saving £10 by buying the complete package.

Artist is already ahead of its time. Don't be left behind – order now before it's too late.

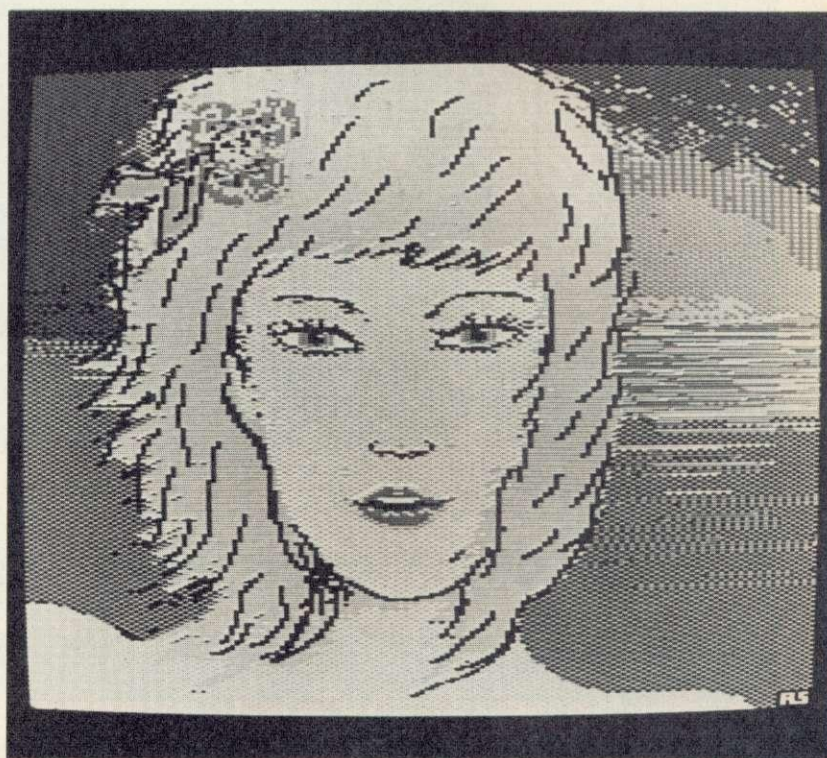

The Artist is compatible with the AMX Mouse and the Megamouse is compatible with the AMX Software.

Artist Software	£45.00
Megamouse	£49.00
Artist and Megamouse	£85.00



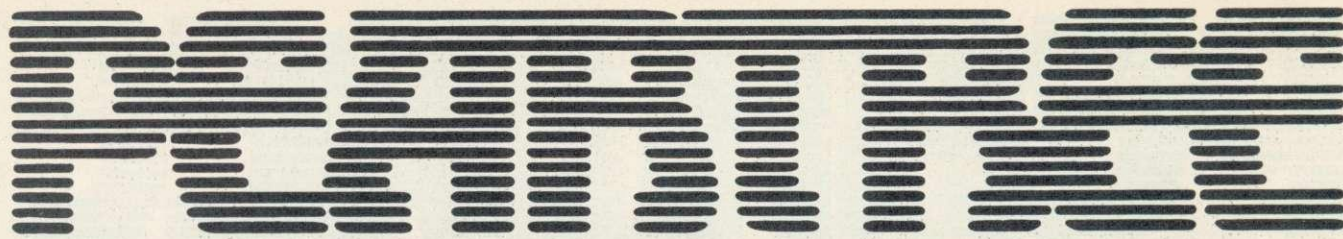

BBC IN SERIOUS CLOTHING

NEW LOW PRICE NOW ONLY £173.00 + VAT



KBL 128 PC £599.00

- * BBC B+ board with 128K
- * 86 key IBM style keyboard
- * Dual 40/80 track disc drives
- * All sockets at rear for easy access
- * Infra red keyboard option supplied as standard
- * Easy access to BBC B+ board for changing ROMS etc

**KBL 0 PC
KEYBOARD, CASE,
CABLES, FAN £173.00**

- PLUS OPTIONS**
- INFRA RED REMOTE CONTROL £24.00
 - BBC B BOARD £299.00
 - BBC B+ BOARD 64K £325.00
 - BBC B+ BOARD 128K £385.00
 - DUAL DISC DRIVES 80 TRACK £199.00
 - 6502 2ND PROCESSOR £159.00
 - Z80 2ND PROCESSOR £329.00
 - TORCH Z80 2ND PROCESSOR £199.00
- FITTING**
- DRIVES SINGLE £5.00
 - DUAL £9.50
 - COMPUTER £17.00
 - CARRIAGE £12.00

MEGAMOUSE

- * Fully AMX compatible
- * Because of all of this it is a popular AMX replacement



MEGAMOUSE £55.00

- * High quality UK manufactured
- * Highly accurate
- * Slip free rubber coated ball

- MEGAMOUSE AND SUPERART £95.00
- MEGAMOUSE AND PAGE MAKER £95.00
- AMX MOUSE WITH NEW SUPERART ROM AND DISC £65.00
- AMX DESK £19.00
- AMX UTILITY £11.50
- AMX SUPERART £43.00
- AMX PAGE MAKER £43.00
- AMX 3D ZICON £21.00
- AMX DATABASE £21.00
- AMX XAM £21.00

WATFORD ELECTRONICS BEEB VIDEO DIGITISER £99.00

- * Input from any 1V video source
- * Can be used with Artist package
- * 1.6 seconds scan time
- * Slow scan television; sending images via a modem or radio
- * Security
- * Full resolution in modes 0, 1 and 2
- * Up to 8 grey levels
- * Manual or auto level control
- * Connects to user port
- * ROM software supplied

MAGAZINE MAKER £125.00

- * Watford video digitiser and AMX Pagemaker
- * Pictures produced by digitiser can be doctored to make up pages complete with text
- * Complete package at a bargain price

PEAR TREE

Means Business

Pear Tree Computers Ltd. 12:00 01-10-85

PEAR TREE SOFTWARE
MAIN SYSTEM MENU

- 1 Stock Control
- 2 Customer Data Base
- 3 Purchase Ledger
- 4 Sales Ledger
- 5 Nominal Ledger
- 6 Invoicing and Credit Notes
- 7 Proforma Quotation
- 8 Petty Cash Control
- 9 Bank A/C Control
- C Create Data Disks
- E Exit from Main System

PLEASE CHOOSE ANY SYSTEM TO RUN

PROFIT
A complete business system for only
£69

The first complete, integrated business package for the BBC Micro

Running a business isn't easy, but Pear Tree can help make it simpler with the most cost effective business software package on the market today – Profit.

Profit is compatible with all disk filing and advance disk filing systems for the BBC B, BBC B+ and MASTER 128.

Developed for Pear Tree's own compatible KBL 128 PC, Profit is as easy to use as ABC. Everything you require in running a business is there – accounts, stock control, customer data base and even the immediate status of your bank account.

With Profit, all the time consuming problems, the reams of paperwork and valuable hours taken in administration can all be condensed down far more efficiently. The

net result is that you have far more time to concentrate on making your company grow.

Profit is simply a way to help you control your business more profitably. Complete the coupon today and start to profit from the software designed for your business.

PEAR TREE PROFIT

'Profit' is now held in high esteem in both the business and computer worlds: "This represents good quality Business Software compared to others on the market and I can recommend it."

(ACORN USER magazine review, April 1986)

PEAR TREE



Special Offers from PEARTREE[®]

<p>PEAR 1</p> <p>MASTER 128K EPSON RX100+ + SECURICOR DELIVERY</p> <p>Saving £148.00 of recommended retail price</p> <p>PEARTREE COMPUTERS</p>	<p>PEAR 2</p> <p>MASTER 128K EPSON PRINTER RX100+ AKHTER D/DRIVES AS ABOVE + SECURICOR DELIVERY</p> <p>Saving £192.00 of recommended retail price</p> <p>PEARTREE COMPUTERS</p>
<p>PEAR 3</p> <p>MASTER 128 EPSON PRINTER RX100+ AKHTER D/DRIVES AS ABOVE GREEN HI RES MONITOR + SECURICOR DELIVERY</p> <p>Saving £163.00 of recommended retail price</p> <p>PEARTREE COMPUTERS</p>	<p>PEAR 4</p> <p>MASTER 128K EPSON PRINTER RX100+ AKHTER D/DRIVES AS ABOVE MITSUBISHI MED RES COL MONITOR</p> <p>Saving £168.00 of recommended retail price</p> <p>PEARTREE COMPUTERS</p>



THE FANTASTIC EPSON RX100+ NOW ONLY **£179.00**

- * 100 C.P.S.
- * Built-in tractor feed
- * 2K buffer
- * Wide carriage
- * Epson reliability
- * International character sets

PEAR1

The All in One System £799.00

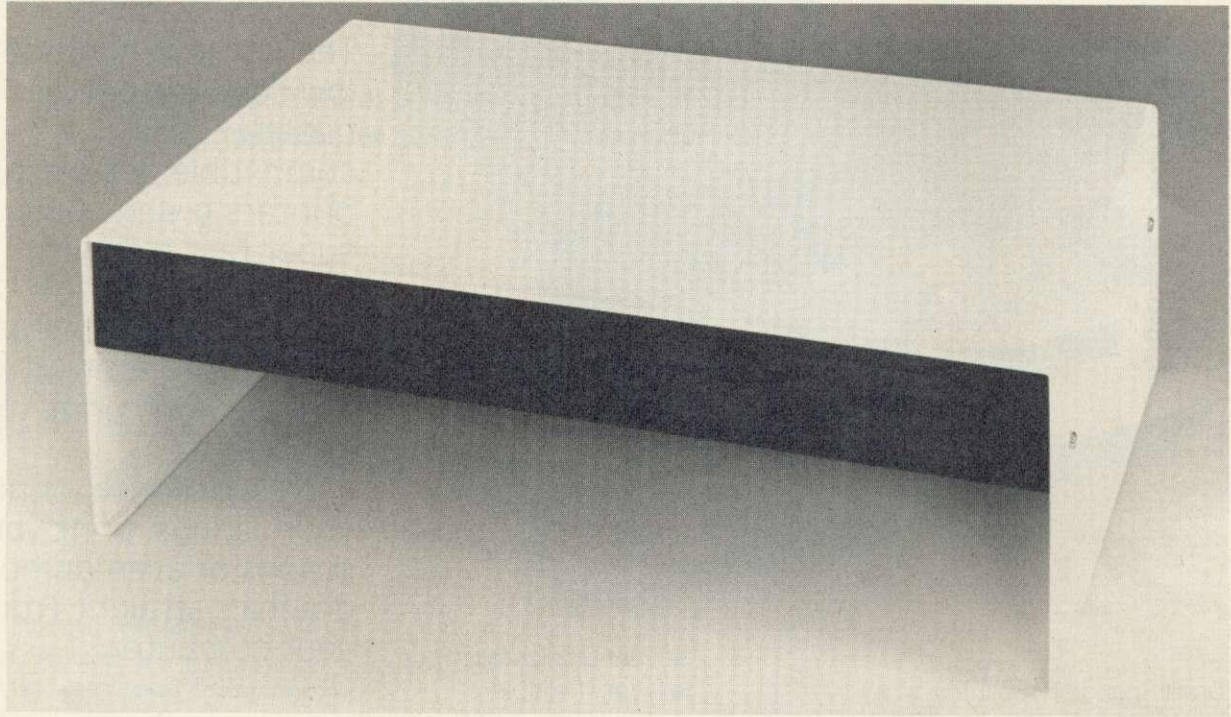

20 Megabyte Acorn Compatible Hard Disc with 5 1/4" DISC DRIVE BUILT IN

- ★ In Master Bridge
- ★ Built in Fan
- ★ Through Power Connector for Monitor
- ★ Can be supplied with Level 3 File Server

The above system is compatible with BBC B, BBC B+ and Master. For machines other than the Master please order an ADFS Rom.

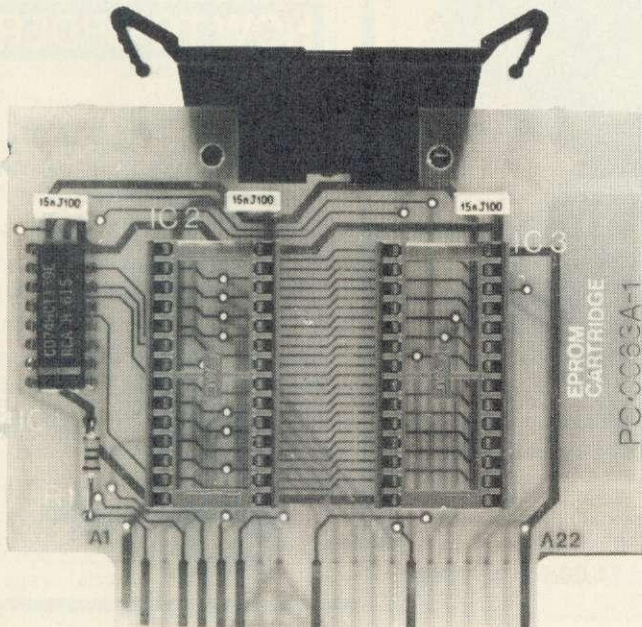

IN STOCK NOW
Pear1 Master
Cartridge
only £5.95

PEAR TREE

MP165 at a new low price of £199

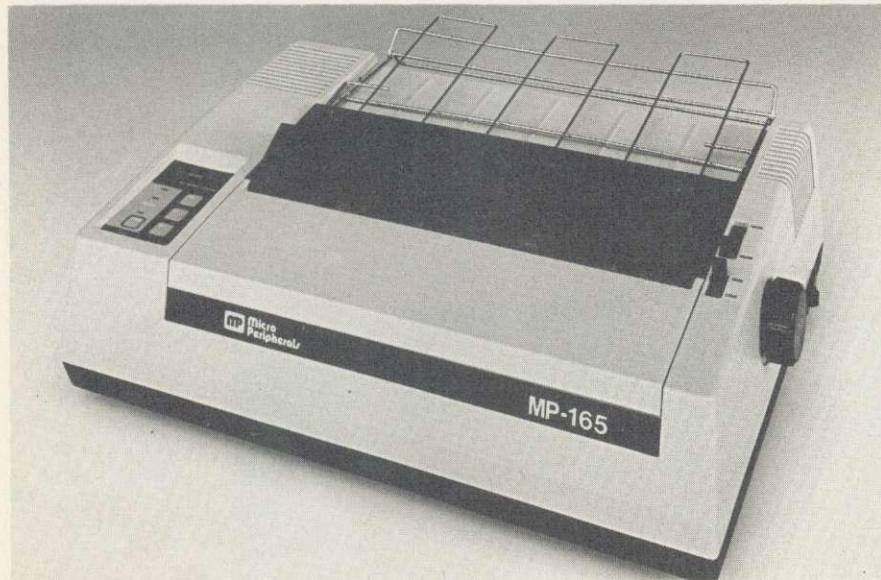

The latest generation of low cost near letter quality Epson compatible dot matrix printers giving you a super fast standard quality print at 165 CPS and a superb 40 CPS in NLQ. This printer will do all your work, print your important correspondence, print your listings, print your graphs or even dump graphics straight from your computer.

Features

- ★ Draft Speed of 165 C.P.S.
- ★ Near Letter Quality Speed of 38 C.P.S.
- ★ 2K Buffer
- ★ Maximum of 95 Downloadable Characters
- ★ Centronics Interface
- ★ Very Reliable
- ★ Excellent Graphics Quality
- ★ Built In Tractor Feed
- ★ Fully Epson Compatible

NEW Improved MR3000 & MR4200

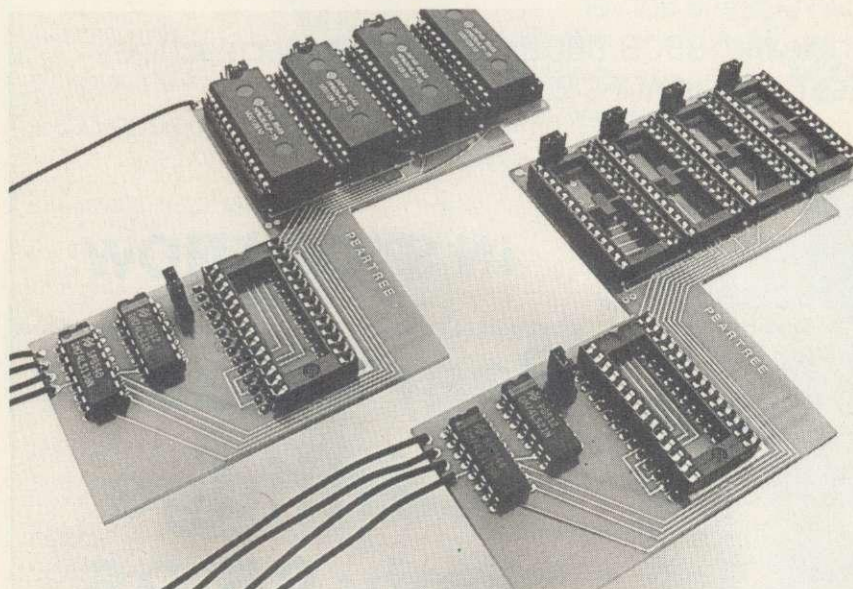

MR3000 Mini-Rom Board:

Gives 4 extra Rom sockets on BBC 'B'. Only £9.95. Full instructions enclosed.

MR4200 Mini 32K Ram Board:

Inclusive of the Hitachi 6264LP-15 Ram. Full Software inclusive. Add £1.00 for no solder version of either board. Only £24.00

PEAR TREE COMPUTERS

HOW TO ORDER

Bulk order discounts are available on some items. Government and Educational orders are welcome. Orders will whenever possible, be despatched on the same day.

All prices quoted exclude VAT and P & P. Postage will be charged as follows:

Items below £10.00	add £1.50
Items below £50.00	add £2.50
Items below £100.00	add £3.50
Items over £100.00	add £8.00

We accept



ON THE MENU

A visible menu is one of the most popular ways of communicating with an operational program. Joe shows how to devise menus to fit most situations

Joe Telford

One of the problems we all come up against is that of communicating with an operational program. Many of the Teach-yourself-Basic-type books begin with an apparently simple little program such as:

```
INPUT x
LET a=x*2
PRINT a
```

and spend little time considering the necessary explanations for input or output. In fact it is important that we understand what the computer program requires of us, and what information it is presenting. The menus given in this article should work on all versions of the BBC micro, Master 128, Electron and 6502 second processors.

I once started a talk about the Human Machine Interface (HMI) with the statement: 'There are three major ways in which we can control the execution of a program!' A voice from the back called out 'Don't you mean four?' Not wishing to demean myself I continued, 'There are three major techniques, beginning with the menu-driven approach.' There was a slight pause, and the voice from the back of the hall called out, 'Five!'

The moral of the story is that we should always get our frame of reference agreed by everyone as quickly as possible. So let's start by considering just how we can control the execution of a program. This is quite an easy task. Examining a range of software should lead us to some generalisations.

Elite is controlled by joysticks, paddles, mice and tracker balls, so we need to include control by external devices as one item on our list. *Wordwise* is a classic example of a single keypress control system working from a menu. *The Hobbit* adventure has an almost free-form sentence entry format. *AU's Super Painter* program employs a single key control system operating from the function key overlay. *The*

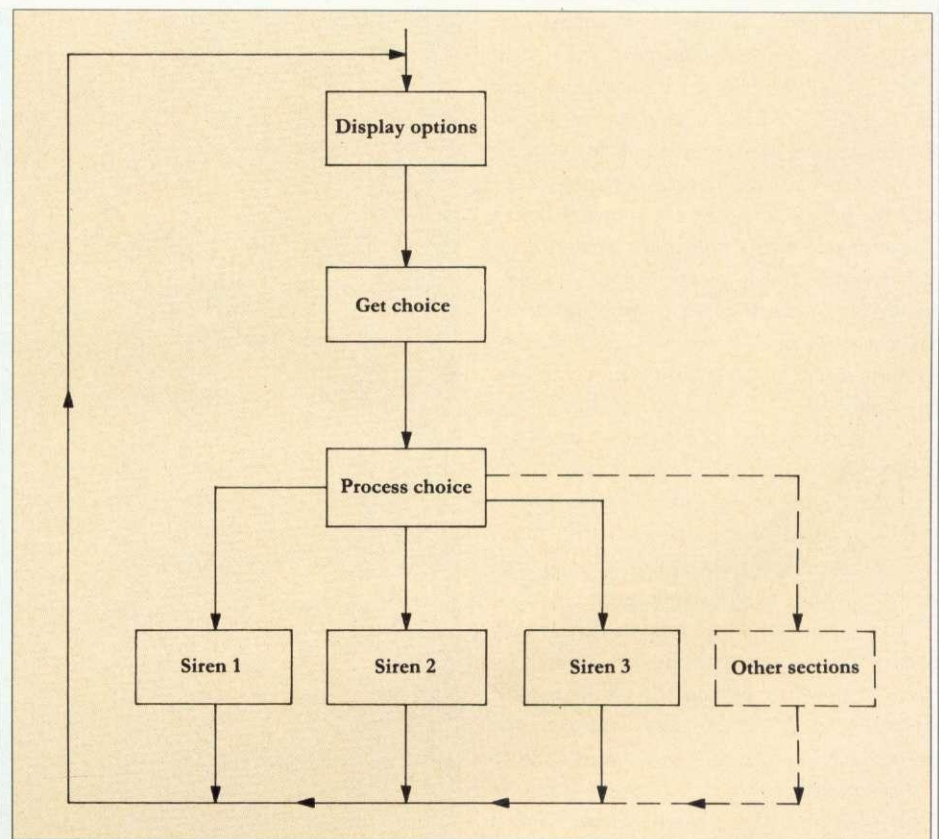

Figure 1. The structure of a typical menu. The main menu is enclosed in a loop

Basic Editor uses a combination of single word commands and single function key presses.

OK, so what does this boil down to? Well it does actually (and conveniently for me) reduce to three main types of control systems:

1. The visible menu and associated single word entry
2. Invisible menus and associated single key presses (including joysticks, etc)
3. The free format command sentence which is then decoded and acted on.

The only one of these which needs immediate amplification is the invisible menu of item 2. An invisible menu includes those commands which are shown on a function key overlay

strip or the regularly-used keys for, say, *Snap-per*. Have you ever thought how you would play *Killer Gorilla* successfully with a screen that continually showed:

```
Press z for left
      x for right
      / for down
      : for up
      Return to jump
```

In this article I show how to create visible menus, which direct the user to enter particular keypresses, how the computer can process that input, and how to protect against some of the problems that arise.

Adapting one of the menus given will fill

JOE'S JOTTINGS

most situations. In future articles I'll cover other types of program control.

A visible menu has three parts: the action of displaying information; the process of accepting the users entry; and the action of selecting an appropriate part of the program as a result of that entry.

Strictly speaking a menu is mainly concerned with the first of these two points, but the approach to the third part often has to be modified depending on the specific menu. Figure 1 is a diagram of a typical menu and its component parts. Notice that it is usual for the main menu in a program to be enclosed in a loop so that choices can be made a number of times. Visible menus are most often used in programs where the maximum number of choices are limited and the program writer can handle all possible outcomes. Of course such menus leave themselves open to 'If only he'd added facility xxx', but generally they provide the simplest and most effective means of communication between user and program.

Many menus use single key presses to indicate the user's choice. My approach with a visual menu which requires alphanumeric input is that we should always: put up some sort of prompt; allow the user to type and delete characters; expect the user to press Return to confirm that choice; and decode the choice and act on it.

Some menus (as we will see later) are graphic and rely on specific keypresses. In this case the approach is to: allow the user to press any keys; change the item on the menu whenever a selector key is pressed; and confirm that choice by pressing Return.

Looking at figure 1 we need to identify each area of the program and produce a matching piece of code. In each of the following programs we will use the same four common procedures, representing four major sections of a menu-driven program shown in listing 10. They include PROCs Siren1, Siren2, Siren3 and Phone: we are writing a sound effects menu-driven program.

These four procedures are relatively easy to understand. Sirens 1 and 3 are driven by varying the frequency parameters of envelope 1, while the twin-tone siren 2 is two distinct sound commands. The complex sound pattern of a trimphone is achieved by using four sound commands to sequence the warble created by a new envelope 1. Remember to add these procedures onto the end of each of the menus that you type in. The best way to do this is to enter the procedures and SPOOL them to tape or disc by typing:

```
*SPOOL proc  
LIST  
*SPOOL
```

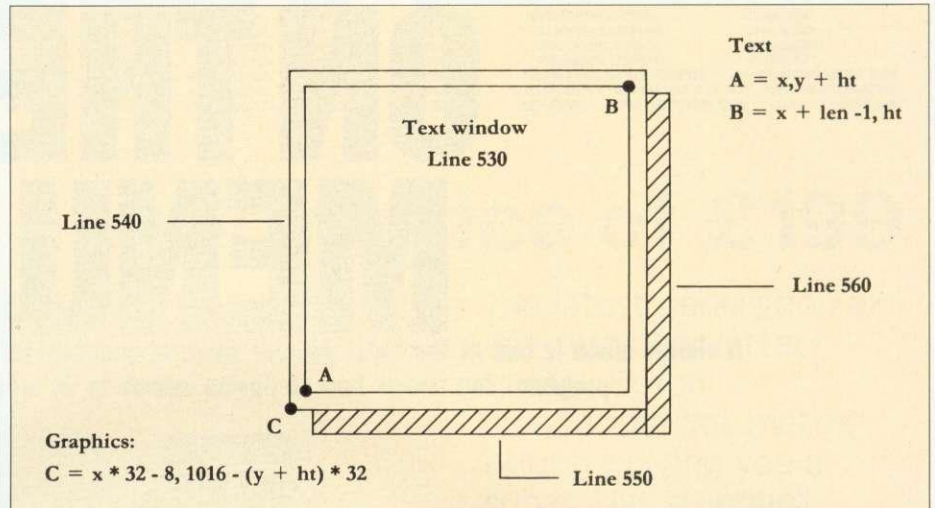
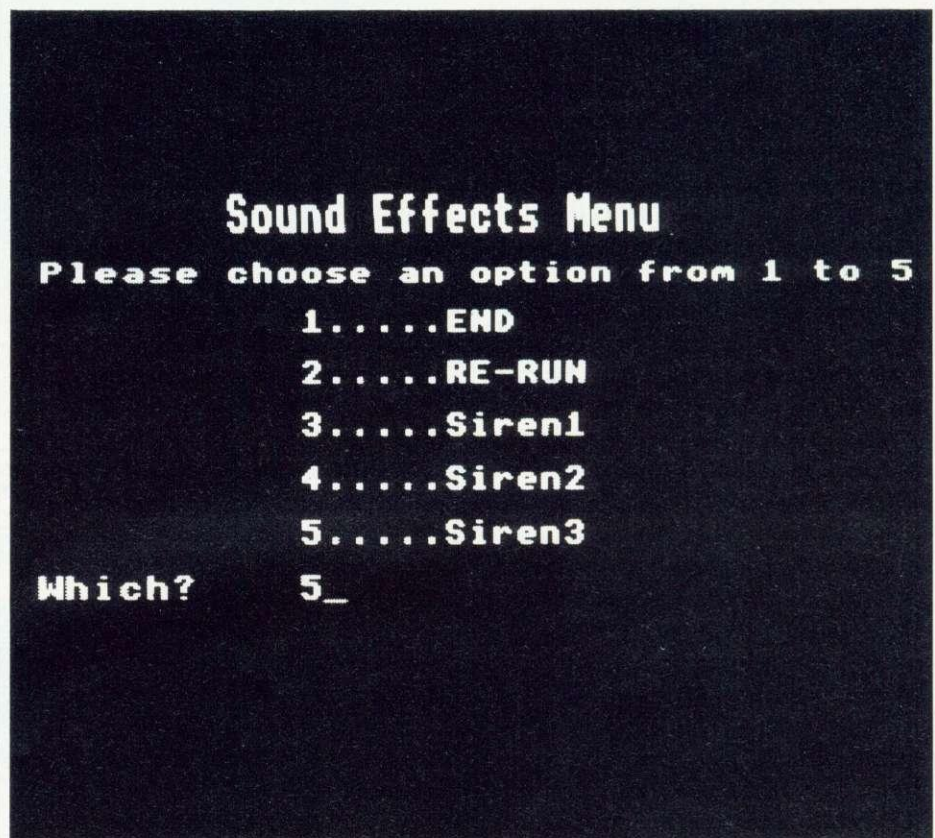

Figure 2. The maths behind the window menu program given in listing 9 on the yellow pages



The simplest type of menu – make your choice by hitting the key for the relevant number

They can be added to the end of another program later by typing:

```
*EXEC proc
```

Although there are four procedures, our menus are all set up for three procedures. If you wish to add the phone sound then you will have to alter the menus given. The idea of this is to give you some gentle homework. However, we will give advice on how to do this as we go along.

Building a simple menu

Let's use figure 1 to write the simplest of all menu programs, which will include a few warts. Notice that the whole program is

enclosed within a loop, so we can start off by initiating this loop:

```
80 REPEAT
```

Now figure 1 tells us to display the options available to the user, and we can do this using three lines:

```
90 PRINT"1...Siren 1"  
100 PRINT"2...Siren 2"  
110 PRINT"3...Siren 3"
```

Gosh, this is easy! The next box in the structures says get the user's choice, and we accomplish this with a single line which demands an input:

```
120 INPUT"Which?"choice
```

Finally we are expected to decode and process

the number typed. This will take one line of program per option:

```
130 IF choice=1 PROCsiren1
140 IF choice=2 PROCsiren2
150 IF choice=3 PROCsiren3
```

Then, finally, we must indicate the end of the loop, and this is done with:

```
160 UNTIL FALSE
```

which indicates that the whole thing happens continually. Now just add your four extra procedures and type RUN. Pressing 1 followed by Return should give you Siren 1, pressing 2 and Return will give Siren 2 and pressing 3 and Return will give Siren 3. The complete program is shown again in a tidier form as listing 1 on the yellow pages.

Let's think for a moment. What is tacky about this program? Ask yourself:

- How can we stop the program?
- How can we restart the program? (In a business program, a re-start might be the fastest way to reset the program for another try)
- What happens when we press 0 or -1 or 6 or type garbage?

However, just before we discard menu 1 entirely, remember it might just be something which you would want to use to drive your own programs quickly as an aid to debugging. Let's add a couple of things to improve it.

Listing 2 shows the simple menu upgraded to handle the first two items in our list, and it now makes an attempt at checking the range of the number entered. Notice that each line of the display section (100 to 140) has a corresponding line in the decoding section (lines 170 to 210).

We can now think about adding the Phone option as option 6. But now that we have a range check in the loop from line 90 to 160, we will need to increase the range of choices to greater than 0 and less than 7.

The benefit of putting the menu into a procedure is that the main body of the program becomes shorter and easier to handle. A particular quirk of my mentality is that I only include the display and user input in my procedures. I leave the processing in the main body of the program because I often want to do mode changes and other things which are illegal inside procedures. Look at listing 3 and you will see that it is identical to listing 2, except that the display/input section of listing 2 (lines 90 to 160) is replaced by line 90... PROCmenu.

Looking further down the listing we come to DEFPROCmenu at line 170. This contains the code, from listing 2, line for line. The main benefit is one of readability.

The main body of the program is shorter and more easily understandable. The

DEFPROCmenu section can be slotted anywhere after the end of the main body.

Yet the search for a satisfactory menu cannot stop with procedures. The variable called 'choice' must now be global, ie, it has to exist in the procedure and in the main body of the program, and it should contain identical information in both areas. In a large program containing several menus, this might not be appropriate, and the variable could change value if it is used in two or more different procedures.

What we really need is a means of keeping variables in procedures local to those procedures, but to return a value from the procedure to the main program. This can be done by using functions.

Most of the menus which I use are actually

which can be input whenever an 'out of range' number is typed.

It might be worth coming back to our homework problem of extending an existing menu. To add a 'phone' to menu 4 we must consider the following points:

- Add a process line for option 6 at line 145
- Add a display line for option 6 at line 235
- Alter line 260 to cope with "choice > 6".....
- Alter line 270 to cope with "choice < 7"

Better layout

The choice of layout is not critical if you are dabbling for your own benefit. However, as soon as you extend a program's use to others, then layout and screen design become important. If the program is intended for wide distribution and for money-making purposes,

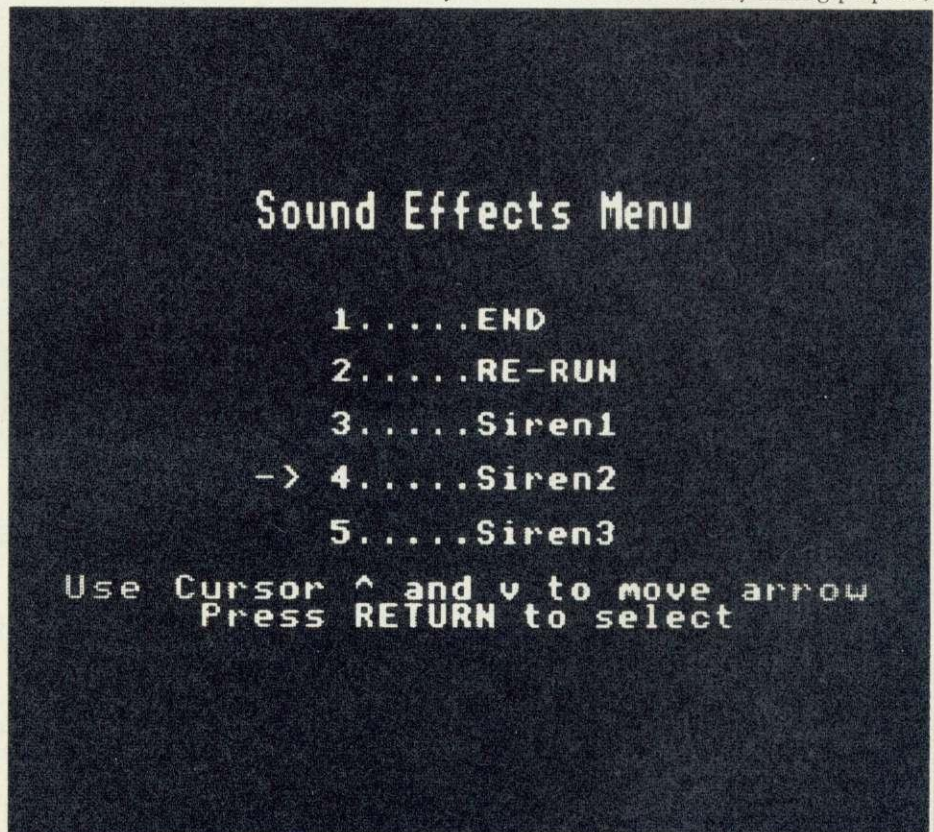

On this sophisticated menu, the user moves the on-screen arrow with the cursor keys to make a selection

function menus in one form or another. Look at listing 4, for example. The points of interest start with line 90:

```
90 choice = FNmenu
```

This indicates that the menu function is returning a value to 'choice' and that choice is only found in the main body of the program. This will make debugging easier. Matching this change is the DEFFNmenu of line 170 and the = choice of line 280. Notice that although the word 'choice' is used in DEFFNmenu it is declared LOCAL by line 180. This means that it is quite separate from the variable 'choice' in the main program. In addition we've added a line 260 which points out the range of numbers

then screen layout will sell more programs than your nifty little matrix manipulation routine, buried in your software.

Listing 5 shows how the screen layout can be improved considerably, but the cost is program size, which always increases as the layout improves. My own approach is to make use of mode 7 for most menus. This is advantageous because controlling teletext graphics uses less program space than the equivalent layout commands for the other modes. Conscious of readers with Electrons, I'll stay in mode 4 and accept the increase in memory usage which this entails. The screen layout is all performed in DEFFNmenu from

IT MAY LOOK LIKE A SINGLE DISC DRIVE TO YOU...



BUT YOUR COMPUTER KNOWS BETTER

£199.95
(256K RAM)
£249.95
(512K RAM)



It's the clever bits only your BBC computer can see which help the Opus Challenger outperform every other disc drive on the market, including dual drive systems.

Only Challenger has both a conventional double-sided floppy disc drive and a high technology RAM disc, effectively a second, lightning fast solid state disc drive which turns your unit into a unique dual system with up to a massive 1.2 Megabytes of useable capacity.

Only Challenger has its own built-in double density disc interface, making all that soldering and track cutting associated with other interface connections, a thing of the past. Just plug-in and away you go.

You'll find more performance than from any dual disc drive system and from only £199.95, Challenger is up to £50 cheaper than even the most inexpensive twin drive and interface package. Unbeatable value and a unique 3-in-1 combination:

- 5 1/4" DOUBLE-SIDED 40/80 TRACK DISC DRIVE
- BUILT-IN DOUBLE DENSITY DISC INTERFACE
- INTEGRAL SOLID STATE RAM DISC Up to 20 times faster than a disc drive and now available in 256K and 512K versions*

With all that power and performance you can race through work conventional disc drives labour over and, when you need to save to floppy, the RAM disc backs-up your information in a fraction of the time without any need for tiresome disc swapping. A & B Computing, which voted Challenger "Best buy of the year", said: "Using the RAM disc is a real dream... We checked a document just over 21K long, which took 5 minutes 56 seconds on floppy and only 1 minute 7 seconds using the RAM disc".

You don't even need to worry about compatibility. We've fitted the same disc controller chip used on the BBC B+ to make Challenger compatible with all leading software titles and it's suitable for use with the new 128 Master Series.

Challenger's price even includes VAT, FREE 72-hour delivery, the unbeatable Opus two-year warranty and a full operating manual.

So call us now on 0737 65080 for details of our nationwide dealer network or simply post the coupon. Generous education and dealer discounts available.

CHALLENGER – SIMPLY LIGHT YEARS AHEAD OF THE OPPOSITION

To: Opus Supplies Limited, 55 Ormside Way, Holmethorpe Industrial Estate, Redhill, Surrey.
Please rush me the following: (PRICES INCLUDE VAT AND CARRIAGE)

Challenger Unit(s) £199.95 each including 256K RAM disc

Challenger Unit(s) £249.95 each including 512K RAM disc

I enclose a cheque for £ _____ or please debit my credit card
account with the amount of £ _____

My Access Visa no. is:

NAME _____

ADDRESS _____

TELEPHONE _____ AC

line 170 onward. The title is always important and this often looks best if set in double height characters. A routine for handling this in mode 4 is given in DEFPROCdouble.

The double height procedure takes X and Y text co-ordinate positions, and a string of characters to print in double height. If the X parameter is greater than 80 then this signals the procedure to centralise the string across the screen at the Y co-ordinate given. Character doubling is performed by reading the definition of each character in turn using an OSWORD with A% set to 10. Character 128 is then redefined twice, to give the top half of the character and the bottom half. This redefining and printing happens in line 430. The c% variable points to some spare memory from location &71 to &78.

The next most useful improvement is to centralise the menu itself. This is done by using the PRINTTABs of lines 200 to 250. You must decide on the values chosen considering the number of menu lines, and their length. Notice also that the entry section of lines 260 to 300 is much altered. It uses PRINTTABs to define the position of all input on the screen. Notice too that the REPEAT loop of 260 to 300, combined with the INPUTTAB of line 280, means that there will be no movement of the menu on the screen. Line 270 prints a Which? message followed by a string of 20 spaces, which tidy the last input from the user.

General-purpose menu

Now it's time to think about a general-purpose menu routine. Menu 5 starts us on the way by transmitting two parameters in FNmenu(1,5) of line 90. These are decoded as the minimum and maximum acceptable values for the range check, and we can see their action in lines 290 and 300. However, we still have a long way to go to a totally transportable menu.

Using the input command to get the user's choice is fraught with danger. Certainly the program we have introduced in menu 4 is reasonably resistant to typing errors but try typing a long line (greater than the 20 blanking spaces) and see the result - untidy, to say the least. The usual alternatives to INPUT are either GET\$ or INKEY\$. To make either of these behave like an 'intelligent' INPUT routine would require a special routine which would allow typing and deletion of one or two characters, depending on the number of options available; selection of characters so that only numbers or letters would be accepted as appropriate; and comprehension that the Return key marks the end of INPUT.

Now we must make a difficult decision. Do we try to refine our existing menu to handle this intelligent INPUT, or do we go for an

alternative to numerical input? I'll follow the latter path.

The route which we now follow will lead us to a more user-friendly approach to indicating menu options. Look at listing 6. This is almost identical to listing 5 as far as line 260. After this line we enter a routine which tests for only three keypresses. The Cursor Up key, the Cursor Down key and the Return key. Instead of the 'ch' variable we use a 'menuptr' (menupointer) which indicates the number of the currently selected item. The routine between lines 310 and 370 increments or decrements the value of menuptr depending on which key is pressed. Once the Return key is pressed the current value of menuptr is returned to the main program. Line 320 prints an arrow which points at the current option (→).

cursor keys using the GET command. Lines 380 and 70 both restore the cursor keys to their normal function. Line 70 is a simple error trap, which in repetitive menus is best placed outside the main program loop, so that the effect of Escape is to restart the main loop. However, during debugging I suggest you miss it out until the program is functioning. To improve error trapping, it could be altered to:

```
70 ON ERROR IF ERR < > 17
REPORT:END ELSE *FX4,0
```

Notice too, the VDU23 commands of lines 110 and 190. These turn the cursor on and off respectively. If they misbehave on your machine just miss them out. Finally, in menu 6 don't forget to add DEFPROCdouble which I have left out for simplicity.

We're really doing well now, but think a

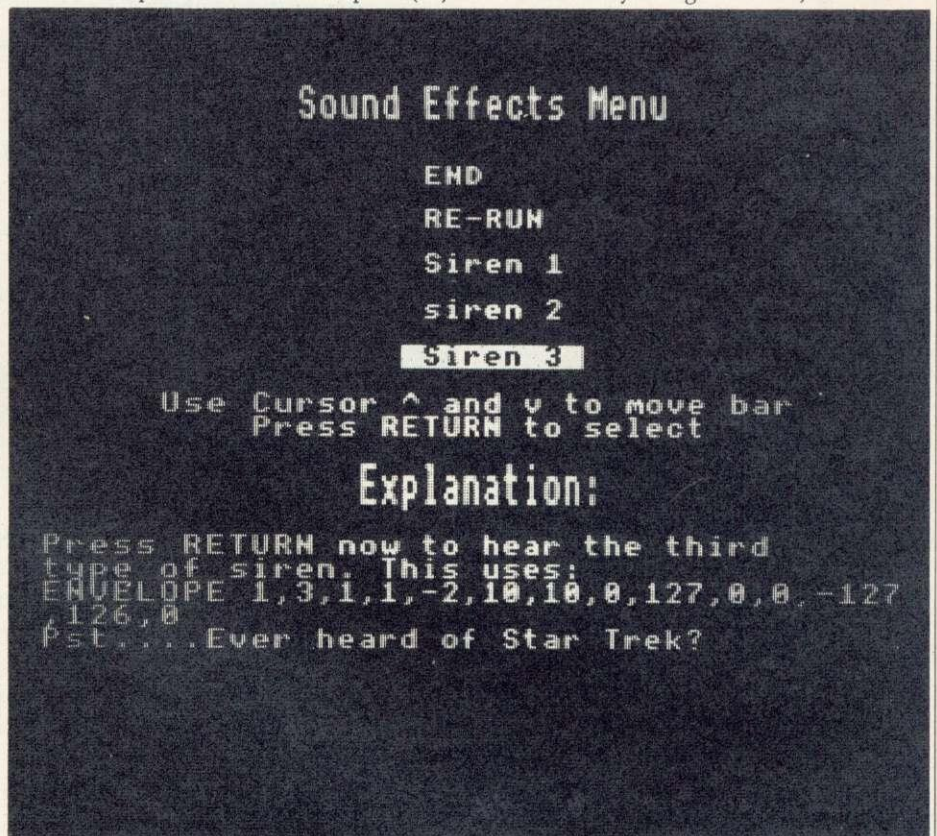

This menu incorporates an explanation of the option you have chosen by moving the bar

Line 330 waits for a keypress, and line 340 deletes the arrow indicator by overprinting it with a couple of spaces. Lines 350 and 360 alter menuptr depending on the keypress. Notice that the last IF statement in each of these lines causes the menuptr to 'wrap' from top to bottom and bottom to top. Users who dislike wrapping can rewrite the lines:

```
350 IF key = 139 menuptr = menuptr - 1:
IF menuptr = min - 1 menuptr = min
```

```
360 IF key = 138 menuptr = menuptr + 1:
IF menuptr = max + 1 menuptr = max
```

The following additions to menu 6 also apply to the remaining menu programs. The *FX4,1 of line 290 allows the micro to examine the

moment. How effective an indicator is that little "→" arrow? What we really need is some means of drawing attention to the options in a powerful way. One approach is to highlight the current option by displaying it in reversed colour, ie, black on a white bar. This requires further use of memory.

Look at listing 7. The major alteration here is the approach to the display section. First a list called menu\$() is dimensioned for five items (line 70). Next the five items are entered into the list (lines 200 and 240). Notice that they are padded with spaces to make them all the same length to improve presentation. Now the display section and the keypresses are

JOE'S JOTTINGS

included in the same loop from lines 300 to 410. The first three lines (310-330) inside this loop are dedicated to printing the menu options, using line 320 to check for the currently selected option, and to set the printing colours accordingly. The weird and wonderful PRINTTAB (16,3+loop%*2) of line 330 is set by the programmer to achieve the required layout of the options. Altering the 16 will alter the horizontal position of the menu on screen. Altering the 3 alters the vertical start position of the menu. Altering the 2 will increase or decrease the gap between options.

Explaining things

Often, particularly when writing a menu which chains programs from a disc, it can be useful if users are given more information than the program title. Such expanded explanations can be achieved by adding an extra procedure to menu 7. If we simply alter line 320 to read:

```
IF loop% = menuptr PROCexplain
(menuptr):COLOUR0:COLOUR129:
ELSE COLOUR1:COLOUR128
```

then we can call on PROCexplain to expand on each option, below the menu. Listing 8 shows how we can add such a DEFPROCexplain to Menu 7 to get menu 8. Notice how line 490 blanks a suitable area below the menu (240 spaces or six lines) ready for the explanation. To keep the explanations concise we use quite complex PRINT statements involving the " mark to give line feeds within the single print statement. The other additions to menu 8 are the VDU19 statements of lines 100 and 110. Some would say that these improve the screen colours. Remember that menu 8 also needs DEFPROCdouble.

Homework time again! Adding the phone option to this menu will require us to cope with the following points:

- Adding a line 185 to process the PROCphone
- Alter the dim to allow for menu\$(6)
- Alter the FNmenu of line 130 to go up to 6
- Add a line 265 to include menu\$(6) = "Phone"
- Add a line 555 to explain the phone (IF m = 6 PRINT . . .)

The final stage in our search for the perfect menu takes us closer to the general purpose menu. Of course the user needs to understand the general principles behind windows and 'pop-up' menus. As long as your user can handle the up and down cursor keys and press Return, he or she will be able to drive a menu window. Listing 9 is the window menu program which is configured to handle menus of up to ten displayed items. This is set by

the DIM m\$(10) at line 70. Notice that the list has been renamed m\$(0) rather than menu\$(0) to save space. The actual window menu is called by line 130:

```
Choice = FNwmenu("Sound Effects",5,
"END","RE-RUN","Siren 1",Siren 2",
"Siren 3","","","","")
```

Notice that we send 12 parameters to DEFFNwmenu. These include:

- Parameter 1: The title of the window
- Parameter 2: The number of menu options (say n)
- Parameter 3: The 1st menu option string
- Parameter 2 + n: The last option string
- Parameter 2 + n + 1: The first null string
- Parameter 12: The last null string

Always transmit as many parameters as

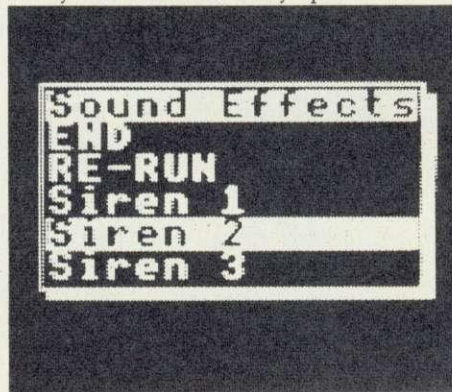

Dropped shadow box menu

the DEFFN expects to receive. Hence in our example we send the spare options as null strings.

Line 210 receives the 12 parameters and places all the strings into m\$(0) . . . m\$(10). The number of viable options is received in the variable 'max'. Before any menu display can take place the strings must be measured so that a window can be defined into which they will all fit. This is done in lines 220 to 250. By line 240 the variable 'len' contains the length of the largest string, including the title string. The next stage is to open a window, and this is done by line 280 which calls PROCopenwindow with four parameters. These comprise the text X,Y co-ordinates of the top left of the window, along with the width of the window (len) and the number of lines in the window (max + 1).

DEFPROCopenwindow defines the text window in line 550 and then proceeds to frame it with a graphics rectangle and shadow, which is reminiscent of GEM or Mac type windows. The maths of lines 560 to 580 will work in modes 4 and 1 and is shown in figure 2. These lines can be lost in modes 6 and 3. The 'x*32+8' values will need changing to 'x*16+4'

mode 0 and to 'x*64+32' for modes 2 and 5. DEFPROCrect is a straightforward rectangle drawing procedure. Its 'f' parameter is a 'fill' flag and if set to 1 the rectangle is filled, while set to 0, 'f' causes an outline to be drawn.

Once the window is opened, the next stage is to display the menu and this is done by lines 320 to 350. The title line and the current option are highlighted by line 330 but only the current option bar moves.

The choice loop repeats from line 300 to 400 and the window is reprinted on each keypress, with the option bar adjusted if necessary by lines 380 and 390. Note that we have lost our 'min' variable.

Once the Return key has been pressed menuptr is returned to the main program for further processing. Tidiness dictates that the window should be closed, and this is achieved via PROCclosewindow, which after clearing windows with a VDU26 in line 460 proceeds to call PROCopenwindow again, but with the GCOL set to erase the graphics frame. Lines 490, 500 and 510 then clear the window, delete windowing, and reset the normal GCOL0,1 option. Lines 140 to 180 are the standard processing section which we have maintained throughout. Remember that the four effects procedures need loading for this program, but DEFPROCdouble is no longer required.

Updating this program to add additional options is extremely easy, up to the present limit of 10 options. As an example, we can amend the program to handle the trimphone sound by adding:

```
130 choice = FNwmenu ("Sound Effects", 6, "END", "RE-RUN", "Siren 1", Siren 2", "Siren 3", "Trim Phone", "", "", "", "")
```

```
145 IF choice = 6 PROCphone
Notice that the changes to line 130 are the 5 into a 6 and the first null string into a "Trim Phone".
```

You may want to use one or other of these basic menus to index your discs. The most useful is probably menu 8, which would contain explanations of the various programs on offer. No real alteration to the menu program would be needed, except to include the correct program names with the correct options, eg:

```
160 IF choice = 3 CHAIN "PROG1"
The way forward probably lies with mouse-driven symbolic menus currently found on the Mac, Atari and the Master 512, and I may well look at them in a future issue.
```

See the index to the yellow pages on page 113 for details of where to find Joe's listings

Yes - it's bargain- hunting time again!

For BBC Micro and Electron users this is the start of the top buying period of the year - the time when they stock up with all the latest hardware and software that will enhance the versatility, power - and just sheer fun! - of their micros.

And the ideal time to hold the Electron & BBC Micro User Show, where they get the best of both worlds - a first look at all the fascinating new-season products, and a chance to pick up really worthwhile bargains as yesterday's top sellers are sold at rock-bottom prices!

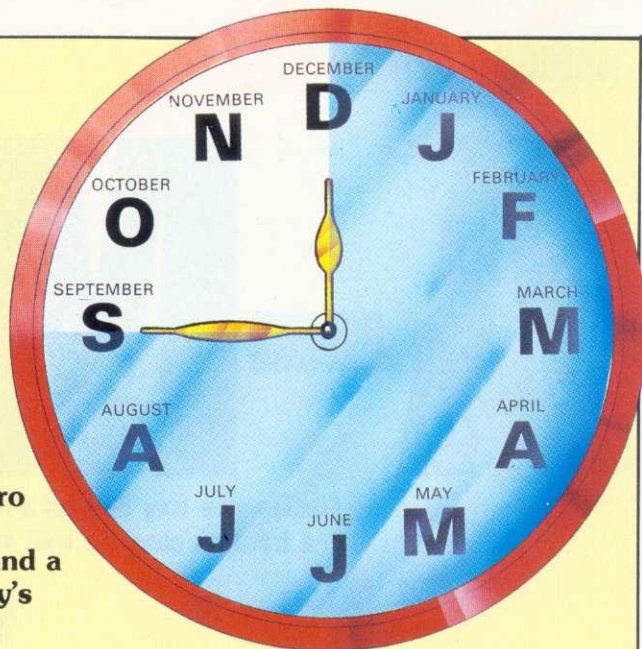

**Renold Building,
UMIST,
Sackville Street,
Manchester**

10am-6pm Friday, September 26
10am-6pm Saturday, September 27
10am-4pm Sunday, September 28

EASY RAIL TRAVEL!

300 yards from Piccadilly railway station, with speedy connections from all parts of the North, Midlands and Wales.

EASY COACH TRAVEL!

Bus and coach stations serving all parts of this vast region are just a short walk from the UMIST campus.

EASY PARKING!

No problem finding somewhere to park - either within the campus itself or nearby car parks.

- ★ *Listen to Acorn experts talking about all the exciting new developments coming from Cambridge!*
- ★ *Watch demonstrations from the BBC showing how to capture Ceefax pages and telesoftware on your BBC Micro.*
- ★ *See for yourself on the big screen the latest advances in music and graphics on the Electron and BBC Micro.*

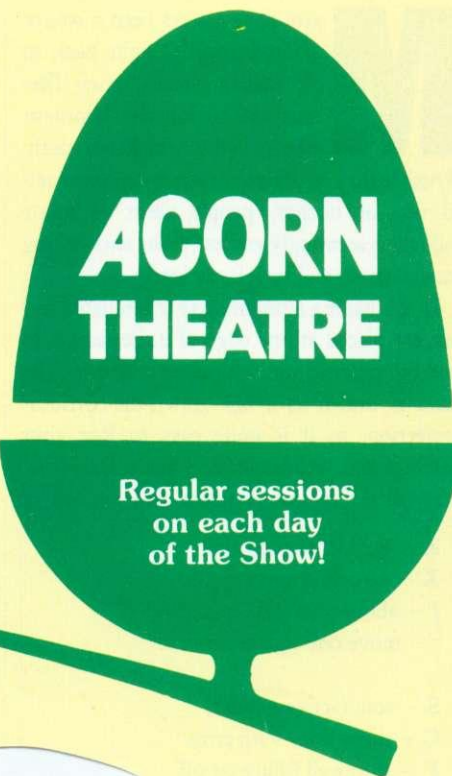

**Avoid the
queues!**

**Get your
ticket in
advance
and...**

**SAVE £1
A HEAD!**

A-MAZE

Finding your way through a maze isn't easy, but when you have to find a treasure chest as well as the exit, then you really are in trouble

David Lawrence

Mazes have always been a source of fascination – right back to the ancient Greeks, when Theseus had to kill the Minotaur whose home was a labyrinth.

Whether they're drawn on paper or constructed out of hedges, people seem to enjoy following seemingly endless paths and getting progressively and hopelessly lost!

In this game a random maze is generated and you are placed at one edge of it: the aim is to find the treasure and, ultimately, the exit. The maze is drawn as a 3D 'down-the-corridor' projection, so it is quite easy to lose your bearings and wander around aimlessly. However, all is not lost: Theseus had his ball of

Z – turn 90 degrees left
X – turn 90 degrees right
 / – about turn (180 degrees)
 : – move one square forward

S – scan (activate radar)
C – mark floor with cross
F – turn wall filling on/off

Table 1. The keys needed to find your way

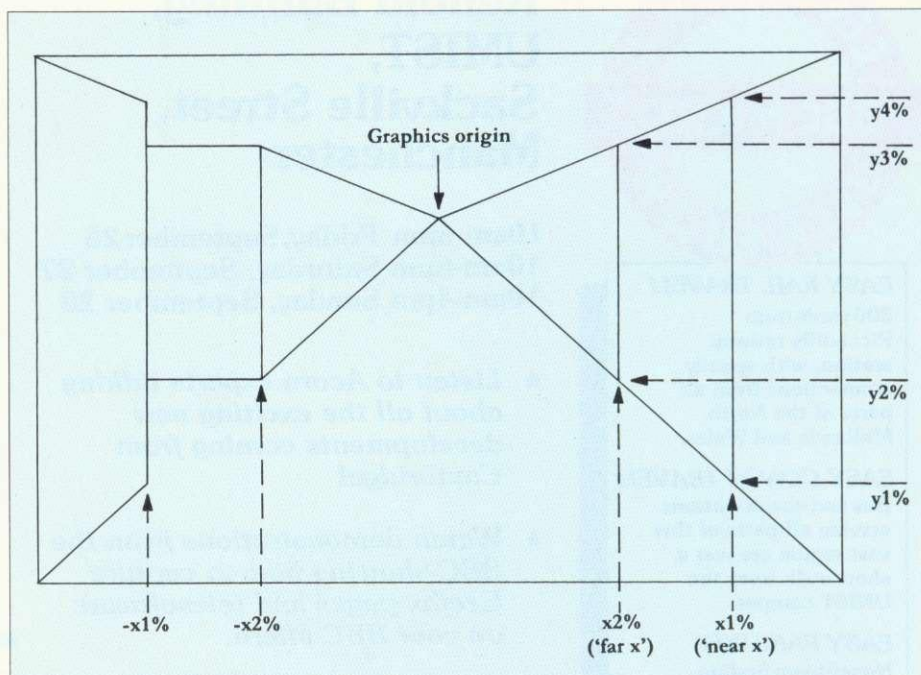

Figure 1. The walls, crosses, etc, can all be drawn in perspective using various X and Y co-ordinates

When you scan, you activate the radar and show you a cross marking an area of the maze with you at the centre. This is useful because you can only use this option

if you are on a simple north-south stroll – a box of treasure, which has been randomly placed within the maze, must be found. If you find the exit and the treasure, you will be told to go back to find it.

ES

Drawing a maze is not as hard as it seems. An array is needed to store the maze. In the case an area of memory is used, a 2D array – to cut down on the amount of memory used. Each location in the array which represents a wall, the array can be read by using the coordinates (x,y) and written to by using (x,y,a) where x and y are the co-ordinates of the point you wish to look at and a is the value you wish to place at that point. The array starts off empty (ie, all wall). A random starting point is chosen, as well as a random

ING



```

.START Set X,Y
.CHOOSE Choose a random direction (1-4)
        Calculate new X and Y
        IF new square outside maze,
            goto CHOOSE
        If new square has already been
        visited, goto JUMP
        Make passage from old to new
        Make X and Y equal to new X
        and new Y
        If all squares visited,
            goto END else goto
        CHOOSE
.END >> END <<
.JUMP Choose a random square
        If it has not been visited,
            goto JUMP else goto
        CHOOSE

```

Table 2. How a random maze is created

direction (1 = up, 2 = left, 3 = down, 4 = right). The array $D\%(D,j)$ contains the values which need to be added to the X and Y co-ordinates to move X and Y in direction D ($j=1$ for X co-ordinates, 2 for Y co-ordinates). The best way to explain the full procedure is by means of a flow diagram: see table 2.

Although the array used is 20 by 20, the maze construction works on a 10 by 10 grid missing out alternate rows and columns. This means that walls are one block thick. This is done to make the 3D views in perspective easier to draw.

When designed, a random exit, start position and box position are chosen. The maze is then ready for exploration.

Three-dimensional views

A set of X co-ordinates corresponding to positions of the side exits is the only data that needs to be stored - all Y co-ordinates are worked out by proportions.

The procedure view (x,y,d) is the main

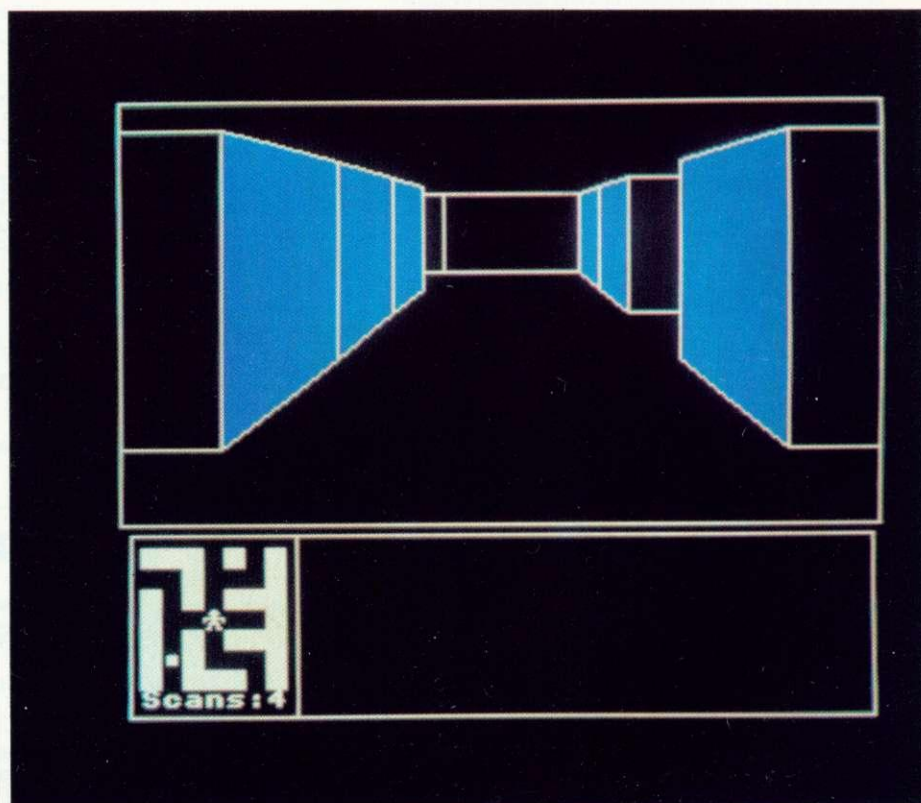

Walls can be coloured in or simple outlines: wall colour can be a navigational aid

routine for drawing what you can see. It produces the 3D view for position (x,y) looking in direction (d). It clears the top area of the screen, draws a border and resets the graphic window. It then calls the function 'room (x,y,d,r)' for each 'room' in front of you until it reaches a blank wall. It will also stop if it has drawn 12 rooms and has not found the end of the corridor; this is because it cannot draw in sufficient detail at this distance. The 'r' in FNroom is the element of the maze array for co-ordinate (x,y), ie, a wall, a cross, etc.

The actual drawing is done by the function 'room'. It 'looks' at the room to the left, the one straight ahead and the one to the right and for each one draws the appropriate wall,

corridor, cross, etc. Each one of these has its own procedure, eg, PROCsidecross. Function 'room' returns either 0 or $N\%+1$. A zero indicates that an end wall has been reached and no more drawing should be done. $N\%$ indicates how many rooms you can see ahead of you, so, if the function returns $N\%+1$, a further room can be drawn. The procedures for drawing the walls, crosses, etc, take the two stored X co-ordinates for the current room (the first is the 'near X', the second is the 'far X' co-ordinate) and calculates Y co-ordinates from these proportionally. Any of the items in the maze can then be drawn by using various Xs and Ys as ordered pairs: see figure 1.

When the next furthest room is needed the

CJEmicro's

ALL CJE MICRO'S SOFTWARE IS B, B PLUS & MASTER COMPATIBLE.

ENHANCED!

Multi-Font NLQ

Converts most printers to NEAR LETTER QUALITY
in user definable Fonts.

For EPSON & EPSON Compatibles, including MX/RX/FX/LX 80/100, STAR DP510/Gemini 10X/SG10/NL10 & Citizen 120D.

Simple to use, standard EPSON codes for Underline and Doublewidth used.

After initialising Multi-Font NLQ with a *MFNLQ, Multi-Font NLQ is normally transparent to the user. Multi-Font does claim some memory for workspace and storing font data. Multi-Font NLQ comprises of MFNLQ ROM for the BBC, and utility disc containing the FONT definer, ten fonts, BASIC demonstration program, VIEW demo text file and Driver.

Multi-Font NLQ is compatible with nearly all software, including most BASIC programs, VIEW, WORDWISE & InterWORD (SCRIBE & Printer Buffer software currently not supported).

Ten fonts are supplied or create your own using the font definer supplied.

Fonts included are:-	Standard NLQ	Bold
	Courier	Shadow
	Italic	Outline
	Gothic	Broadway E.
	CompTS	Theatre

Additional Font Disc MF 'B' contains:- Hand, Script, Stencil, Broadway, Caps, Italic-Plain, Meccano, Plain, STD large, Wire, Greek/Maths and Inverse.

For Canon & Taxan Kaga users we recommend FONTAID in preference to Multi-Font NLQ.

Multi-Font NLQ (ROM and 40/80 Disc)	£30.00
Additional font disc 'MF-B' (12 fonts)	£15.00
P & P on MFNLQ	£ 1.00

This is Standard
This is COURIER
This is ITALIC
This is GOTHIC
This is COMPTS
This is BOLD
This is SHADOW
This is OUTLINE
This is BROADWAY
This is THEATRE

EXAMPLE OF MFNLQ FONTS

Additional disc 'A' gives an extra 11 fonts including:- Greek/Maths, Plain, Hand & (Elite, Condensed, & Super Condensed).

Now included is a facility to issue * commands within a VIEW document. To download new fonts within VIEW documents, the FONTAID ROM needs to be fitted in the BBC. (All other FONTAID facilities are available on both the FONTAID ROM & DISC). Fonts are always downloaded from Disc.

FonTaid is recommended to Canon & Taxan Kaga owners in preference to Multi-Font NLQ. As downloadable NLQ is a built-in facility of the Printer, full access to all the printers control codes is still allowed. The resolution of the FONTAID NLQ is also slightly higher than that of Multi-Font NLQ.

FONTAID requires 6264 RAM chip in printer.

FONTAID ROM & STD Font disc	(40 or 80 track)	£30.00
FONTAID ROM & STD Font disc with 6264 RAM	(40 or 80 track)	£36.00
FONTAID Additional Font DISC 'A' (11 fonts)	(40 Or 80 track)	£15.00
FONTAID Additional Font DISC 'B' (13 fonts)	(40 or 80 track)	£15.00

FONT ROMS of individual fonts are available eg "Square".	£18.00
P & P on FONTAID	£ 1.00

FONTAID

NLQ Definer for Canon & Taxan Kaga NLQ Printers.

Design your own NLQ Fonts or 'download' one of our 40+ predefined fonts.

Fonts can be downloaded within Wordwise, Inter Word or VIEW Documents allowing different fonts to be used for different paragraphs, or even individual lines of text. During downloading your Program or Text will not be corrupted.

On the FONTAID standard font Disk are the following eight fonts:- Square, Outline, Italic, Gothic, Computer Type Style, Bold, Shadow, and Broadway Engraved.

INFORM

A UNIQUE NEW POWERFUL USE FOR SIDEWAYS RAM

INFORM has been developed specifically to take full advantage of the Sideways RAM facility that many BBC micro users now have. Inform is compatible with most SIDEWAYS RAM units including ATPL Sidewise with RAM, Solidisc SWR, BBC B PLUS 128K & BBC MASTER series.

INFORM is a very powerful facility, which allows the user to display text information, of any kind, from Sideways RAM. This information can be readily accessed by using * commands from the keyboard or from application programs. In this way, much information can be displayed on the screen without stopping the current task, such as entering text in WORDWISE or VIEW.

The information in the RAM can be changed dynamically at any time.

Some of the possible applications for INFORM are:-

An on screen help manual can be created for your application, so that a reminder about more obscure points can be displayed at the users request. Information on your program or datafile contents, can remind you of their purpose.

Address and/or telephone numbers can be held and displayed quickly even while other applications are running. Very useful if you need to quickly display information about a client while he is hanging on the end of a phone!

Current prices for your products or stock position can be recalled instantly and readily modified using a wordprocessor. Similar files may be created from most databases such as VIEWSTORE.

In fact, any information to which you frequently refer can be displayed immediately without running another program. Your use of INFORM is only limited by your imagination, as they say!

There are three Inform Data Files (I.D.F.), of often used information, supplied on the disk to give an indication of the use of INFORM.

To use INFORM you must have Sideways RAM.

INFORM on 40/80 track disc. P & P on INFORM £1.00 £20.00

NEW

PRINTERS

NOW FREE DELIVERY on PRINTERS (by courier)

Ring for sample printouts, full specification and latest prices.

Near Letter Quality Printers all with Centronics interface, Friction and Tractor feed.

Canon PW1080A	£270.00
Canon PW1156A (15" printing)	£414.00
Citizen 120D	£180.00
JUKI 5510	£260.00
JUKI 5520 Colour Printer	£430.00
Letter Quality Printer	
JUKI 6100 Daisywheel (20 C.P.S.)	£300.00
BBC Cable	£ 8.00

Inclusive of
VAT & Delivery
Ring for
latest prices.

CJE BBC Printer PACKS include:-

CABLE to BBC 1.25M, M/C two tone screen dump, Screen text dump, Function key set up program, Function key label printing program, VIEW driver, Character defining program for downloadable character set (draft mode), 100 sheets of paper, Mains plug with 3AMP Fuse, Booklet giving instruction on pack software and general details of using the printer with a BBC.

C.J.E. BBC Printer Packs are £15.00 cassette (£16.00 disc) (e.g. CANON PW1080A with Printer pack £270 + £15 = £285 everything included)

EXPORT ORDERS WELCOME please inquire for delivery cost.

PRICES INCLUDE VAT

Phone/Credit Card and Official Orders welcome.

Full range of Printer, BBC, AMSTRAD & ATARI accessories available. **Official ACORN approved Dealer.**

C.J.E. MICRO'S (Dept AU9) 78 Brighton Road
Worthing W. Sussex BN11 2EN (0903) 213361

CJEmicro's

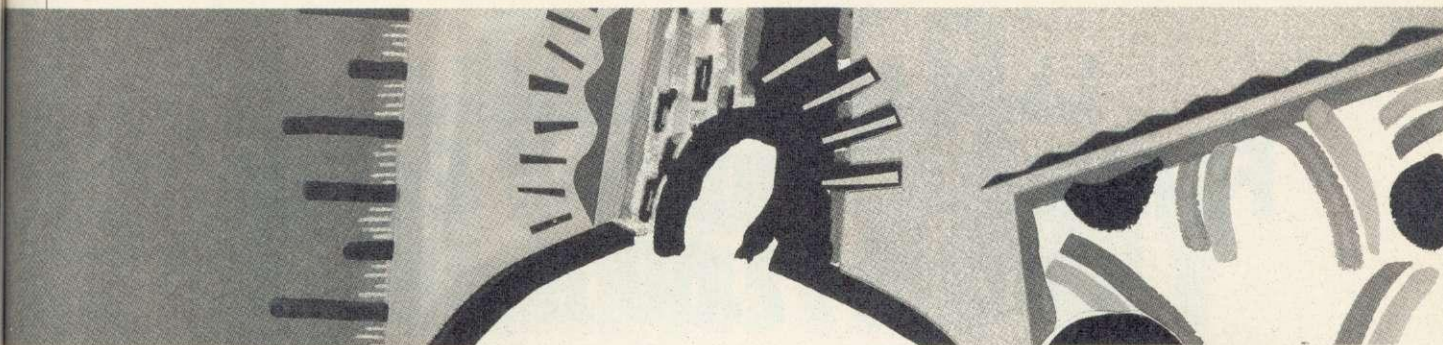

PROCreset	Resets screen and flags
PROCmaze	Creates the random maze
PROCgame	The main game procedure
PROVview	Displays maze from given viewpoint
FNroom	Displays single room
PROCside	Shows specified side of room
PROCwall	Shows a solid wall
PROCopen	Shows a side passage
PROCmove	Detects your keypresses and calls the appropriate procedures
FNforward	Checks if it is possible for you to move forward
FNscan	Performs scan of immediate surroundings
PROCreloc	Relocates program down to &1100 if necessary.

Major procedures and functions

new 'near X' is given the value of the old 'far X' and a new 'far X' is read in. The X coordinates are stored in the array L%(). The walls are coloured using triangles (PLOT 85,x,y). Pressing F simply stops this happening and only the outlines are drawn.

Hints for playing

Many people may know the 'right-hand rule' for finding the way out of a maze. This simply involves placing your right hand on the right hand wall and following this wall round until you get to the exit. This system is fine, and works well, but it does become a bit tedious, especially if you then have to go off and find the treasure!

In this game, the scanner is useful in some situations but, because of its limited range, is not incredibly helpful in others. (Perhaps you may like to extend the range - all the neces-

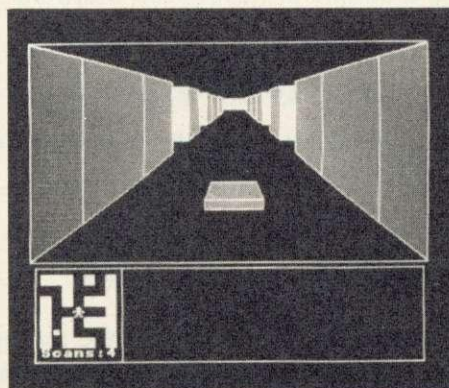

Finding the hidden treasure adds to the puzzle . . .

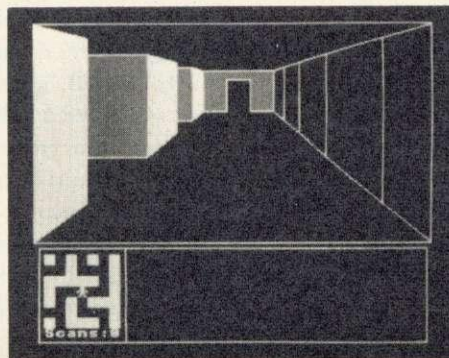

. . . once you've found it head for the exit

saries can be found in 'FNscan'. Clearly then, the chalk is your most useful aid. I use it to mark corridors that are dead-ends. So if I go down a corridor and find a dead-end, I go back to the last junction and mark the entrance to that corridor with a cross and then go down a different corridor from that junction.

This means that if I come to a junction which has all exits except one 'crossed', then the whole of that area must be a dead-end, so I go down that un-crossed corridor until I get to the next junction. This procedure can then be repeated until all the dead-ends have been 'crossed out'. Finding the exit then is easy. Don't forget that the colour of the walls can help you remember where you are.

Improvements and further suggestions

The maze drawing routine always draws a solvable maze, so there is little room for improvement here. However, the start is always on the top wall and the finish always on the bottom wall, so it possible for you to start at the top of a very long north-south corridor with the exit at the bottom!

A routine to find the two points which are furthest apart (ie, the longest path round the maze) would be useful to position the start and end points. Also, if the treasure could be placed down the longest of the dead-ends, the game could be made harder.

As for further suggestions, the basic maze drawing routine can be used as the basis for many other maze games. I have used it for a basic 2D maze where the walls only appear

Array Value	Item in maze
0	Wall
1	Corridor
2	Cross
3	Treasure box
4	Exit

Table 3. The array elements of FNroom

when you hit them, a dungeon inhabited by nasty monsters (a *Dungeons & Dragons* type game), *Pathfinder* (based on the two-player board game of the same name), a 2D hexagonal maze - the rooms are hexagonal rather than square. I am currently developing a 3D 3D maze, in which you see down corridors as in this game, but the actual maze is constructed within a cube!

Acorn User would be interested to hear from anyone who has any further ideas for different maze games.

As a final note, don't forget the chalk, don't get too lost and watch out for the Minotaur!

For David Lawrence's MAZE listing, see the yellow pages index on page 113

CLEVER CALLIGRAPHY

This package of programs enables you to design your own ornamental lettering for a dot-matrix printer, with or without a wordprocessor

Mike Turner

This calligraphy program (listing 1 on the yellow pages) uses a dot-matrix printer to print out ornamental lettering in a style which resembles italic script. It can be used for producing letterheads, notices or handbills – for the school play, perhaps – or legible labels for parcels. Because of shortage of space, only the upper-case (ie, capital) letters and a space are included in the program, but later in this feature you'll find some tips on how to go about designing the lower-case letters and additional styles of letter.

The monthly listings cassette and disc each include a more sophisticated version of this program complete with all the lower-case letters and numerals together with the most frequently-used punctuation symbols, as shown in figure 1. The more comprehensive listing also contains procedures which alter the layout of individual letters within words to give a more balanced look to words such as 'Today', 'July' or 'Adjudication'.

To use the program you will need to create a file of text to be printed – you can either use *View* or the file-creating program provided here (listing 2).

The layout of each line on the page is controlled by certain control codes – what *View* calls edit commands – and the calligraphy program uses four of these:

- CE, which means 'centre this line'
- RJ, 'print this line so that its last letter appears at the right-hand margin'
- MS, 'make all the spaces between words equal in length'
- LJ, 'set the left edge of the print at the left margin' – this is the default setting.

In listing 2, the file-creating program, you use the Shift or Control keys together with any of the red function keys, followed by the code required and the text, in order to control layout. To print text up against the right-hand

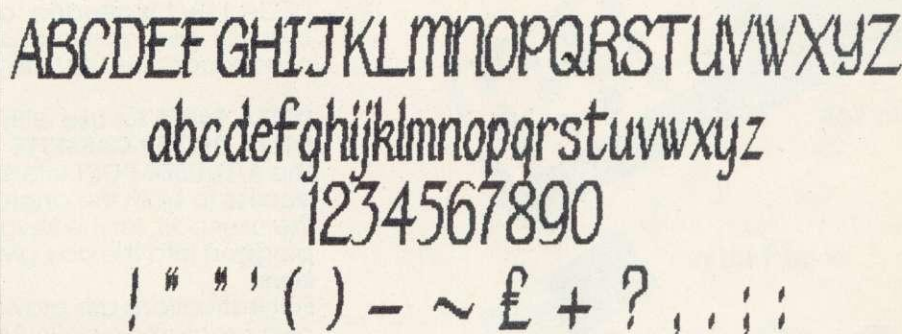

Figure 1. The full set: capitals, lower-case letters, numbers and punctuation

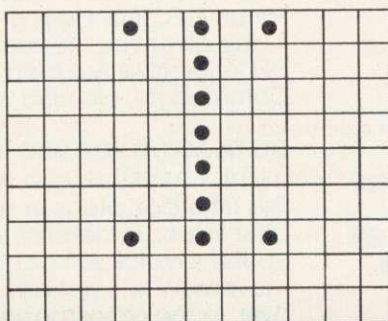

Figure 2. How a dot-matrix printer creates a capital 'I'

- Strikes 1 to 3 are all blank – no wires move.
- Strike 4: Wires 1 and 7 hit the paper. All the rest stay still.
- Strike 5: No wires move.
- Strike 6: Wires 1 to 7 move; 8 and 9 do not.
- Strike 7: No wires move.
- Strike 8: Only wires 1 and 7 move.
- Strikes 9 to 11: No wires move.

side of the print area, for example, type:

Line 1: I'm an Acorn Nut
 Line 2: <Shift f0>RJ and I'm out of my tree
 This will print as:
 I'm an Acorn Nut
 and I'm out of my tree

Lines longer than 60 characters prompt a request to try again. Only 22 lines per file are accepted, as this is the maximum contained on an A4 page, but if, for instance, you would like a scroll of ornamental text instead, feel free to modify this.

When using *View* a few restrictions need to

be observed. Keep the number of characters to a line under a maximum of about 60. Use only the control codes mentioned above. Don't change the default ruler (I use mode 3).

When typing in the main calligraphy program, remember not to renumber the lines containing DATA statements, as otherwise the program will lose track of where to find the data for each letter.

How the printer works

Dot-matrix printers (like my Epson RX80) have a print head with nine fine wires arranged in a vertical column. In the normal text-printing mode, when the printer receives data

JOYSTICKS— THE COMPLETE SOLUTION

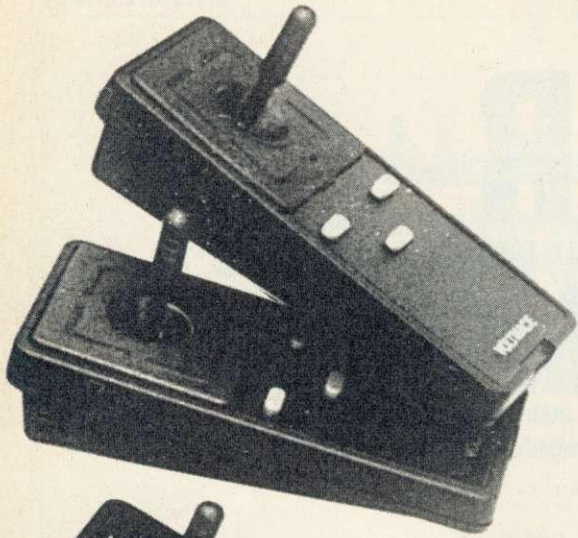

Delta 3B Twin

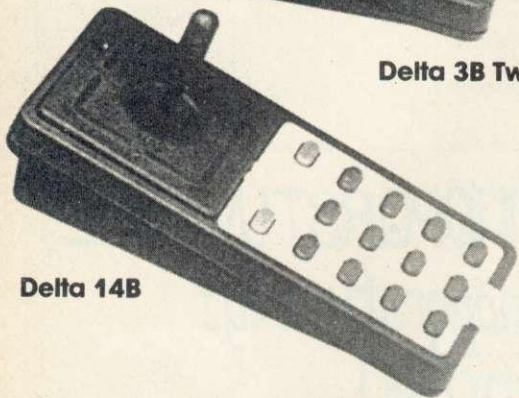

Delta 14B

Delta 14B/1

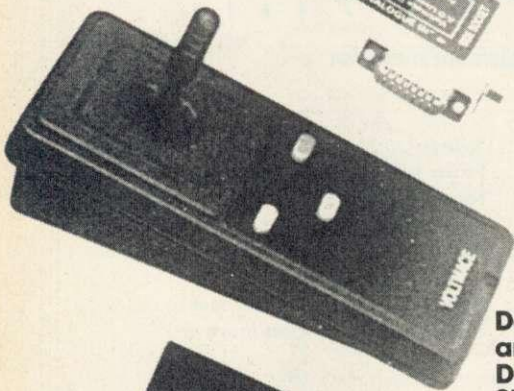
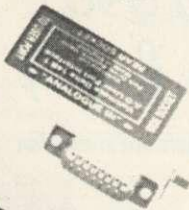

Delta 3S
and
Delta 3B
Single



Datapad 16B

DELTA 3B TWIN—BBC B or ELECTRON PLUS 1 £19.95

A direct but improved alternative for the original ACORN joysticks, with 2 joysticks wired to one plug. As with all our joysticks they have the fast action sprung to centre return of the steel shafted nylon covered joystick. The light action makes them ideal to hold and the 3 fire buttons allow left or right-handed use.

DELTA 3B SINGLE—BBC B or ELECTRON PLUS 1 £12.00

A single joystick that in some ways can act as two. The custom made special "low noise" potentiometers are wired so that it will work as a left hand or right hand joystick. It can even run some programs written for two joysticks and has the fire buttons of both.

DELTA 14B—BBC B £14.95

Our original ACORN/BBC handset. The same super light joystick, but the long life buttons, which have been video game tested for many years, increased to 14 in number. A DELTA 14B/1 is needed to run the keypad but a 14B on its own will work as a joystick and fire buttons, so you can always add the 14B/1 to it later.

DELTA 14B/1 for use with 1 or 2 DELTA 14Bs £14.85 **DELTA DRIVER CASSETTE £5.95**

The A/D/USER PORT interface box. This gives simultaneous access to both the analogue port, for the joystick part and the user port, for the keypad. Two handsets can be plugged into the box giving a total of 24 user definable keys.

Full instructions are provided to include the keypad in your own programs even in BASIC or for the non-programmer a DELTA DRIVER cassette is available with keyboard to joystick/keypad conversions and keypad set up programs.

DELTA 3S (for ELECTRON with switch joystick interface) £12.00

For an ELECTRON with a switched joystick interface (Not a PLUS 1) this gives you the same delightful light, fast action of the DELTA joysticks but fitted with a 9 way D plug as per Atari, Commodore, etc. and will run on First Byte interface or similar.

DELTA ASC/B FOR BBC, DELTA ASC/E FOR ELECTRON PLUS 1 (not illustrated) £9.95

This little box plugs in series with your analogue joystick to alter its characteristics simply by using a switch. In one set up the joystick will act like a switched joystick, i.e. a slight movement will act as if the joystick has been pushed hard over. In the other mode the joystick only covers the centre half of the A/D converter so that it takes twice as much movement to give the same effect. This makes it much easier to make delicate adjustments to programs like flight simulators.

DATAPAD 16B £39.95

A commercial spec. 16 way keypad. Full travel mechanical keys with double shot moulded keycaps mounted in a low profile metal case. The keys are marked with calculator legend, but the software included allows the pad to be defined as any keys, including function keys or single byte VDU commands such as PRINTER ON/OFF. No tampering with the computer as it fits onto the user port.



AA57

Available from your dealer
or direct from us



Voltmace Limited

Park Drive
Baldock
Herts
SG7 6EV
Telephone (0462) 894410

from the computer, it assumes each item is the ASCII code corresponding to a letter, a space, a linefeed, a carriage return, and so on. For instance, if the printer receives the number 73, it goes into a subroutine determined by its manufacturer, and prints out a capital 'I', a column of dots at a time, stepping itself by a tiny amount to the side after each 'strike'. Each standard letter has 11 of these strikes, and for a capital 'I' the sequence is shown in figure 2.

To design the letters used here, I used a printer mode called the 'dual-density bit image' mode. In this mode, if the printer receives the number 73, it doesn't print a capital 'I' at all. Instead the head gives only one strike of the paper, and prints a pattern using only eight of its nine wires, as in figure 3. In fact, if we wanted to produce a replica of our capital 'I' in

printer manuals tend to be rather inscrutable – figure 4, for instance, shows what mine says on the subject (honest!).

It took me a long time to make any sense of this, but what it means in BBC Basic (if not in BBC English) is that in order to put the printer into the correct frame of mind for a whole line of 960 strikes, first send a VDU2 then this statement:

VDU 1, 27, 1, ASC("L"), 1, n1, 1, n2
where n1 = 960 MOD 256, and n2 = 960 DIV 256, calculated previously.

After this, the printer knows that the next 960 bytes of information it is going to get are graphics characters, and after it has received them it reverts to its normal text mode. Therefore, in the main program we have to set up the printer for graphics at the start of each

for each successive configuration of its print wires. But there's a problem: the eight print wires have 256 possible pattern variations for a single strike, ranging from no wires firing (data = 0) to all wires firing (data = 255) and I for one could never learn them all. Fortunately, the solution really is easy – we need to remember only 16 patterns, which are shown in figure 5. To get a column of eight dots, not four, just double them up (figure 6).

Four passes of the head are needed to build up each line of calligraphic print. The first item in each DATA statement gives the number of strikes for each 'storey' of the letter – succeeding items are strings representing the pattern for each strike.

Figure 7 shows how to derive the DATA statements for the letter 'a'. My alphabet was

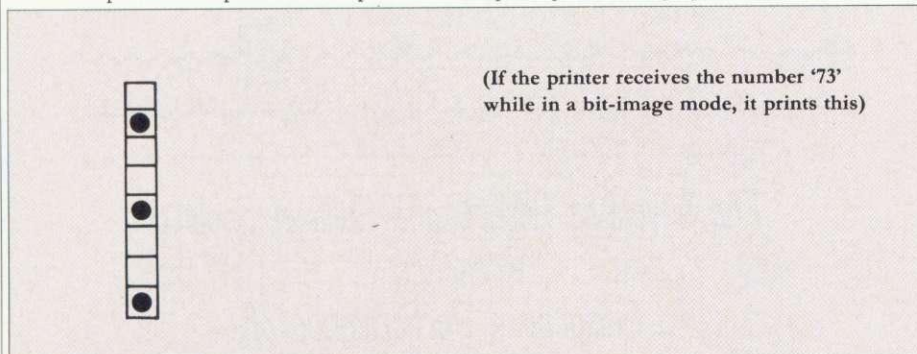

Figure 3. One strike of the paper, using only eight wires

```
Name: ESC L- Dual-density Bit Image Mode
Expression: CHR$(27); "L"; CHR$(n1); CHR$(n2);
CHR$(d1); CHR$(d2); ... CHR$(Dn1, n2)      ◀ Bit-image data
Function: Sets Dual-density bit image mode. (The maximum
number of bit-image data per line is 960.)
```

Figure 4. The impenetrable prose of the printer manual

this mode, we would have to send the printer 11 bytes of data, not just one, like this:

```
10 VDU 2
20 VDU 1, 27, 1, 76, 1, 11, 1, 0
30 FOR strikes = 1 TO 11 : READ data :
VDU 1, data : NEXT
40 VDU 3
50 END
60 DATA 0, 0, 0, &82, 0, &FE, 0, &82, 0,
0, 0
```

Line 20 of the above is the command which puts the printer into the dual-density bit image mode. It tells the printer that the next 11 numbers it receives from the computer should be printed as graphics, not text. It is worth talking about this command for a while, as

pass of the head. Also, we need to adjust the line spacing so that we get neither gaps nor overlaps between passes. The distance between the wires on my printer is 1/72 of an inch. We want the second pass to start where the unused ninth wire would have been on the previous one. The manual talks of a code called ESC A, to set line spacing in units of 1/72"; this translates as:

VDU 1, 27, 1, ASC("A"), 1, 8
The last figure is the one representing the number of units needed – there are eight spaces between nine wires.

Once we have the printer in graphics mode, we can build up patterns of strikes for any shape we like, by sending the printer a number

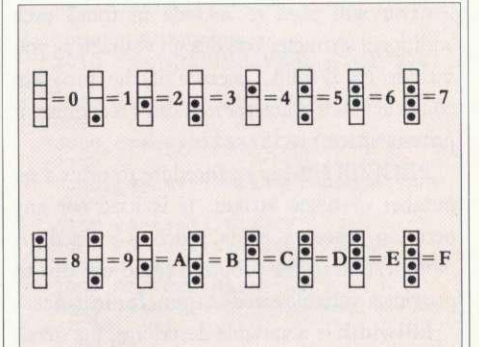

Figure 5. Sixteen patterns to remember

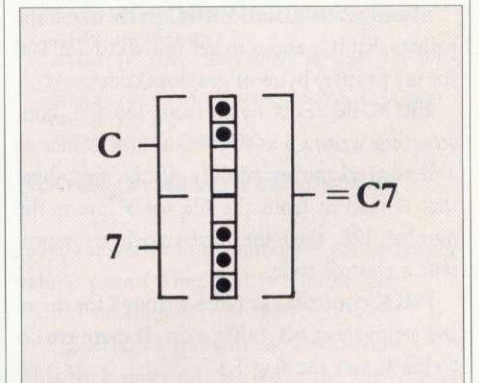

Figure 6. Doubling up for eight dots

designed on grids like this, pencilling in and rubbing out squares until each letter looked about right. I suppose I could have written an on-screen design program but I could use the paper-and-pencil one on the train. Figure 8 shows how 'G' was produced.

Once you have the shape of a basic letter like a small 'a', you'll find it a help in designing others. For instance, a 'd' is not much more than an 'a' with an upright tail, the tail shapes for a 'y', 'j', 'g' are pretty much the same in terms of dot patterns, if not positioning – the 'j' has a different width – and an 'i' is similar in shape to an 'l'. Also, the curves of the left side of the 'a', 'c', 'd', 'e', 'g', 'o' and 'q' are all very similar. If you feel you haven't the eye for

GRAPHICS

designing letters from scratch (like me - I'm still not happy with the 'M' and 'N'), there is an easier way. I subsequently coded another font by using rub-down letters bought from a stationery shop and a photographic enlarger. By sticking the rub-down letters onto a piece of clear film, and projecting this onto a grid of squares - the printer was used to produce this - the outline of each letter was drawn in. If a square looked as though it was more than half covered by the projected shape, it was a 'dot', otherwise it was blank.

Procedures and variables

In general, I have tried to use self-explanatory names for these. For instance, 'font\$', in line 100, contains all the letters for which DATA statements have been compiled.

(You will need to include in font\$ each additional character you design yourself as you include its DATA, because if the program comes across a character it doesn't recognise, it prints a space.)

PROCfill (j%) is a procedure to print a set number of blank strikes. It is used for any occasion where a blank space is needed. A modification to the program could use this to provide a variable-sized margin, for instance.

fullwidth is a variable describing the maximum number of strikes allowed in the dual-density bit image mode.

n1 and n2 are sent to **PROCgrafix** to tell the printer that it is about to get full-width (ie, 960 for my printer) bytes of graphics codes.

PROcfile reads bytes from the file, constructing writing\$ as it goes, until it comes to a Return character (&OD). If the first byte that is read in from the file for a line is the number 128, then the next two bytes represent a control code.

PROccontrols examines writing\$ for these, and strips them off if they exist. If there are no codes, it sets the flag LJ.

PROclayout decides how to respond to the control codes, distributing spaces where needed. It uses the variable 'lead' to decide how many blank strikes are needed at the beginning of the line.

PROcletter chooses which character is due for printing.

PROccentre counts the number of spaces in writing\$ (sp), decides how many strikes (strikes%) are needed to print it, and calculates how many blank strikes (spaces%) are left to fill in each line.

PROcprint reads the DATA, converts the string (dots\$) into a hex number (dots%), and sends this to the printer, adjusting the width of space characters if the flag MS is set, and counting the number of head-strikes to keep track of its position on the line.

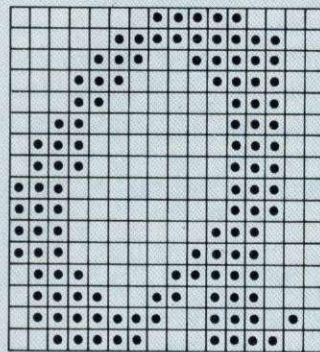

```
3170 DATA 16,0,3,7,1F,38,70
,60,C0,C0,E0,F0,FF,7F,7F,0,0
3180 DATA 16,F0,FE,FF,F,7,3
,3,6,C,18,3F,FF,FF,C1,2,0
```

"a" is 16 strikes side so first item in each DATA statement is therefore 16

For added speed, line number for first DATA statement for "a" can be calculated as $50 * (\text{ASC} "a" - 65) + 1570$ ie, 3170

Figure 7. How the DATA statements for the letter 'a' are derived

```

~~~~~
+++++
The Wivenhoe Gilbert and Sullivan Society
Presents
a Sumptuous Performance of
Their Very Latest and Well-Respected
Comic Opera
~~~~~
"Ruddigore"
~~~~~
To be Performed each Evening
in the
William Loveless Hall
~~~~~
All will be made Most Welcome
~~~~~
Tickets are Now Available
from
all Members of the Society
Price £2~50
+++++
~~~~~

```

Handbill printed by the calligraphy program

CARE ELECTRONICS

OPEN
9am-5pm MON-THU
9am-4pm FRI-SAT

800 ST ALBANS ROAD,
GARSTON, WATFORD,
HERTS WD2 6NL
Tel: 0923 672102

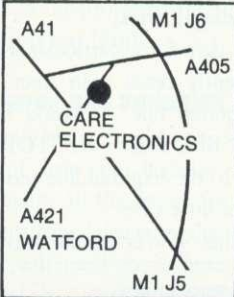

**NEW PRODUCT
AVAILABLE**

MASTER CARTRIDGES

RGB CONVERSION

Philips/Pye & Ferguson TX
Conversion Kit (D.I.Y.) @ £46.00d
Factory Conversion @ £69.00a

READYMADE LEADS

Disc Drive Data (Single) @£6.44c
Disc Drive Data (Dual) @£9.66c
Disc Drive Power (Single) @£3.45c
Disc Drive Power (Dual) @£4.60c
Phono to BNC @£4.60c
Phono to Phono @£2.99c
Phono to UHF @£2.60c
RGB 6-6 pin DIN @£2.99c
RGB 6-7 pin DIN (Hitachi) @£4.14c
RGB 6-7 pin DIN (Ferguson) @£4.14c
RGB 6 pin to SCART (Euro) @£7.82c
Many other types available please telephone or write for details.

ROM EXPANSION

BBC Model B & B+
Low Profile System @£10.81d
Spare Cartridge @£2.07c
Zif Socket Cartridge @£8.05c
Library Rack (Holds 6 Cart) @£1.84c

BBC MASTER SERIES

Master ROM Extender @£9.20c
Will accept CARE or Vigen Cartridges
Master ROM Cartridge @£10.81c
Zif Socket Versions
Master ROM Cartridge (1 Zif) @£16.56c
Master ROM Cartridge (2 Zif) @£21.62c

SWITCHING UNITS

Printer 2 to 1 (Inc Lead) @£34.50d
Printer 6 to 1 @£80.20d
Printer 2 to 2 'CPX2 Buff' @£46.00b
User Port 3 way (Inc Lead) @£37.95d
RS423 2 to 1 @£23.00d
RS232C 2 to 1 'T' @£59.80d
RS232C 2 to 2 'X' @£69.00d



HOW TO ORDER: ALL PRICES INCLUSIVE OF VAT

By Post. Enclose your Cheque/P.O. made payable to CARE Electronics. Or use ACCESS/VISA. Allow 7 days for delivery. Please add carriage.
a = 9.99 b = 5.00 c = 1.00 d = 2.00

DOT MATRIX PRINTERS

Kaga Taxan 810 with NLQ @£247.25a
Kaga Taxan 910 with NLQ @£391.00a
Printer Cable 1mt @£7.82c
Printer Cable 1.5mt @£9.20c
Ribbon Hi-Sec KP-R @£6.90c

FLOPPY DISCS

3.5" (each) @£3.91c
3.5" (per 10) @£33.10c
5.25" S/S D/D (per 10) @£12.65c
5.25" D/S D/D (per 10) @£13.80c

OTHER PRODUCTS

Eprom 2764 250n/s 8K @£2.53c
Eprom 27128 250n/s 16K @£3.45c
Acorn DNFS Interface kit @£69.00c
Wide range of Connectors
Wide range of Semiconductors

MONITORS

(Price inc lead)

Philips Monitors
BM7502 Green Hi-Res @£89.70a
BM7522 Amber Hi-Res @£92.00a
CM8533 Colour Med-Res @£289.80a
Hantarex Monitors
HX-12 Green Hi-Res @£79.50a
CT9000 Colour Med-Res @£199.50a

TV/MONITORS

(Price inc lead)

Philips CF1114 14" @£197.80a
Philips CT2016 16" @£276.00a
Philips CT2216 16" Remote @£310.50a

POWER SUPPLIES

For use with Disc Drives @£27.60b
Single 1 x BBC Outlet @£28.75b
Dual 2 x BBC or D/D Outlets
For Use With most peripherals @£34.50b
Quad 4 x BBC Outlets



ICE - BOX

The amazing **NEW** utility for
sideways RAM

LOOK AT THE FACILITIES

- Transfers 98% of all tape software to disc (inc. specially formatted tapes that other systems cannot handle).
- "Save game" to disc at any point irrespective of filing system selected.
- Freeze frame, slow motion (9 speeds), single step (5ms at a time) at any point in a program.
- Swap between any number of concurrent activities each with their own screen or screen window.
- Change OS functions while a program is running (e.g. sound on/off).
- Allows screen dumps to be made without affecting the current program.
- Works with all disc filing systems, both single and double density.
- Comprehensive 32 page manual.
- Simple "menu" operation plus "star" commands.

Requires:
BBC/B with OS 1.20
disc drive and
16K sideways ram

PRICE £18
(inc. VAT, P&P)

Supplied on disc in 40/80 track compatible format

Send orders to:

**EVENT ONE LIMITED, 89a Newtown Road, Malvern, Worcs.
WR14 1PD. Tel: (06845) 65671.**

Termite

BBC μ
Precision Analogue Control Station

- Precise action Joystick utilising an entirely electronic angle sensing technique.
 - Low friction - Backlash free - Self centering.
 - Zero sensor wear rate.
 - Outstanding durability - Lifetime 10 Million cycles.
 - Span Set Controls - Movement sensitivity adjustable within a nominal 0.5 to 2.0 range - X and Y axes independent.
 - True centre zero adjustment - Calibration program included.
 - Converter reference lock eliminates stick drift.
 - Twin auxiliary rotary controls allow additional parameter adjustment within running program - Fine resolution plastic track potentiometers - Double as second joystick channel.
 - Remote Fire and Secondary buttons in compact handheld unit on coiled cable - Positive switch action.
 - Analogue Port connection - Standard configuration - BBC powered.
 - Robust aluminium and steel case in BBC colour - Utility handle.
 - Compatible with all BBC models.
 - Applications: Industrial - Educational - Serious Home User.
 - Full technical and application details supplied - available separately on request.
- Price: £109.00 (incl. p. & p.). Please allow 28 days for delivery
Cheques should be made payable to: Wee Beastly Electronics.



**Wee Beastly
Electronics**

30 Gladstone Avenue Loughborough
Leicestershire LE11 1NP Tel: (0509) 236805

MICROWORLD

LONDON: 01-627 4840 BIRMINGHAM: 021-236 7772

COMPUTERS

MASTER 128	P.O.A.
Complete with internal software	£113.95
Master Turbo Upgrade	£46.00
Master Econet Module	£373.75
Master ET	T.B.A.
Master 512 Upgrade	T.B.A.
Master SC Upgrade	T.B.A.
Eprom Cartridge	£14.95
Reference Manual Part 1	£14.95
Reference Manual Part 2	£179.00
6502 Second Processor	£379.00
Z80 Second Processor	£125.00
Acorn Prestel Adaptor	£135.00
Acorn Teletext Receiver	£1200.00
Winchester Disk Drive 10 MBYTES	£1860.00
Winchester Disk Drive 30 MBYTES	£299.00
IEEE Interface	£178.00
Music 500	

ECONET ACCESSORIES

100 in Cable	£89.00
Station Lead Set	£29.00
Econet Starter Kit	£99.00
Econet Bridge	£199.00
Level 1 FileServer 40 Track	£99.00
Level 2 FileServer 80 Track	£235.00
Printer Server Eprom	£49.00

MICROWORLD WORDPROCESSING PACKAGE

BBC B Master 128, View 3.0, Viewsheet, Zenith High Resolution Monochrome Monitor, Dual 800K switched disc drives, Juki 6100 daisywheel printer or Star NL-10 NLQ matrix printer (please specify) **WORTH £1292.00**

FOR **ONLY £945** inc Post and Packing.

MONITORS

MONOCHROME MONITORS

Phillips BM 7502 Green Screen	£79.00
Phillips BM 7522 Amber Screen	£95.00

COLOUR MONITORS

Microvitec 1431 Std Res	£201.25
Microvitec 1451 Med Res	£270.25
Microvitec 1441 Hi Res	£391.00
Microvitec 2030 Cs 20 Std Res	£425.50
Microvitec 1431 AP Std Res	£224.25
Microvitec 1451 AP Med Res	£293.25
Phillips CM 8501 STD Res Monitor with Grey Glass screen RGB and Audio Input	£209.00
Phillips CM 8533 Med Res monitor with dark glass etched screen composite video input RGB and Audio input	£289.00
Zenith High Res Green Screen	£79.95
Zenith High Res Amber Screen	£79.95

TAXAN SUPER VISION III

This display is designed for business use which provides both High Res monochrome (Green, Amber and White reverse) mode and High Res Colour graphic mode all in one **£369.00**

TV MONITORS

Phillips 1114 Colour TV Monitor with 14" tube offering 10 preselect channels RF CVBS and RGB inputs	£199.00
---	---------

BBC FIRMWARE

Acorn View Word Processor	£52.00
Acorn Viewsheet	£52.00
Acorn Logo ROM	£65.00
Acorn ISO Pascal	£65.00
Acorn BCPL	£99.00
GXR	£29.00
GXR B+	£29.00
View 3.0	£85.00
LISP ROM	£49.00
BASIC Editor	£28.00
Termulator	£31.95
Microprolog	£69.95

AMX MOUSE AND SOFTWARE

AMX Mouse with super Art ROM	£75.00
AMX pagemaker	£49.95
AMX 3D Zicon	£24.95
AMX Database	£24.95
AMX XAM	£24.95
The original AMX art plus utilities	£14.95
AMX Paintpot	£14.95
AMX Desk	£24.95

BBC UPGRADES

64K Upgrade Kit	£39.95
17170 Upgrade Kit	£49.94
ADFS Rom	£29.95
Disc Upgrade Kit	£89.00
Econet Upgrade Kit	£49.00
Speech Upgrade Kit	£49.00
DNFS Rom	£20.00

STAR NL-10

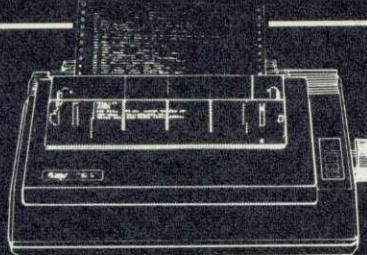

Near Letter Quality, 100% compatibility and total reliability all in one easy to use printer. For quality, ease of operation and dependability, nothing beats the STAR NL-10. You get outstanding print quality at 120cps in draft mode and 30 cps in near letter quality. Plus, the sleek NL-10 offers full compatibility with most popular computers through plug in interface cartridges

WAS £289

NOW

Add £30 for BBC Interface

£228

EPSON LX80

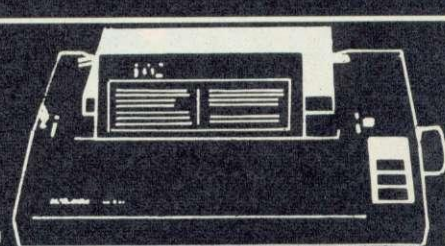

With 100 cps draft and 16 cps nlq and optional tractor adaptor and sheet feeder. This printer has a standard parallel connection and accepts all other Epson serial Parallel boards with external dip switches for easy access and internal 1K buffer. It offers a high specification at a low price.

WAS £250

NOW

£229

JUKI 6100

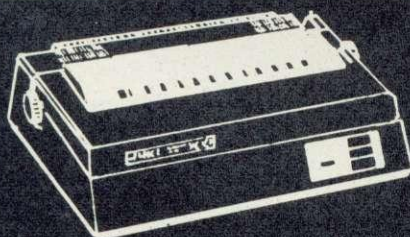

FEATURES
1. 18 cps
2. Standard Daisywheel — Triumph Adler Compatible
3. Diablo 630 protocol
4. Tractor and Sheet feed available
5. Free carriage by Securicor.

WAS £399

NOW

£229

CITIZEN 120D

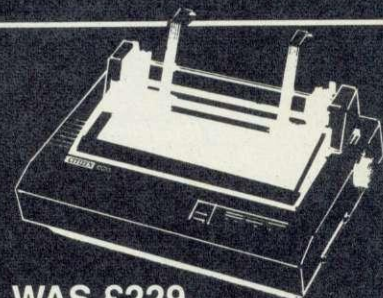

This new Citizen 120D with 120 cps and 25 cps NLQ comes with tractor and friction feed as standard. IBM and EPSON compatible with two years warranty.

WAS £229

NOW

£179.50

MICROWORLD

LONDON: 01-627 4840 BIRMINGHAM: 021-236 7772

MASTERFUL OFFERS FROM MICROWORLD

ACORNSOFT

DISC GAMES WORTH £120.00

10

FOR

£19.99 INC. VAT

Make no mistake this offer is yet another Microworld exclusive. No where else will you find all this quality disc software for so little. All the games discs are both 40 and 80 track compatible and therefore suitable for use with any 5 1/8" disc drive and your BBC B Computer. This means that each disc cost you only £1.99 each, we doubt you could buy quality blank discs at that price. Here are the titles from which we will send you a random selection of ten:

- | | |
|----------------------|---------------------|
| 1 QUEST | 13 HOPPER |
| 2 MONSTERS | 14 CAROUSEL |
| 3 SNAPPER | 15 KINGDOM OF HAMIL |
| 4 ROCKET RAID | 16 CRAZY TRACER |
| 5 SPHINX | 17 DROGNA |
| 6 METEORS | 18 FREEFALL |
| 7 ARCADIAN | 19 METEOR MISSION |
| 8 PLANETOID | 20 BOXER |
| 9 SUPER INVADERS | 21 TETRAPOD |
| 10 FIREBUG | 22 VOLCANO |
| 11 COUNTDOWN TO DOOM | 23 BLACK BOX |
| 12 STARSHIP | |

1
OFFER

BBC Master 128K
100K 40 track disc
drive, pack of 10
Acornsoft disc games
worth £120 and free
carriage by
Securicor.

WORTH £724.95

FOR

INC. VAT

£519

4
OFFER

BBC Master 128K
Dual 800K switched
disc drive with psu,
10 pack of Acornsoft
disc games, free
carriage by
Securicor.

WORTH £926.95

FOR

INC. VAT

£699

2
OFFER

BBC Master 128K
400K single disc
drive, pack of 10
Acornsoft games and
free carriage by
Securicor.

WORTH £775.95

FOR

INC. VAT

£569

5
OFFER

BBC Master 128K
Star NL-10 NLQ
Matrix dot printer or
Juki 6100 Daisywheel
with cable and free
carriage by
Securicor.

WORTH £788.00

FOR

INC. VAT

£679

3
OFFER

BBC Master 128K.
Pack of 10 Acornsoft
games worth £120.
Free carriage by
Securicor.

WORTH £627.00

INC. VAT



Please telephone for our latest price.

6
OFFER

BBC Master 128K
Star NL-10 NLQ
Matrix dot printer or
Juki 6100 printer, with
cable and free
carriage by Securicor
and single 400K disc
drive and pack of 10
Acornsoft disc
games.

WORTH £1,180.95

FOR

INC. VAT

£779

MICROWORLD

· LONDON: 01-627 4840 BIRMINGHAM: 021-236 7772 ·

MITSUBISHI DISC DRIVES

* Add £69.00 for 8271 DFS Kit with DNFS.
When ordered with Disc Drive.

MW/800SP

MITSUBISHI 5¼" Double-sided 800K dual disk drive 40/80 track switchable with own Power supply. Full two years parts and labour warranty.



PLUS 10 FREE ACORN
SOFT GAMES DISCS
WORTH £120.00

RRP £449.95

£259.95 ONLY *
R.R.P.

MW 400SP

MITSUBISHI 5¼" Double-sided 400K single disk drive 40/80 track switchable with own Power supply. Full two years parts and labour warranty.

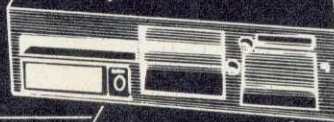

PLUS 10 FREE ACORN
SOFT GAMES DISCS
WORTH £120.00

RRP £289.95

£149.95 ONLY *
R.R.P.

MW 400/S

MITSUBISHI 5¼" Double-sided 400K single disk drive 40/80 track switchable. Powers from the BBC computer. Full two years parts and labour warranty.



PLUS 10 FREE ACORN
SOFT GAMES DISCS
WORTH £120.00

RRP £259.95

£129.95 ONLY *
R.R.P.

MW 100P

MITSUBISHI 5¼" Single-sided 100K single-sided 100K single disc drive 40 track with own power supply. Full two years parts and labour warranty.



PLUS 10 FREE ACORN
SOFT GAMES DISCS
WORTH £120.00

RRP £259.95

£109.95 ONLY *
R.R.P.

MW 100

MITSUBISHI 5¼" Single-sided 100K single disc drive 40 track. Powers from the BBC computer. Full two years parts and labour warranty.



PLUS 10 FREE ACORN
SOFT GAMES DISCS
WORTH £120.00

RRP £259.95

£79.95 ONLY *
R.R.P.

How to Order

Orders by post welcomed: please mail coupon with payment.

Telephone orders welcome.

We also welcome Government and Educational orders.

All products supplied include our own 12 months guarantee backed by our own service centre staffed by fully qualified engineers.

Order with confidence, 7 days money back guarantee.

All prices include VAT and carriage charges by courier.

All items are usually available from stock and are delivered by Securicor Courier Service. Call for availability.

Personal callers are welcome at any of our branches which are open Monday to Saturday — please call for the address.

London — 01-627 4840

Birmingham — 021-236 7772

Edinburgh — 031-228 1111

Glasgow — 041-332 1116

Aberdeen — 0224 571735

MAIL ORDER

To: Microworld Distribution, Dept. AU, Park House, 140 Battersea Park Road, London SW11 01-627 4840 or alternatively 39 Waterloo Street, Birmingham 021-236 7772.

Please send me _____

I enclose a cheque for £..... payable to Microworld Computer Systems Ltd.

Please debit my Access/Visa/American Express Account.

No Signed _____

Name _____ Address _____

FILE IT SIDEWAYS

Beat the 31 files per disc catalogue barrier by using the BBC micro's little-known ROM Filing System

Mike Rawlings

In the March '86 issue of *Acorn User* I looked at the sideways answer to data storage space problems: this month there's more lateral thinking on running longer-than-normal programs, loading disc-based programs at &E00 without a downloader and beating the 31 filenames per disc catalogue barrier.

All this and much more can be achieved using the BBC micro's ROM Filing System, a much under-mentioned and little-used facility. Any file that can be saved on disc or cassette can be stored on a ROM or in ROM-format using sideways RAM. Listing 1 on the yellow pages loads your programs or files, scrambles them into ROM format, stores them in sideways RAM and then (as an encore) downloads them and saves them to disc or cassette. They can then be loaded directly into sideways RAM as and when needed.

Before delving into details of how the Romfile program works and, more important, the best way of using it, a few words on the ROM Filing System.

The ROM Filing System is a close relative of the cassette filing system with a few commands borrowed from the disc filing system. Like the cassette system it has a default page value of &E00 and files are stored in data blocks complete with header blocks, both followed by two bytes containing the Cyclic Redundancy Check (CRC), used for checking for corruption during loading. In addition, all this has to be preceded by the ROM header code – a machine code program that tells the operating system what kind of ROM it is, and which carries out all the boring tasks such as displaying *HELP messages, pointers to where file data is stored and much more. The ROM Filing System does not, of course, support save routines – hence the need for this program. Commands borrowed from the disc system are *TYPE, *LIST and *DUMP – the last uses the normal

disc buffer at &E00. These three commands only exist if the DFS is fitted. Lastly *CAT will, if preceded by *OPT1,2, give full load and execution addresses together with file length.

The Romfile program

Those impatient to put all this into practice can skip this section and start typing immediately. The program produces a Romfile very speedily without the need to understand how it works. For those with more patience, read on.

Probably the best way to explain how the program works is to proceed in running order. First, PROCass assembles three machine code utilities; the first assembled at &70, is a string input routine (using OSWORD with A=0) called from FNinput(x) at line 3540. This limits the length of the input string to x characters. The second (CRC) calculates the Cyclic Redundancy Check with address of data stored at &8B/&8C, length of data at &8F and returns the CRC high byte at &8E, low byte at &8D. At the end of each header or data block the high byte comes first. The third routine (read/write) is used both for storing code and data in sideways RAM and for downloading the finished Romfile ready for saving.

After prompting the user for a Romfile title and asking how much sideways RAM is available, we come to PROCromsetup. This assembles the ROM header code at &3400 and then uses the read/write routine to store the assembled code in sideways RAM. This header code includes the following routines: general *HELP message (help 1), detailed *HELP message (help 2), pointer to start of first file (file), access data (byte), and display message on Break (boot).

PROCmemleft calculates and displays, not the amount of sideways RAM left after the header code, but the largest program that can be stored in this memory allowing for header

blocks, CRCs and block separators. The first file to be stored in ROM format is then *LOADed at &3400 ready for encoding by PROCencode. Note the addresses read in from PROCrdaddr at line 530. PROCencode assembles the encoded file in sideways RAM in the format described in chapter 35 of the *User Guide* with two exceptions. First, header blocks are used before the first and last data blocks only, all other blocks being separated by a single byte containing the value &23. Second, the four spare bytes at the end of the header block contain the address of the first free byte after the file, to help in fast file searches.

The process of *LOADing and encoding is repeated as often as available RAM allows – there is not restriction on the number of files that can be stored on a Romfile. Lastly the end of ROM marker (&2B) is stored in the first free byte after the last file. The completed Romfile is then downloaded to &3400 using read/write and *SAVED. Note that the reload address is &FFFF8000 and not &8000; this is to make the Romfile tube-compatible. The prefix FFFF tells the filing system that the file load address is in the I/O processor, and ensures that it will load correctly with the second processor in use.

Using the program

When the program is run you will be asked for the number of your ROM socket containing sideways RAM, and then a 'Romfile Title' – this is used not only as the name to be displayed on pressing Break but also the filename for saving the completed Romfile to disc or tape. Next enter the size of your sideways RAM (8 or 16). You will now see the maximum filelength displayed at the top of the screen, and you can enter the name of your first file to be stored on the Romfile. It is wise to make a note of the length of files to be stored in advance, to avoid the 'This file is too long'

message. On pressing <Return> the file will be loaded from cassette or disc and then a display will count down the blocks being saved into sideways RAM. If you answer Y to the 'any more' prompt the new maximum filelength will be displayed and you can repeat the process until there is insufficient room for more. Typing N instead will save the completed Romfile - have a blank tape or disc ready.

Using the Romfile

Having saved the Romfile you can reload it into sideways RAM with *RLOAD if you have *Acorn User's* UserRAM. With Solidisk and some other systems you should *LOAD <filename> followed by <Break>, or just *<filename> (bank 15 only). To access the files stored on your Romfile type *ROM <Return>, to select the ROM Filing System, then LOAD, *LOAD, CHAIN, *RUN, *CAT, etc, as usual. As mentioned above, the ROM Filing System works quite happily with PAGE set at &E00, so disc users can load and run programs directly at this address without the need for slow downloader routines.

The number of files that can be stored on one Romfile is limited only by the available sideways RAM, so it is possible to save as many files in Romfile format on disc as there is available memory. The largest file that can be stored on an 8k sideways RAM is 7.42k, and on a 16k RAM, 15.33k. Even using double density systems memory will run out well before you get the dreaded 'catalogue full' message.

Running long programs

Using the Romfile system, text and Basic subroutines can be shifted into sideways RAM. First subroutines - any number of these can be stored in sideways RAM and *LOADed as needed. The speed and ease of use of the ROM Filing System makes the technique of appending program blocks practical for cassette users.

The easiest way to demonstrate the technique is to store two small subroutines on a Romfile and then *LOAD them in turn. First type this short program:

```
10 PRINT "SUBROUTINE 1"
20 PROCtest
30 PAGE = &1900:RETURN
```

Then save it under the name "SUB1". Next change line 10 to:

```
10 PRINT "SUBROUTINE 2"
```

and save the result under the name "SUB2".

Now use the Romfile listing to store these two subroutines on a Romfile called "SUBS". Now type:

```
PAGE = &1900 <Return>
```

```
NEW <Return>
```

and enter listing 2 on the yellow pages, save as "MAIN" and then run. You should see:

```
SUBROUTINE 1
```

```
PAGE = &1100
```

```
SUBROUTINE 2
```

```
PAGE = &1100
```

```
MAIN PROGRAM
```

```
PAGE = &1900
```

```
>
```

Note that the load address of the subroutines in this example is &1100 - this is so that on exit from the subroutine the Disc Filing System

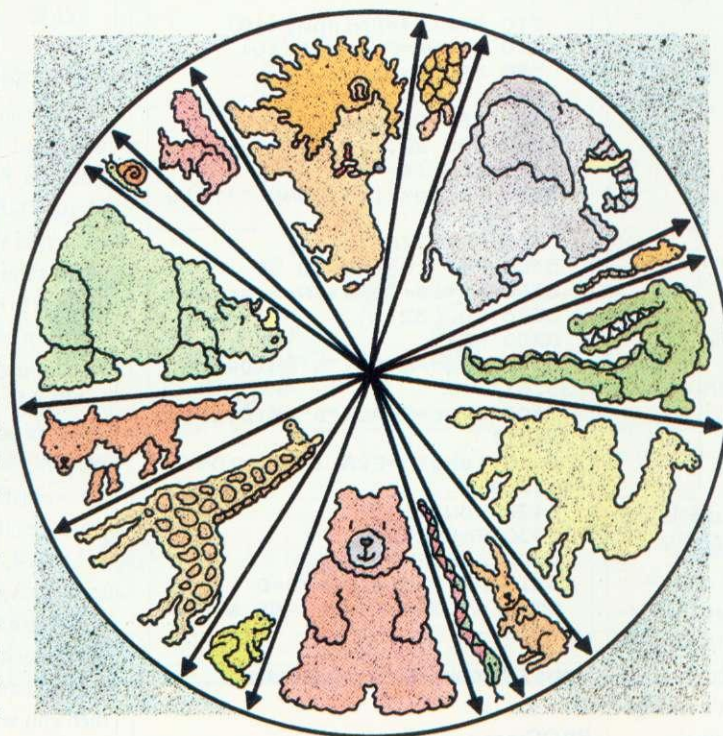

will still operate normally. Using lower addresses will cause a 'fatal error' when you next try to access a disc. However, this still leaves a maximum subroutine size of 2k. On no account try to access disc files from subroutines loaded at these addresses.

Larger subroutines can be *LOADed below the main program by loading the main program at a higher page setting. Alternatively a space can be allocated for the subroutines above the main program by setting LOMEM to a value higher than TOP. For example, make the following alterations to "MAIN" (listing 2):

```
5 LOMEM = &2800
150 PROCoscli("LOAD "+a$+" 2000")
170 PAGE = &2000
```

The subroutine space has been allocated between &2000 and &2800 and will work as before providing that TOP is lower than

&2000.

The other option is to lower HIMEM and load the subroutines above HIMEM:

```
5 HIMEM = &2800
150 PROCoscli("LOAD "+a$+" 2800")
170 PAGE = &2800
```

This is probably the safest option as there is no chance of the subroutine corrupting variable or program memory.

Any procedures or functions in the main program can be called from these subroutines providing they are initialised first (line 20). Subroutines in the main program can also be used providing you reset PAGE before and after the GOSUB command:

```
PAGE = &2800:GOSUB200:
```

```
PAGE = &1900
```

Finally text - if you use the Disc Filing System and your programs contain a great deal of text, you can *BUILD a textfile or better still use *Wordwise* or *View* to create a spooled file, then store this on a Romfile. The text can then be called up from sideways RAM using the *TYPE command. This technique shortens the Basic program by more than the length of the textfile as all the Basic commands used to print the text are dispensed with. I use this method mostly for displaying menus in multi-menu programs and I occasionally *LOAD complete screen displays from sideways RAM.

There is no reason why text files and subroutines cannot be combined on one Romfile, and also no reason why the memory above the Romfile cannot be used

for data storage using the programs given in March's article. The next free address can be found by typing PRINT P% immediately after the Romfile has been saved.

I will finish with a pair of short auto-loader programs (listings 3 and 4) that will *LOAD the Romfile "SUBS" into bank 14 and then CHAIN the program "MAIN".

Entering the program

Type in as listed with PAGE set at &1200 then save. If the program is RUN at a higher PAGE setting, it will automatically relocate itself to &1200. So it saves time if you set PAGE = &1200 before running.

Checksum values

The program incorporates its own checksum routine. To test this, after first saving the program, RUN it, entering "TEST123" as the

UTILITIES

'Romfile title'. (The ROM size doesn't matter.) The program will report back whether the code has been entered correctly or not.

Testing the program

Carry out the example of appending programs, ie, create a Romfile called "SUBS" made up of "SUB1" and "SUB2". Answer '8' to the question '8k or 16k RAM' - the maximum filelength displayed should be &1DBC.

After loading and encoding "SUB1", the maximum filelength ought to be &1D76 (providing the filelength of "SUB1" is &2B). Answer 'N' after loading and encoding "SUB2", press <space> and after "SUBS" has been saved answer 'N'. This will cause a soft reset and you should see the following display:

```
BBC Computer
Romfile: SUBS
Acorn DFS (if fitted)
BASIC
```

Now type:

```
*ROM <Return>
*CAT <Return>
```

and you should see the programs stored on the Romfile listed:

```
SUB1
SUB2
```

Now type LOAD"SUB1" <Return> and then LIST <Return>.

Possible errors

'Bad ROM': there is an error in the ROM header code - check PROCromsetup.

'Data?': there is an error in PROCencode - probably "search" has been calculated incorrectly - or the values poked into !&8B and ?&8F were incorrect before CALLcrc.

Or why not send for this month's listings disc or cassette and get it right first time?

Program notes

Cassette or ADFS users should alter lines 310 and 510 to:

```
310 title$=FNinput(10)
510 file$=FNinput(10)
```

The program has been tested on both *Acorn User's* UserRAM, the BBC B+ 128, the Master and on a Solidisk system and should work with others. Those readers with UserRAM fitted should enter the appropriate ROM bank number; Solidisk users should use 15.

Procedures and functions

PROCromsetup: assembles ROM header code

PROCass: assembles controlled input routine, 'crc' routine, and 'read/write' routine

FNinput(x): calls controlled input routine and returns string at &C00

PROCmemleft: calculates maximum filelength that can be stored in remaining memory

PROCencode: encodes the file loaded at &3400 in ROM format

PROCblock: assembles header block without CRC

PROCheader: assembles header block with CRC

PROsave: downloads finished Romfile to &3400 and then saves it

PROCequib(n): sideways version of EQUB

PROCequw(n): sideways version of EQUW

PROCequd(n): sideways version of EQU D

PROCequs(n\$): sideways version of EQU S

PROCoscli(n\$): Basic 1 version of OSCLI

```
310 title$=FNinput(10)
510 file$=FNinput(10)
520 PROCtape
530
5300 DEF PROCtape
5310 VDU 28,0,8,39,6
5320 CLS:i$=""
5330 PROCoscli("LOAD "+file
$+" 3400")
5340 PRINTTAB(0,1);
5350 FOR char=0 TO 39
5360 i$=i$+CHR$(FNreadchar)
5370 VDU 32
5380 NEXT
5390 load=EVAL("&"+MID$(i$,
23,8))
5400 exec=EVAL("&"+MID$(i$,
32,8))
5410 length=EVAL("&"+MID$(i
$,15,4))
5420 VDU 26
5430 ENDPROC
5500 DEF FNreadchar
5510 A%=135;X%=0;Y%=0
5520 =(USR(&FFF4) AND &FF00
)/256
```

Listing 2. Amendments for cassette users

PROCmore: any more?

PROCsetequ: sets up parameters for sideways equ PROCs

PROCrdaddr: calculates the file's addresses

PROCreloc: relocating routine.

Variables

title\$: Romfile title

rom: size of available sideways RAM

memleft: maximum filelength

file\$: filename of file to be encoded

load: load address of file to be encoded

exec: execution address of file to be loaded

length: length of file to be loaded

search: address of first free byte after file being encoded

block: number of data block being encoded

address: address of data being encoded

flag: header block flag

blen: length of data block being encoded

bk: sideways bank number

hrc: crc high byte

lrc: crc low byte

control%: parameter block to find file addresses

Romfile listing

Romfile contains both Basic and assembly language sections which need to be entered with care. The listed program will work on a disc based BBC B with sideways RAM, the BBC B+ with sideways RAM, the BBC B+ 128k and Master 128k. Details for conversion to tape based systems follow. Once entered, save to disc (tape) and reload after first setting page to &1200 with:

```
PAGE = &1200
NEW
```

SRAM details

For use on any of the above machines you will need to input the location of your sideways RAM block. For example on the Master 128 the sideways RAM banks are located in slots 4, 5, 6, and 7 and the desired value should be entered when you are requested to do so. If you are in any doubt as to which of the sideways RAM banks are free then typing

```
*ROMS
```

will give you a list of the ROMs present. On the BBC B+ 128, the sideways RAM banks are normally referred to as W, X, Y and Z - these are effectively mapped like the Master's as banks 4, 5, 6, and 7 and should be selected as such. Again *ROMS will list the contents of RAM/ROM banks if you are in any doubt as to which are free.

If you are using a BBC B or BBC B+ 64k then you will have a third party RAM/ROM board in operation. Most multi-ROM boards have the RAM/ROM sockets numbered on them or provide details of socket numbers in the accompanying manual. These should be entered accordingly.

Sideways RAM modules such as the *Acorn User* UserRam fit into a single socket: again refer to the manual to ascertain in which socket the RAM module is located.

Tape users

Listing 2 on this page contains the changes which will need to be made to the program before it will work on a tape based system. These allow the tape catalogue details concerning length, load and execution addresses to be read from the screen after the tape file has loaded. Note: line 530 should be deleted.

Yellow Pages: Mike Rawlings' listings are on the yellow pages. See the index on page 113

COMPETITION

A RAM IN SHEEP'S CLOTHING

Pen your rams and win some ROMs: there's great software to be won for this month's brainteaser

Simon Dally

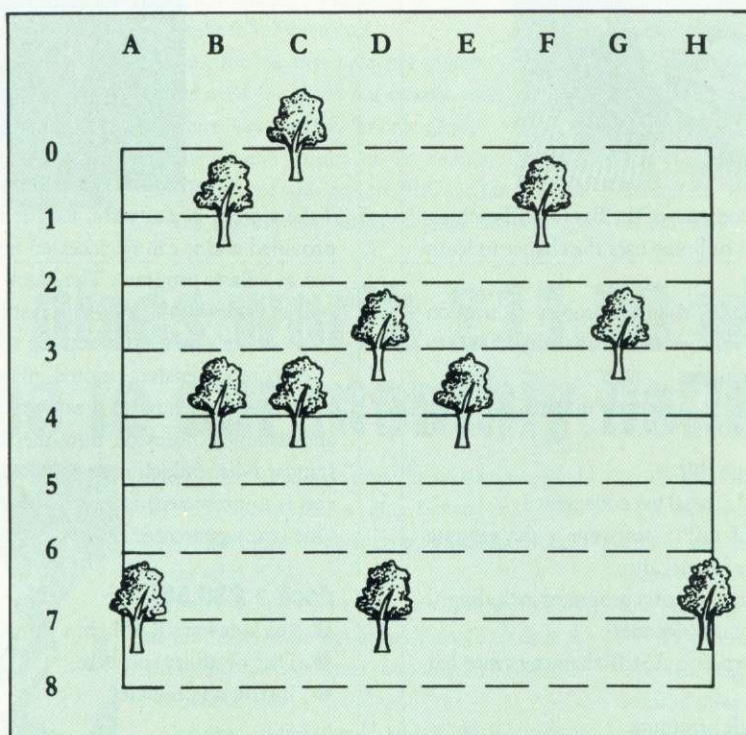

The illustration above shows an open field dotted with trees. You have eleven rams and you wish each of them to have its own enclosure, each with a tree for shelter. You must find the minimum number of fences that are needed to be built to achieve this, bearing in mind the following:

- All fences must be straight;
- Grid numbers are for reference only – a fence may begin and end anywhere;
- Fences may, of course, cross one another.

Draw your fences with a ruler and pen on the diagram and cut it out. Send it, together with your name and address to September Competition, Acorn User, 141-143 Drury Lane, London WC2B 5TF to arrive not later than 22 September.

A photocopy will do if you don't want to cut your magazine, but you must attach the coupon from the foot of the page with your entry.



Win two ROMs and two discs from Clares

The senders of the first five correct entries drawn out of the hat will each receive an exciting pack of Clares software.

There are two ROMs and two discs in the package. *BROM PLUS* is one of the most popular toolkit ROMs around, adding a host of extra commands to your micro to make life

easier, including a full screen editor, finding strings or keywords, search and replace and much more. *MACROM* is a fast macro assembler ROM that allows the use of macros, loaded from a macro library stored on disc. Assembly can be from disc to memory, disc to disc, memory to memory or memory to disc.

Fontwise Plus (on disc) brings you proportional and justified text in 12 different fonts. It's compatible with *View*, *Wordwise* and *Wordwise Plus*. Finally, *Clares Fontwise Editor* disc allows you to design your own fonts for personalised printing.

The whole package would normally cost £114.50 but you can win one free if you draw those fences in the right place!

ACORN USER
COMPETITION
SEPTEMBER

BAR CODE

ACORN USER

Bar code reader teaching pack



Illustrated above are some of the contents of the Bar Code Teaching Pack, designed to give the student or home user the chance to learn about and use bar code technology.

The pack was developed by the Microelectronics Education Programme (MEP) and Addison-Wesley and is available direct to readers of *Acorn User*. The pack includes:

- the bar code reader – which connects directly to your microcomputer
- a user manual written by George Hill
- software to print bar codes and a metal bar code stencil
- a 40-track disc or cassette of utility software – the cassette software can be transferred to 40 or 80 track disc.

The software includes some demonstration programs including:

- using the bar code reader as a binary decoder
- the TELEPEN system for encoding ASCII characters into bar code
- reading programs from bar code printouts
- reading EAN codes at supermarkets checkouts

Also included is a printer driver routine to print out bar-coded listings from Basic.

The total pack costs £83.84 inc VAT and £2.95 postage (£72.90 exc VAT).

Please send me: _____ Bar Code Reader Teaching Packs at £83.84 each inclusive

40 track disc or cassette

I enclose cheque/postal order made payable to Redwood Publishing for £ _____

NAME _____

ADDRESS _____

POSTCODE _____

SIGNED _____ DATE _____ 106-9

Send this form with your remittance to: **Bar Code Offer, Redwood Publishing, 141-143 Drury Lane, London WC2B 5TF**

HA22

USERRAM

ACORN USER

Easy-fit sideways RAM at easy prices!

- 16k ● Fully-compatible with BBC B/B+ ●
- Backed by *Acorn User* ● 3 minutes to fit ● Disc
- Simple for schools ● Ideal for Econet

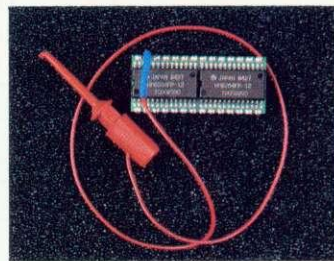

Take a piece of software, load it in UserRAM using the utilities provided and it can be accessed instantly using a '*' command or run as a Basic program. The *Acorn User* UserRAM is as easy to install as a sideways ROM, with just one lead to clip on to the leg of a chip – there's no need to unplug the chip.

A comprehensive printed manual gives fitting instructions, information on how to create your own sideways RAM software and technical notes on how the utilities provided work. Also, a standard disc (which runs on 40 and 80 track drives with any DFS and is unprotected) is supplied with all the basic utilities needed. One year's guarantee is given, with postage and VAT included.

Pack 1 £38.50

- 16k sideways RAM chip with attached connecting lead.
- Disc of utility software.
- Instruction booklet.

Pack 2 £57.95 also contains

- 19 new utilities including printer buffer, *FORMAT and *VERIFY for discs, ROM auto boot, two OS calls and more.
- *BBC Micro ROM Book* by Bruce Smith (published by Collins at £9.95).

Please send me _____ copies of pack 1 at £38.50 each

Please send me _____ copies of pack 2 at £57.95 each

I enclose a cheque/postal order made payable to Frondwood Ltd for £ _____

Please debit my Access card A/c No Expiry date

NAME _____

ADDRESS _____

POSTCODE _____ 106-9

SIGNED _____ DATE _____

Fill in this coupon and send it (or a copy) with your remittance to: **UserRAM, Acorn User, 141-143 Drury Lane, London WC2B 5TF.**

HA23

PROGRAM LISTINGS

ACORN USER OFFERS

September listings on cassette £3.95 or disc £5.95

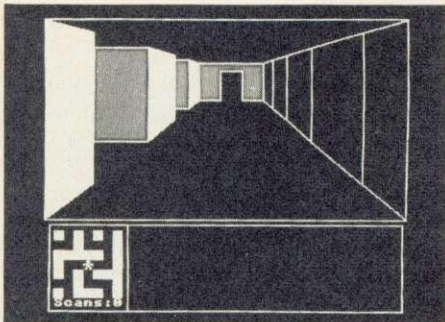

You'll find Maze on the disc and tape

We're featuring three great programs this month: Mike Rawlings' super new sideways RAM utility, David Lawrence's addictive Maze game and Mike Turner's exciting calligraphy program which supports the full character set.

Plus, for the first time this month, there is an added extra for all of you cassette users – a great graphics bonus, and all for only £3.95.

The cassette version of the monthly listings is suitable for use with both the BBC and the Electron.

The monthly disc listings contain our new-style

index and header, and some more graphics screens, a bargain at £5.95.

The discs are supplied in 5.25in 40-track format, and conversion instructions are included for 80-track users. And Electron owners – remember the monthly disc is fully compatible with the advanced Plus 4.

Finally, if you subscribe to the Micronet service, don't forget that you can download the month's disc listings for just £5.00, and you'll avoid the vagaries of the post!

Two free discs worth £11.50 when you subscribe to our monthly listings disc



Digitised portraits in the graphics bonus

Hurry – this is your last chance to take advantage of this really special offer, as after September 30, 1986 we will not be able to accept applications for 14 discs for the price of 12.

Take advantage now and you will receive 14 monthly discs of listings at less than £5.00 each. A real saving, but only when you subscribe before this special offer ends.

Overseas readers should add £7.00 for surface mail (and airmail to Europe), or £15.00 for airmail delivery (to the rest of the world).

The discs contain all the program listings presented in each issue of *Acorn User*, so you don't have to type in the listings from the yellow pages – which saves you time, as well as money. Just load the disc and off you go.

Plus there's an added bonus – each month the discs contain exciting graphics screens, including some of those featured in the magazine. You can see one of these graphics screens pictured to the left.

Back issues of the monthly disc are available from October 1985.

Free cassettes worth £7.90 when you subscribe to our cassette listings

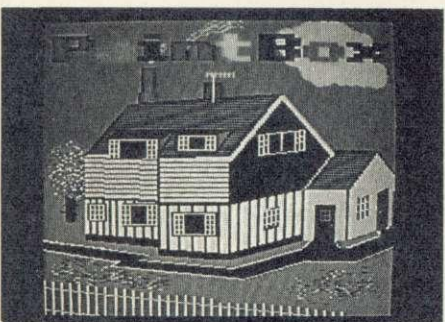

Home sweet home with Rob Fenton's program

This is your last chance to receive a free Graphics cassette and a Best of Acorn User cassette when you subscribe to our monthly listings cassettes, as this offer closes on September 30, 1986.

Our cassette will save you the time and trouble of keying in our monthly listings from the yellow pages, leaving you free to get on and enjoy the month's programs.

And, don't forget, our offer will also give you the time to enjoy your free cassettes.

The Graphics cassette includes: Rob Fenton's

painting program; designing sprites, written by Harry Sinclair; using the colfill and dotfill routines to colour fill, written by Peter Sandford. And what could be more useful than the pie and bar charts also written by Peter Sandford?

When you've finished with the Graphics, why not go on to the Best of Acorn User cassette, a comprehensive selection of 11 of our best program listings, including the Quadline and Picture Slide games, sideways RAM utilities, an all-mode graphics dump, tape to disc transfer and much more besides.

Telephone Orders 01-836 2441 9.30am to 5.00 pm. Ask for Seran. Order form on page 111

MAGAZINES & BINDERS

ACORN USER OFFERS

Three issues free—when you subscribe to Acorn User magazine

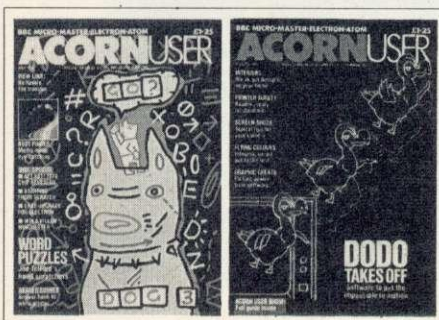

15 magazines for the price of 12

If you've enjoyed reading this issue of *Acorn User*, the biggest and best-selling BBC/Acorn magazine, why not ensure you receive your monthly copy regularly by subscription?

At the same time you'll be able to take advantage of our super special offer, and receive 15 issues of *Acorn User* magazine for the price of 12.

How else can you make sure you are up-to-date with the latest innovations, news, reviews and features. Stay in touch each month with *Acorn User* magazine, the biggest and the best!

You'll find articles covering education, business and home use, and there's a special section for new users. There are articles, hints and listings for all Acorn machines – BBC B, B+, Master, Electron and Atom. In fact, something for everyone.

This offer is only open to readers in the UK and the Republic of Ireland.

If you are an overseas subscriber turn to page 111, so that you can take advantage of our two-year rate offer. We will send you 27 issues for the price of 24, when you pay the two-year price.

Acorn User Magazine Back Issues—£1.75



Classic issues from yesteryear

The following back issues are available by using the order form on page 111:

1984:	May	August	November
	June	September	December
	July	October	
1985:	January	June	October
	March	July	November
	April	August	
	May	September	

1986:	January	April	July
	February	May	August
	March	June	September

Send an A4 stamped addressed envelope for further details of back issue contents of *Acorn User* to Seran Anderson Haddick, Acorn User Merchandise Department, 141-143 Drury Lane, London WC2B 5TF.

Disc Binder and Slip Case £9.95 and Magazine Binder £4.95

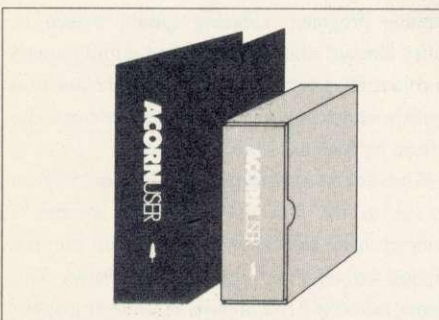

Magazine binder and disc binder

What better way to protect your *Acorn User* monthly disc listings, or your own programs, than in the safety of this fine grey cloth disc binder?

The binder is lined in grey, and has a 30mm capacity, big enough to hold 12 monthly discs comfortably. The spine of the binder features a discreet silver *Acorn User* logo.

Included with the disc binder are six transparent inserts, each capable of holding two 5¼" discs. Last, but most importantly, there is a sturdy slip case, which will protect the binder and the discs within.

Never lose another issue and keep your *Acorn User* magazine collection in style, with this fine red *Acorn User* magazine binder.

The magazine binder features a wide spine with the capacity to hold 12 issues of more than 200 pages. The magazines are held in place with metal strips, which will allow you to fit your monthly magazine with ease.

Keep your precious back issues in safety, filed in order so that you can easily refer to them. You'll find the order form for binders on page 111.

Telephone Orders 01-836 2441 9.30am to 5.00 pm. Ask for Seran. Order form on page 111

SPECIAL PROGRAMS

ACORN USER OFFERS

Acorn User bibliography on disc – from £7.95



A page from the bibliography

If you've ever spent hours looking through your copies of *Acorn User* for an elusive article, which you know you've seen but can't remember when or where, then what you need is the *Acorn User* bibliography!

Our bibliography contains information on where to find games, listings, educational and utility programs; reviews of hardware, firmware, peripherals, software and books; and feature articles of specific and general interest. You'll even find reference to readers' letters!

The *Acorn User* bibliography is sold in parts, in a specially enhanced format, which will make your searches even faster, taking about 15 seconds on the 40-track and 40 seconds on the 80-track disc. Location of a reference is by one- or two-string searching and the user may specify the starting month and year. Output may be to screen or printed.

There are three parts currently available; a further instalment, part 4, will become available later in the year.

Acorn User Gallery Disc – super graphics for only £6.95

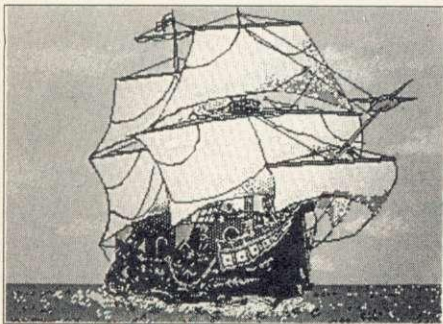

Galley on the Gallery Disc

The *Acorn User* Gallery disc has proved to be immensely popular since its introduction in the August issue. It features an automatic scrolling display of over 20 stunning graphic screens.

What's more, the disc gives you the chance to dabble with a little creativity, by using the Super Painter and Pixel Editor.

These clever graphics creating programs, included on the disc, allow you to alter and edit these pictures as you like, and also give you the chance to concoct your own designs.

You can marvel at Spiderman, see the Coke can come alive, plus Robotic Brilliance, Astronaut, Elite, Wimp Fashion, Max Headroom, Sunrise, Thomas the Tank Engine, and many more screens.

And don't forget you can use our *UserDump* ROM to print all these fabulous screens too!

The Gallery disc is available as a single 80-track disc or two 40-track discs containing over 400k of graphics in under half the disc space, and costing just £6.95.

Graphics Cassette and the Best of Acorn User Cassette – £3.95

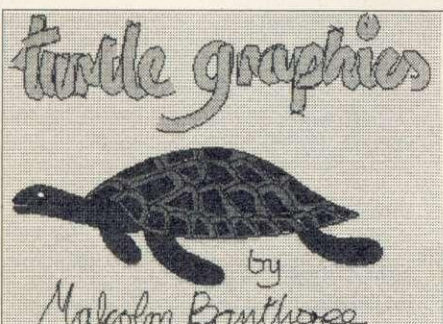

One of the Best of AU

Enormously popular and immensely useful, the Graphics cassette at a bargain price of £3.95 includes the following programs for your delight: Rob Fenton's painting program (Feb 1985), Peter Sandford's Colfill and Dotfill (Jan and Feb 1985) and Harry Sinclair's Sprite designer (Sep, Oct and Nov 1984). And all available on one cassette, suitable for use on the BBC and the Electron.

What could be more useful than the Best of *Acorn User* cassette? A comprehensive selec-

tion of 11 program listings, which includes Malcolm Banthorpe's Turtle Graphics, an easy introduction to Logo; an all screen mode printer dump for Epson and Epson-compatible printers; a bad program recovery routine; a selection of sideways RAM routines, two games, plus much much more! Suitable for use on the BBC and the Electron.

Graphics and Best of *Acorn User* are the first two cassettes in our special cassette range. you'll be seeing further offers later in the year.

HA21

Telephone Orders 01-836 2441 9.30 am to 5.00 pm. Ask for Seran. Order form on page 111

ROMS

ACORN USER OFFER

UserDump and UserROM only £19.95 each

ACORN USER PRINTER CONTROL

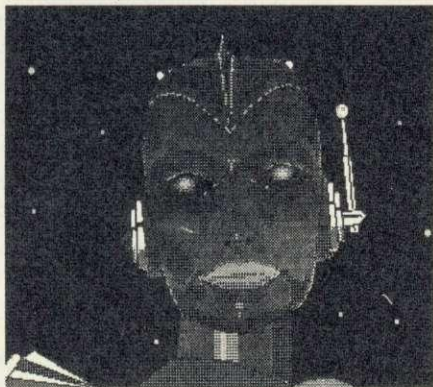

Dump your graphics with UserDump

ACORN USER ON A CHIP

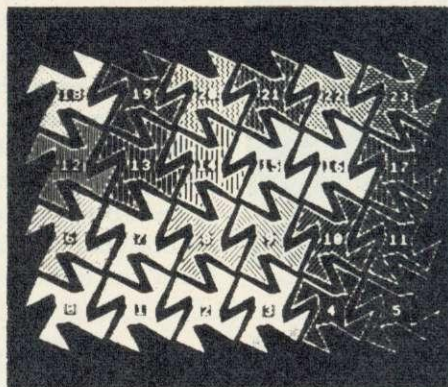

UserROM's dot fill routine

UserDump includes a ROM chip which plugs into any free ROM socket on your BBC micro, and an easy-to-use manual. With *UserDump* you'll have access to a wide range of commands to help you control your printer's facilities – all for just £19.95.

You will be able to dump any screen image in any display mode by entering a single command – either as a line of your program or typed in direct from the keyboard. *UserDump* will also give a perfect dump while a machine code program is running.

UserDump will work with all the popular dot-matrix printers including: Epson MX, RX, FX, JX; Star Gemini, Delta, SG, SD, SR; Canon NLQ; Kaga NLQ. Mannesmann-Tally Spirit 80 and Lucas 80. Plus printers with single and double density bit-image graphics, including CP80 and JX80 colour printers.

UserDump provides commands such as:

- *SDUMP – dumps whole screen in any mode
- *WDUMP – dumps graphics window
- *CDUMP – very fast screen dump
- *TDUMP – dumps text window in any mode
- *WINDOW – defines graphics window from keyboard
- *TRANSTT – converts teletext screen into mode 1
- *LPRINT – directs all print commands to the printer only
- *SHIFT – shifts an area of memory

The *Acorn User UserROM* brings the best of *Acorn User* into your micro. Put together by our technical editor, Bruce Smith, this 8k ROM chip is packed with your favourite *Acorn User* routines. Simply plug the ROM chip into a spare sideways ROM socket and all the routines are instantly accessible via easy-to-use *commands – what could be simpler?

Routines include the popular colour fill and dot fill routines, bad program recovery, variable lister, function key lister, a graphics compiler, a circle drawing routine, a bulletin board, screen compressor, on screen character fonts, ROM lister, sound compiler, plus lots, lots more!

Included with *UserROM* is a 22-page manual which explains in clear simple terms how to get the most from your *UserROM*, and you'll find many demonstration programs showing how to use the new commands.

UserROM gives the following extra commands: *BORDER

- | | |
|----------|-----------|
| *CHECK | *CIRCLE |
| *COLFILL | *COMPRESS |
| *DOTFILL | *EXPAND |
| *EXPLODE | *FKEYS |
| *GOFF | *GON |
| *ITALICS | *MODERN |
| *NORMAL | *PROGRAM |
| *ROMS | *SCREEN |
| *SCROLL | *VARS |

HA24

Telephone Orders 01-836 2441 9.30 am to 5.00 pm. Ask for Seran. Order form on page 112

ACORN USER ORDER FORM

ACORN USER OFFERS

DISC SUBSCRIPTIONS

Yes! I want to take advantage of your special 14 issue offer.

Please start my disc subscription from the Issue

- | | | |
|-----------------------|--------------------------|--------|
| 01 UK | <input type="checkbox"/> | £69.00 |
| 02 EUROPE (Airmail) | <input type="checkbox"/> | £76.00 |
| 02 OVERSEAS (Surface) | <input type="checkbox"/> | £76.00 |
| 03 OVERSEAS (Airmail) | <input type="checkbox"/> | £84.00 |

TOTAL VALUE £.....

CASSETTE SUBSCRIPTIONS

Yes! Please start my cassette subscription from the Issue and send me my free Graphics & Best of Acorn User cassette.

- | | | |
|-----------------------|--------------------------|--------|
| 01 UK | <input type="checkbox"/> | £45.00 |
| 02 EUROPE (Airmail) | <input type="checkbox"/> | £52.00 |
| 02 OVERSEAS (Surface) | <input type="checkbox"/> | £52.00 |
| 03 OVERSEAS (Airmail) | <input type="checkbox"/> | £62.00 |

TOTAL VALUE £.....

MAGAZINE SUBSCRIPTIONS

Yes! Please start my subscription to Acorn User magazine from the

..... Issue

- | | 12 Issues | 27 Issues |
|--------------------------|---------------------------------|---------------------------------|
| 01 UK | <input type="checkbox"/> £17.50 | <input type="checkbox"/> £35.00 |
| 02 EUROPE | <input type="checkbox"/> £25.00 | <input type="checkbox"/> £50.00 |
| 03 MIDDLE EAST | <input type="checkbox"/> £30.00 | <input type="checkbox"/> £60.00 |
| 04 THE AMERICAS & AFRICA | <input type="checkbox"/> £35.00 | <input type="checkbox"/> £70.00 |
| 05 REST OF THE WORLD | <input type="checkbox"/> £40.00 | <input type="checkbox"/> £80.00 |

TOTAL VALUE £.....

ACORN USER MONTHLY DISCS

- | | | |
|-------------------------------------|-------------------------------------|-------------------------------------|
| 1985 | 1986 | <input type="checkbox"/> JUL 0210-0 |
| <input type="checkbox"/> OCT 0201-1 | <input type="checkbox"/> JAN 0204-6 | <input type="checkbox"/> AUG 0211-9 |
| <input type="checkbox"/> NOV 0202-X | <input type="checkbox"/> FEB 0205-4 | <input type="checkbox"/> SEP 0212-7 |
| <input type="checkbox"/> DEC 0203-8 | <input type="checkbox"/> MAR 0206-2 | |
| | <input type="checkbox"/> APR 0207-0 | |
| | <input type="checkbox"/> MAY 0208-9 | |
| | <input type="checkbox"/> JUN 0209-7 | |

UK = £5.95
Europe = £6.95
Overseas = £7.95

TOTAL VALUE £.....

ACORN USER MONTHLY CASSETTES

- | 1984 | 1985 | 1986 |
|-------------------------------------|-------------------------------------|-------------------------------------|
| <input type="checkbox"/> MAY 0401-4 | <input type="checkbox"/> JAN 0409-X | <input type="checkbox"/> JAN 0421-9 |
| <input type="checkbox"/> JUN 0402-2 | <input type="checkbox"/> FEB 0410-3 | <input type="checkbox"/> FEB 0422-7 |
| <input type="checkbox"/> JUL 0403-0 | <input type="checkbox"/> MAR 0411-1 | <input type="checkbox"/> MAR 0423-5 |
| <input type="checkbox"/> AUG 0404-9 | <input type="checkbox"/> APR 0412-X | <input type="checkbox"/> APR 0424-3 |
| <input type="checkbox"/> SEP 0405-7 | <input type="checkbox"/> MAY 0413-8 | <input type="checkbox"/> MAY 0425-1 |
| <input type="checkbox"/> OCT 0406-5 | <input type="checkbox"/> JUN 0414-6 | <input type="checkbox"/> JUN 0426-X |
| <input type="checkbox"/> NOV 0407-3 | <input type="checkbox"/> JUL 0415-4 | <input type="checkbox"/> JUL 0427-8 |
| <input type="checkbox"/> DEC 0408-1 | <input type="checkbox"/> AUG 0416-2 | <input type="checkbox"/> AUG 0428-6 |
| | <input type="checkbox"/> SEP 0417-0 | <input type="checkbox"/> SEP 0429-4 |
| | <input type="checkbox"/> OCT 0418-9 | |
| | <input type="checkbox"/> NOV 0419-7 | |
| | <input type="checkbox"/> DEC 0420-0 | |

UK = £3.95
Europe = £4.95
Overseas = £5.95

TOTAL VALUE £.....

ACORN USER SPECIAL DISCS

- GALLERY 40 track 0801-X
GALLERY 80 track 0802-8

UK = £6.95
Europe = £7.95
Overseas = £8.95

- | BIBLIOGRAPHY | UK | EUROPE | OVERSEAS |
|-----------------------------------|---------------------------------|---------------------------------|---------------------------------|
| 40T - Jul 1982 to May 1984 0851-6 | <input type="checkbox"/> £7.95 | <input type="checkbox"/> £8.95 | <input type="checkbox"/> £9.95 |
| 40T - Jun 1984 to May 1985 0852-4 | <input type="checkbox"/> £7.95 | <input type="checkbox"/> £8.95 | <input type="checkbox"/> £9.95 |
| 40T - Jun 1985 to Feb 1986 0853-2 | <input type="checkbox"/> £7.95 | <input type="checkbox"/> £8.95 | <input type="checkbox"/> £9.95 |
| 40T - Jul 1982 to Feb 1986 0881-8 | <input type="checkbox"/> £21.95 | <input type="checkbox"/> £22.95 | <input type="checkbox"/> £23.95 |
| 80T - Jul 1982 to May 1985 0901-6 | <input type="checkbox"/> £11.95 | <input type="checkbox"/> £12.95 | <input type="checkbox"/> £13.95 |
| 80T - Jun 1985 to Feb 1986 0902-4 | <input type="checkbox"/> £7.95 | <input type="checkbox"/> £8.95 | <input type="checkbox"/> £9.95 |
| 80T - Jul 1982 to Feb 1986 0931-8 | <input type="checkbox"/> £17.95 | <input type="checkbox"/> £18.95 | <input type="checkbox"/> £19.95 |

TOTAL VALUE £.....

Telephone Orders 01-836 2441 9.30 am to 5.00 pm. Ask for Seran.

ACORN USER ORDER FORM

ACORN USER OFFERS

ACORN USER ROMS

- USERDUMP 1001-4
 USERROM 1002-2
- UK = £19.95
 Europe = £20.95
 Overseas = £21.95

TOTAL VALUE £.....

ACORN USER SPECIAL CASSETTES

- ACORN USER GRAPHICS 0601-7
 BEST OF ACORN USER 0602-5
- UK = £3.95
 Europe = £4.95
 Overseas = £5.95

TOTAL VALUE £.....

BINDERS

- MAGAZINE BINDER 1201-7
 DISC BINDER 1301-3
- | | | | |
|--|--------------------------------|---------------------------------|---------------------------------|
| | UK | EUROPE | OVERSEAS |
| | <input type="checkbox"/> £4.95 | <input type="checkbox"/> £7.95 | <input type="checkbox"/> £14.95 |
| | <input type="checkbox"/> £9.95 | <input type="checkbox"/> £12.95 | <input type="checkbox"/> £19.95 |

TOTAL VALUE £.....

ACORN USER MAGAZINE BACK ISSUES

- | | | |
|-------------------------------------|-------------------------------------|-------------------------------------|
| 1984 | 1985 | 1986 |
| <input type="checkbox"/> MAY 0013-2 | <input type="checkbox"/> JAN 0021-3 | <input type="checkbox"/> JAN 0032-9 |
| <input type="checkbox"/> JUN 0014-0 | <input type="checkbox"/> MAR 0022-1 | <input type="checkbox"/> FEB 0033-7 |
| <input type="checkbox"/> JUL 0015-9 | <input type="checkbox"/> APR 0023-X | <input type="checkbox"/> MAR 0034-5 |
| <input type="checkbox"/> AUG 0016-7 | <input type="checkbox"/> MAY 0024-8 | <input type="checkbox"/> APR 0035-3 |
| <input type="checkbox"/> SEP 0017-5 | <input type="checkbox"/> JUN 0025-6 | <input type="checkbox"/> MAY 0036-1 |
| <input type="checkbox"/> OCT 0018-3 | <input type="checkbox"/> JUL 0026-4 | <input type="checkbox"/> JUN 0037-X |
| <input type="checkbox"/> NOV 0019-1 | <input type="checkbox"/> AUG 0027-2 | <input type="checkbox"/> JUL 0038-8 |
| <input type="checkbox"/> DEC 0020-5 | <input type="checkbox"/> SEP 0028-0 | <input type="checkbox"/> AUG 0039-6 |
| | <input type="checkbox"/> OCT 0029-9 | <input type="checkbox"/> SEP 0040-X |
| | <input type="checkbox"/> NOV 0030-2 | |
| | <input type="checkbox"/> DEC 0031-0 | |

UK = £1.75 Europe = £2.25 Overseas = £3.75

TOTAL VALUE £.....

Please answer these questions to help us improve your magazine

- 1) Do you use your micro for?:
 1 SCHOOL 2 BUSINESS 3 HOBBY
- 2) Do you intend to buy any of the following?:
 1 MONITOR 2 DISC DRIVE 3 SECOND PROCESSOR
 4 PRINTER 5 MODEM
- 3) How many software packages do you think you will buy in the next few months?:
 1 0-5 2 6-10 3 10 or more

I enclose a sterling cheque/postal order for a total of £ _____ made payable to **Redwood Publishing**.

Please debit my Visa (Barclaycard) Access (Mastercard) *Overseas orders are now sent Airmail

Credit card number Expiry date

SIGNED

DATE

MR/MRS/MISS/MS

INITIALS

SURNAME

ADDRESS

POSTCODE

TELEPHONE

Please return your order to:— **Acorn User Mail Order, Lambourn Woodlands, Newbury, Berkshire RG16 7TW.**

For Office Use Only

0 0

2 0 0 1 X 0 1 9 N Y D P

B41

YELLOW PAGES

INDEX / COMPATIBILITY

Entering listings

To make the task of entering listings easier, *Acorn User* has adopted several standards in the Yellow Pages. Programs are listed with line numbers in increments of 10, so type AUTO <Return> for automatic line numbering before you start. Before you list what you've entered, type LISTO 1 <Return> to provide spaces after the line numbers. Programs in the Yellow Pages are often listed to a width of 40 characters, so type MODE 6 <Return> before you start. Comparing the line-endings of your listing with the Yellow Pages will help you spot extra or missing characters.

To make sure that the program you want to enter will work on your particular machine, check the index below. All the listings work with Basic 1, 2 and 4 (unless stated otherwise) and with operating system OS1.2 or above. If a program is accompanied by an article, please read the article first. If special care is needed when entering a listing, we provide a 'How to Enter' box.

Once you've typed in your program, save it to tape or disc then test it by running it. If you've made a mistake, an error message will probably appear, telling you which line contains the error. List the line and check it carefully against the published version.

If the line is the start of a procedure definition - eg, 1000 DEF PROCfred - the error may be at another line which calls the procedure. For further help with debugging, refer to First Byte in the April 1986 issue.

A-MAZE-ING

118

An imaginative and addictive 3D maze game by David Lawrence. Read how to play the game on page 88.

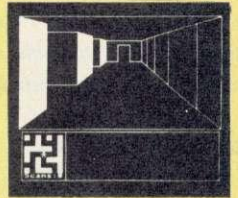

ON THE MENU

115

From a simple ten-liner to a sophisticated program, Joe Telford shows how to create versatile menus on page 81.



CLEVER CALLIGRAPHY

121

Print large-size ornamental lettering on your dot-matrix printer with graphics software by Mike Turner. Article: page 93.

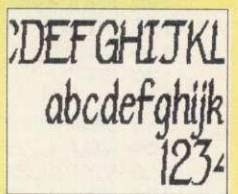

DISCS AND TAPES

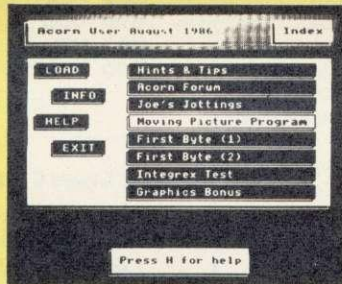

All the listings on these pages can be found on this month's listings disc or cassette. See page 107 for details.

BACK ISSUES



April 86: Programmer's aid utility; June 85: Typing in listings; Aug 84 and Sept 83: Debugging listings.

Program	Page	BBC B	BBC B+/ 128k	BBC with ADFS	Shadow RAM	Electron	Electron with Plus 1	Electron with Plus 1 and Plus 3	Master 128	Master 128 with ADFS	6502SP	Econet	Monthly cassette & disc
Hints & Tips	Listing 1	114	Y	Y	Y	Y	Y	Y	Y	Y	Y	Y	Y
	Listing 2	114	Y	Y	Y	Y	Y	Y	Y	Y	Y	Y	Y
	Listing 3	114	Y	Y	Y	Y	Y	Y	Y	Y	Y	Y	Y
	Listing 4	114	Y	Y	Y	Y	Y	Y	Y	Y	Y	Y	Y
	Listing 5	115	Y	Y	Y	Y	Y	Y	Y	Y	Y	Y	Y(a)
	Listing 6	116	Y	Y	Y	Y	Y	Y	Y	Y	Y	Y	Y(a)
Romfile	Listing 1	117	Y	Y	Y	N	N	N	Y	Y	N	Y	Y(b)
Joe's Jottings	Listings 1-4	120	Y	Y	Y	Y	Y	Y	Y	Y	Y	Y	Y
	Listings 5-6	121	Y	Y	Y	Y	Y	Y	Y	Y	Y	Y	Y
	Listing 8	122	Y	Y	Y	Y	Y	Y	Y	Y	Y	Y	Y
	Listing 9	122	Y	Y	Y	Y	Y	Y	Y	Y	Y	Y	Y
	Listing 10	123	Y	Y	Y	Y	Y	Y	Y	Y	Y	Y	Y
Maze	Listing 1	123	Y	Y	Y	Y	Y	Y	Y	Y	Y	Y	Y
Calligraphy	Listing 1	126	Y	Y	Y	Y	Y	Y	Y	Y	Y	Y	Y
	Listing 2	128	Y	Y	Y	Y	Y	Y	Y	Y	Y	Y	Y

(a) Run with Page set to &B00 if using TUBE.

(b) Needs sideways RAM. Enter and Run with Page set to &1200.

YELLOW PAGES

HINTS & TIPS

How to enter Hints & Tips

The six listings from this month's Hints & Tips are designed for use on any BBC Micro, Electron or Master machine with an Epson-compatible printer. As with all the programs in the yellow pages, we advise that you read carefully the article they accompany. Listings 5 and 6 contain sizeable sections of machine code and so checksum routines have been included to help you spot any typing errors.

See Hints & Tips, page 50

Listing 1. Demonstrates the bit-image graphics on a printer

```
10 REM Hints & Tips - listing 1
20 REM Epson bit image mode
30 REM by Martin Phillips
40 REM for BBC B/B+/M/E with Plus 1
50 REM (c) Acorn User September 1986
60 :
70 VDU 2
80 PRINT"Function key ";
90 PROCsymbol
100 PRINT" is shown here"
110 VDU 3
120 END
130 :
140 DEF PROCsymbol
150 VDU 1,27,1,75,1,11,1,0
160 VDU 1,255,1,247,1,193,1,183
170 VDU 1,223,1,255,1,255,1,221
180 VDU 1,129,1,253,1,255
190 ENDPROC
```

Listing 2. Demonstrates dual density bit-image graphics on an Epson

```
10 REM Hints & Tips - listing 2
20 REM Epson d/d bit image mode
30 REM by Martin Phillips
40 REM for BBC B/B+/M/E with Plus 1
50 REM (c) Acorn User September 1986
60 :
70 VDU 2
80 PRINT"Function key ";
90 PROCsymbol
100 PRINT" is shown here"
110 VDU 3
120 END
130 :
140 DEF PROCsymbol
150 VDU 1,27,1,76,1,22,1,0
160 VDU 1,255,1,255,1,247,1,247
170 VDU 1,193,1,193,1,183,1,183
180 VDU 1,223,1,223,1,255,1,255
190 VDU 1,255,1,255,1,221,1,221
200 VDU 1,129,1,129,1,253,1,253
210 VDU 1,255,1,255
220 ENDPROC
```

Listing 3. A Basic screen dump for modes 1, 2, 4 and 5

```
10 REM Hints & Tips - listing 3
20 REM Modes 1,2,4 & 5 screen dump
30 REM by Martin Phillips
40 REM for BBC B/B+/M/E with Plus 1
```

Continued ►

◀ Listing 3 continued

```
50 REM (c) Acorn User September 1986
60 :
70 MODE 1
80 PROCcircles
90 PROCdump
100 END
110 :
120 DEF PROCcircles
130 VDU 19,0,4,0,0,0
140 VDU 23;8202;0;0;0;
150 VDU 29,640;512;
160 FOR NX=100 TO 500 STEP 80
170 FOR TX=-1 TO 1 STEP 2
180 MOVE -NX,0
190 FOR XX=-NX TO NX STEP 8
200 DRAW XX,TX*(SQR(NX*NX-XX*XX))
210 NEXT XX,TX,NX
220 VDU 29,0;0;
230 ENDPROC
240 :
250 DEF PROCdump
260 VDU 2,1,27,1,64
270 VDU 1,27,1,65,1,8
280 FOR YX=1023 TO 0 STEP -32
290 VDU 1,27,1,75,1,64,1,1
300 FOR XX=0 TO 1279 STEP 4
310 DX=0
320 FOR yX=0 TO 7
330 DX=DX*2
340 IF POINT(XX,YX-yX*4)>0 DX=DX+1
350 NEXT yX:VDU 1,DX
360 NEXT XX
370 VDU 1,10;NEXT YX
380 VDU 1,27,1,64,3
390 ENDPROC
```

Listing 4. A mode 0 Basic screen dump

```
10 REM Hints & Tips - listing 4
20 REM Mode 0 screen dump
30 REM by Martin Phillips
40 REM for BBC B/B+/M/E with Plus 1
50 REM (c) Acorn User September 1986
60 :
70 MODE 0
80 PROCcircles
90 PROCdump
100 END
110 :
120 DEF PROCcircles
130 VDU 19,0,4,0,0,0
140 VDU 23;8202;0;0;0;
150 VDU 29,640;512;
160 FOR NX=100 TO 500 STEP 80
170 FOR TX=-1 TO 1 STEP 2
180 MOVE -NX,0
190 FOR XX=-NX TO NX STEP 8
200 DRAW XX,TX*(SQR(NX*NX-XX*XX))
210 NEXT XX,TX,NX
220 VDU 29,0;0;
230 ENDPROC
240 :
250 DEF PROCdump
260 VDU 2,1,27,1,64
270 VDU 1,27,1,65,1,8
280 FOR YX=1023 TO 0 STEP -32
290 VDU 1,27,1,76,1,128,1,2
300 FOR XX=0 TO 1279 STEP 2
```

Continued ►

YELLOW PAGES

HINTS & TIPS

◀ Listing 4 continued

```
310 DX=0
320 FOR Y%=0 TO 7
330 D%=DX*2
340 IF POINT(X%,Y%-Y%*4)>0 DX=DX+1
350 NEXT Y%:VDU 1,DX
360 NEXT X%
370 VDU 1,10
380 NEXT Y%
390 VDU 1,27,1,64,3
400 ENDPROC
```

Listing 5. A machine code screen dump for modes 1, 2, 4 and 5

```
10 REM Hints & Tips - listing 5
20 REM Modes 1/2/4/5 MC screen dump
30 REM by Martin Phillips
40 REM for BBC B/B+/M/E (with plus1)
50 REM (c) Acorn User September 1986
60 :
70 PROCassemble
80 MODE 1
90 PROCcircles
100 CALL &900
110 END
120 :
130 DEF PROCcircles
140 VDU 19,0,4,0,0,0
150 VDU 23;8202;0;0;0;
160 VDU 29,640;512;
170 FOR NX=100 TO 500 STEP 80
180 FOR TX=-1 TO 1 STEP 2
190 MOVE -NX,0
200 FOR XX=-NX TO NX STEP 8
210 DRAW XX,TX*(SQR(NX*NX-XX*XX))
220 NEXT XX,TX,NX
230 VDU 29,0;0;
240 ENDPROC
250 :
260 DEF PROCassemble
270 xlo=&70;xhi=&71;ylo=&72;yhi=&73
280 pixel=&74;byte=&75;bitcount=&76
290 oswrch=&FFEE;osword=&FFF1
300 FOR pass=0 TO 2 STEP 2
310 PX=&900
320 [OPT pass
330 LDA #2
340 JSR oswrch
350 LDA #255
360 STA ylo
370 LDA #3
380 STA yhi
390 LDA #27
400 JSR printer
410 LDA #65
420 JSR printer
430 LDA #8
440 JSR printer
450 .newline
460 LDA #0
470 STA xlo
480 STA xhi
490 LDA #27
500 JSR printer
510 LDA #75
520 JSR printer
530 LDA #64
540 JSR printer
```

Continued ▶

◀ Continued

```
550 LDA #1
560 JSR printer
570 .newcolumn
580 LDA #8
590 STA bitcount
600 .readpixel
610 LDX #xlo
620 LDY #0
630 LDA #9
640 JSR osword
650 CLC
660 LDA pixel
670 BEQ setbyte
680 SEC
690 .setbyte
700 ROL byte
710 LDA ylo
720 SEC
730 SBC #4
740 STA ylo
750 BCS columnend
760 DEC yhi
770 .columnend
780 DEC bitcount
790 LDA bitcount
800 BNE readpixel
810 LDA byte
820 JSR printer
830 CLC
840 LDA #4
850 ADC xlo
860 STA xlo
870 BCC lineend
880 INC xhi
890 .lineend
900 LDA xhi
910 CMP #5
920 BEQ endline
930 LDA #32
940 CLC
950 ADC ylo
960 STA ylo
970 BCC newcolumn
980 INC yhi
990 BCS newcolumn
1000 .endline
1010 LDA #10
1020 JSR printer
1030 .checkend
1040 LDA yhi
1050 BMI end
1060 JMP newline
1070 .end
1080 LDA #27
1090 JSR printer
1100 LDA #64
1110 JSR printer
1120 LDA #3
1130 JSR oswrch
1140 RTS
1150 .printer
1160 PHA
1170 LDA #1
1180 JSR oswrch
1190 PLA
1200 JSR oswrch
1210 RTS
1220 J: NEXT pass
1230 :
```

Continued ▶

YELLOW PAGES

UTILITIES

◀ Hints & Tips listing 5 continued

```
1240 REM Checksum
1250 total%=0
1260 FOR byte%=&900 TO P%-1
```

```
1270 total%=total%+?byte%
1280 NEXT byte%
1290 IF total%<>17939 PRINT"Checksum error - please check listing":END
1300 ENDPROC
```

Listing 6. A machine code screen dump for mode 0 (NB. WIDTH = 24)

```
10 REM Hints & Tips -
listing 6
20 REM Mode 0 MC screen dump
30 REM by Martin Phillips
40 REM for BBC B/B+/M/E (with plus1)
50 REM (c) Acorn User September 1986
60 :
70 PROCassemble
80 MODE 0
90 PROCcircles
100 CALL &900
110 END
120 :
130 DEF PROCcircles
140 VDU 19,0,4,0,0,0
150 VDU 23;8202;0;0;0;0;
160 VDU 29,640;512;
170 FOR N%=100 TO 500
STEP 80
180 FOR T%=-1 TO 1 STEP 2
190 MOVE -N%,0
200 FOR X%=-N% TO N% STEP 8
210 DRAW X%,T%*(SQR(N%*N%-X%*X%))
220 NEXT X%,T%,N%
230 VDU 29,0;0;
240 ENDPROC
250 :
260 DEF PROCassemble
270 xlo=&70:yhi=&71:yl
o=&72:yhi=&73
280 pixel=&74:byte=&75
:bitcount=&76
290 oswrch=&FFEE:osword=&FFF1
300 FOR pass=0 TO 2 STEP 2
310 P%=&900
320 [OPT pass
330 LDA #2
340 JSR oswrch
350 LDA #255
360 STA ylo
370 LDA #3
380 STA yhi
390 LDA #27
400 JSR printer
410 LDA #65
420 JSR printer
430 LDA #8
440 JSR printer
450 .newline
460 LDA #0
470 STA xlo
480 STA xhi
490 LDA #27
500 JSR printer
510 LDA #76
520 JSR printer
530 LDA #128
540 JSR printer
550 LDA #2
560 JSR printer
570 .newcolumn
580 LDA #8
590 STA bitcount
600 .readpixel
610 LDX #xlo
620 LDY #0
630 LDA #9
640 JSR osword
650 CLC
660 LDA pixel
670 BEQ setbyte
680 SEC
690 .setbyte
700 ROL byte
710 LDA ylo
720 SEC
730 SBC #4
740 STA ylo
750 BCS columnend
760 DEC yhi
770 .columnend
780 DEC bitcount
790 LDA bitcount
800 BNE readpixel
810 LDA byte
820 JSR printer
830 CLC
840 LDA #2
850 ADC xlo
860 STA xlo
870 BCC lineend
880 INC xhi
890 .lineend
900 LDA xhi
910 CMP #5
920 BEQ endline
930 LDA #32
940 CLC
950 ADC ylo
960 STA ylo
970 BCC newcolumn
980 INC yhi
990 BCS newcolumn
1000 .endline
1010 LDA #10
1020 JSR printer
1030 .checkend
1040 LDA yhi
1050 BMI end
1060 JMP newline
1070 .end
1080 LDA #27
1090 JSR printer
1100 LDA #64
1110 JSR printer
1120 LDA #3
1130 JSR oswrch
1140 RTS
1150 .printer
1160 PHA
1170 LDA #1
1180 JSR oswrch
1190 PLA
1200 JSR oswrch
1210 RTS
1220 ]:NEXT pass
1230 :
1240 REM Checksum
1250 total%=0
1260 FOR byte%=&900 TO P%-1
1270 total%=total%+?byte%
1280 NEXT byte%
1290 IF total%<>18003 PRINT"Checksum error - please check listing":END
1300 ENDPROC
```

How to enter Romfile

Type in the main program as shown. The listing includes a fair chunk of assembly code and the program contains its own checking routines. If a typing error has been entered you will be notified when the program is run. A message displaying the section of program at fault is also given. All users (except tape users - see below) should type in the program with PAGE set to &1200. This is done by typing:

```
PAGE = &1200 <RETURN>
NEW <RETURN>
```

and then copying out the listing.

Tape Users

If you plan to use the Romfile system on a tape-based machine, several adjustments need to be made to the program. Notes on doing this, with a list of the lines that need to be amended, are given in the article on page 104.

Electron users with Sideways RAM

The program as it stands will not operate correctly on an Electron, however, a version specifically for this machine has been supplied on the monthly cassette on side 2.

YELLOW PAGES

UTILITIES

See File It Sideways, page 102

Listing 1. Scrambles a set of files into ROM Filing System format

```

10 REM Romfile
20 REM Mike Rawlings
30 REM for BBC B/B+/M
with s/w Ram
40 REM (c) Acorn User
September 1986
50 :
60 MODE 7
70 IF PAGE>1200 THEN
PROCreloc
80 LOMEM=&7400
90 DIM control% 17, name% 80
100 osfile=&FFDD
110 p%=&8000-&3400
120 PRINT
130 FOR x=0 TO 1
140 PRINTCHR$(141)SPC(10);
150 PRINT"Acorn User Romfile"
160 NEXT
170 VDU 28,0,23,39,4
180 REPEAT:INPUT"Ram socket:"bk:UNTILbk>=0 AND bk<16
190 PROCass:C%=0
200 FOR x=crc TO(read-1):C%=C%+?x
210 NEXT:IF C%>5782 PROCerr("CRC")
220 !&8B=&70: ?&8F=check-&70:CALL crc
230 x=!&8D AND &FFFF
240 IF x<>26070 PROCerr("INPUT")
250 !&8B=read: ?&8F=P%-read:CALL crc
260 x=!&8D AND &FFFF
270 REPEATREADs,v:UNTILs=bk
280 IFv<>x THEN PROCerr("READ/WRITE")
290 PRINTTAB(0,8)CHR$(134);
300 PRINT"Romfile Title ?"CHR$(133);
310 title$=FNinput(7)
320 PRINTTAB(0,10)CHR$(134);
330 PRINT"8k or 16k Ram?"CHR$(133);
340 REPEAT x=GET
350 UNTIL x=56 OR x=49
360 VDU x
370 IF x=56 rom=&2000:GOTO 420
380 REPEAT x=GET
390 UNTIL x=54
400 VDU x
410 rom=0
420 REPEAT x=GET
430 UNTIL x=13
440 PROCromsetup
450 IF title$="TEST123" PROCcheck
460 PROCmemleft
470 IF memleft<1 PRINT "No memory left!":GOTO 610
480 *FX 15
490 PRINTTAB(0,8)CHR$(134);
500 PRINT"Filename ?"CHR$(133);
510 file$=FNinput(7)
520 PROCoscli("LOAD "+file$+" 3400")
530 PROCrdaddr
540 x=length DIV 256
550 x=x-((length MOD 256)<>0)
560 search=P%+length+(23+LEN(file$))*(1-(x>1))-(x-2)*3*(x>1)
570 IF length>memleftGOTO 730
580 PROCencode
590 PROCmore
600 IF x=89 VDU 28,0,23,39,4:GOTO 460
610 PRINT'CHR$(130);
620 PRINT"Press SPACE to save"
630 REPEAT:UNTIL GET=32
640 PROCequb(43)
650 PROCsave
660 VDU 7
670 PROCmore
680 IF x=89 CLS:GOTO 290
690 *FX 18
700 PRINT'"Press Break"'
710 END
720 :
730 IF length>&3400GOTO 780
740 PRINTTAB(0,8)CHR$(129);
750 PRINT"This file is too long!"
760 GOTO 590
770 :
780 CLS
790 PRINTTAB(0,9)CHR$(129);
800 PRINT"This file is far too long!"
810 PRINTCHR$(129)"You will have to ";
820 PRINT"start again"
830 x=GET
840 RUN
850 :
860 DEF PROCromsetup
870 FOR pass=0 TO 2 STOP 2
880 P%=&3400
890 PROCequb(0)
900 PROCequb(0)
910 [OPT pass
920 JMP entry+p%
930 ]
940 PROCequb(&83)
950 PROCequb(LEN(title$)+9)
960 PROCequb(1)
970 PROCequb(title$)
980 PROCequb(0)
990 PROCequb("(C) Acorn User / ")
1000 PROCequb(0)
1010 [OPT pass
1020 .entry
1030 CMP #3
1040 BEQ v4
1050 CMP #9
1060 BEQ v1
1070 CMP #13
1080 BEQ v2
1090 CMP #14
1100 BEQ v3
1110 RTS
1120 .v1
1130 JMP help1+p%
1140 .v2
1150 JMP file+p%
1160 .v3
1170 JMP byte+p%
1180 .v4
1190 JMP boot+p%
1200 .help1
1210 PHA
1220 LDA (&F2),Y
1230 CMP #13
1240 BNE help2
1250 LDX #0
1260 .loop1
1270 LDA message1+p%,X
1280 INX
1290 CMP #0
1300 BEQ exit1
1310 JSR &FFE3
1320 JMP loop1+p%
1330 .exit1
1340 PLA
1350 RTS
1360 .message1
1370 ]
1380 PROCequb(13)
1390 PROCequb("Acorn User Romfile")
1400 PROCequb(13)
1410 PROCequb("Type *HELP ROMFILE")
1420 PROCequb(13)
1430 PROCequb(13)
1440 PROCequb(0)
1450 [OPT pass
1460 .help2
1470 TYA
1480 PHA
1490 LDX #0
1500 .loop2
1510 LDA (&F2),Y
1520 AND #&DF
1530 CMP #&21
1540 BCC skip1
1550 CMP romfile+p%,X
1560 BNE exit2
1570 INX
1580 INY
1590 JMP loop2+p%
1600 .skip1
1610 LDA romfile+p%,X

```

Continued ▶

YELLOW PAGES

UTILITIES

◀ Rawlings' listing 1 continued

```

1620 BNE exit2
1630 JMP help3+p%
1640 .exit2
1650 PLA
1660 TAY
1670 PLA
1680 RTS
1690 .romfile
1700 ]
1710 PROCequs("ROMFILE"
)
1720 PROCequeb(0)
1730 [OPT pass
1740 .help3
1750 LDX #0
1760 .loop3
1770 LDA message2+p%,X
1780 INX
1790 CMP #0
1800 BEQ exit2
1810 JSR &FFE3
1820 JMP loop3+p%
1830 .message2
1840 ]
1850 PROCequeb(13)
1860 PROCequs(" To loa
d any program ")
1870 PROCequs("from Aco
rn User's")
1880 PROCequeb(13)
1890 PROCequs("ROMFILE
type *ROM ")
1900 PROCequs("followed
by <return>")
1910 PROCequeb(13)
1920 PROCequs("then LOA
D, CHAIN, ")
1930 PROCequs("*LOAD, *
RUN, *CAT")
1940 PROCequeb(13)
1950 PROCequs("etc. in
the normal way")
1960 PROCequeb(13)
1970 PROCequeb(0)
1980 [OPT pass
1990 .file
2000 PHA
2010 TYA
2020 EOR #&F
2030 CMP &F4
2040 BCC exit3
2050 LDA #((data+p%) MD
D 256)
2060 STA &F6
2070 LDA #((data+p%) DI
V 256)
2080 STA &F7
2090 LDA &F4
2100 EOR #&F
2110 STA &F5
2120 PLA
2130 LDA #0
2140 RTS
2150 .exit3
2160 PLA
2170 RTS
2180 .byte
2190 PHA
2200 LDA &F5
2210 EOR #&F
2220 CMP &F4
2230 BNE exit3
2240 LDY #0
2250 LDA (&F6),Y
2260 TAY
2270 INC &F6
2280 BNE skip2
2290 INC &F7
2300 .skip2
2310 PLA
2320 LDA #0
2330 RTS
2340 .boot
2350 PHA
2360 TYA
2370 PHA
2380 LDY #0
2390 .loop4
2400 LDA message3+p%,Y
2410 BEQ exit4
2420 JSR &FFE3
2430 INY
2440 JMP loop4+p%
2450 .message3
2460 ]
2470 PROCequs("Romfile:
2480 PROCequeb(134)
2490 PROCequs(title$)
2500 PROCequeb(13)
2510 PROCequeb(13)
2520 PROCequeb(0)
2530 [OPT pass
2540 .exit4
2550 PLA
2560 TAY
2570 PLA
2580 RTS
2590 .data
2600 JNEXT
2610 ?&BF=((data-&3400)
/256)+1
2620 !&BB=&3400B000
2630 ?&B9=0
2640 CALL write
2650 P%=P%+p%
2660 ENDPROC
2670 :
2680 DEF PROCass
2690 P%=&70
2700 [OPT 0
2710 .input
2720 CLC
2730 LDA #0
2740 TAX
2750 STX &BB
2760 LDX #&C
2770 STX &BC
2780 LDX #32
2790 STX &BE
2800 LDX #127
2810 STX &BF
2820 TAY
2830 LDX #&BB
2840 JSR &FFF1
2850 RTS
2860 .check
2870 ]
2880 :
2890 FOR pass=0 TO 2 ST
EP 2
2900 P%=&900
2910 [OPT pass
2920 .crc
2930 CLC
2940 LDA #0
2950 STA &BE
2960 STA &BD
2970 TAY
2980 .loop1
2990 LDA &BE
3000 EOR (&BB),Y
3010 STA &BE
3020 LDX #8
3030 .loop2
3040 LDA &BE
3050 ROL A
3060 BCC skip
3070 LDA &BE
3080 EOR #8
3090 STA &BE
3100 LDA &BD
3110 EOR #16
3120 STA &BD
3130 .skip
3140 ROL &BD
3150 ROL &BE
3160 DEX
3170 BNE loop2
3180 INY
3190 CPY &BF
3200 BNE loop1
3210 RTS
3220 .read
3230 LDA #&80
3240 STA &BE
3250 LDA #&34
3260 STA &BC
3270 LDY #0
3280 STY &BD
3290 STY &BB
3300 STY &B9
3310 .write
3320 LDY #0
3330 LDA #&F4
3340 PHA
3350 LDA #bk
3360 STA &FE30
3370 LDX &BF3
3380 .loop3
3390 LDA (&BD),Y
3400 STA (&BB),Y
3410 INY
3420 CPY &B9
3430 BNE loop3
3440 INC &BC
3450 INC &BE
3460 DEX
3470 BNE loop3
3480 PLA
3490 STA &FE30
3500 RTS
3510 JNEXT
3520 ENDPROC
3530 :
3540 DEF FNinput(x)
3550 PRINTSTRING$(x,CHR
$(?) )CHR$(124);
3560 PRINTSTRING$(x+1,C
HR$(B));
3570 ?&BD=x
3580 CALL &70

```

Continued ▶

YELLOW PAGES UTILITIES

◀ Rawlings' listing 1 continued

```

3590 =%&C00
3600 :
3610 DEF PROCmemleft
3620 x=%&C000-P%-rom-30
3630 IF x<257 memleft=x
ELSE x=x-30:IF x<513 me
mleft=x ELSE memleft=x-(
(x-512) DIV 259)*3+(((x-
512) MOD 259)<>0)*3
3640 CLS
3650 PRINT'SPC(6)CHR$(1
31);
3660 PRINT"MAXIMUM FILE
LENGTH = ";
3670 PRINT;~memleft
3680 VDU 28,0,23,39,8
3690 ENDPROC
3700 :
3710 DEF PROCencode
3720 @%=6
3730 block=0:address=%3
400
3740 flag=0:blen=256
3750 IF length<257 blen
=length:flag=%80
3760 PROCheader
3770 PRINTTAB(0,10)CHR$(
131);
3780 PRINTfile$ ~block
3790 ?&89=blen:?&8F=1:
&8B=P%
3800 ?&8D=address MOD 2
56
3810 ?&8E=address DIV 2
56
3820 CALL write
3830 !&8B=address:?&8F=
blen
3840 CALL crc
3850 hcrc=?&8E:lcrc=?&8
D
3860 P%=P%+blen
3870 address=address+bl
en
3880 length=length-blen
3890 block=block+1
3900 PROCequb(hcrc)
3910 PROCequb(lcrc)
3920 IF flag=%80 @%=5:P
RINTTAB(14,10)~!&2F8:VDU
7:ENDPROC
3930 IF length<257 GOTO
3750
3940 PROCequb(35)
3950 GOTO 3770
3960 :
3970 DEF PROCChblock
3980 PROCequb(42)
3990 PROCequs(file$)
4000 PROCequb(0)
4010 PROCequd(load)
4020 PROCequd(exec)
4030 PROCequw(block)
4040 PROCequw(blen)
4050 PROCequb(flag)
4060 PROCequd(search)
4070 ENDPROC
4080 :
4090 DEF PROCheader
4100 x=P%:P%=%980
4110 PROCChblock
4120 !&8B=%981:?&8F=P%-
&981
4130 CALL crc
4140 hcrc=?&8E:lcrc=?&8
D:P%=x
4150 PROCChblock
4160 PROCequb(hcrc)
4170 PROCequb(lcrc)
4180 ENDPROC
4190 :
4200 DEF PROCsave
4210 ?&8F=((P%-%8000)/2
56)+1
4220 CALL read
4230 VDU 28,0,23,39,4
4240 CLS
4250 PRINTTAB(0,8)CHR$(
134);
4260 PRINT"Saving ";tit
le$
4270 PROCoscli("SAVE "+
title$+" 3400 "+"STR$(P
%-%8000)+" FFFFD9CD FFFF
8000")
4280 x=TIME+300:REPEAT:
UNTIL x<TIME
4290 ENDPROC
4300 :
4310 DEF PROCequb(n)
4320 PROCsetequ
4330 ?&89=1:?&9F0=n
4340 CALL write
4350 P%=P%+1
4360 ENDPROC
4370 :
4380 DEF PROCequw(n)
4390 PROCsetequ
4400 ?&89=2:~!&9F0=n
4410 CALL write
4420 P%=P%+2
4430 ENDPROC
4440 :
4450 DEF PROCequd(n)
4460 PROCsetequ
4470 ?&89=4:~!&9F0=n
4480 CALL write
4490 P%=P%+4
4500 ENDPROC
4510 :
4520 DEF PROCequs(n$)
4530 PROCsetequ
4540 ?&89=LEN(n$):%&9F0
=n$
4550 CALL write
4560 P%=P%+LEN(n$)
4570 ENDPROC
4580 :
4590 DEF PROCoscli(n$)
4600 %&980=n%:Y%=%9: X%=%
&80
4610 CALL &FFFF7
4620 ENDPROC
4630 :
4640 DEF PROCmore
4650 PRINTTAB(0,12)CHR$(
134);
4660 PRINT"Any More ?"C
HR$(133);
4670 REPEAT x=GET
4680 x=(x OR &20)-32
4690 UNTIL x=%89 OR x=78
4700 VDU x
4710 ENDPROC
4720 :
4730 DEF PROCsetequ
4740 ?&8F=1:~!&8B=P%:?&8
D=%F0:?&8E=%9
4750 ENDPROC
4760 :
4770 DEF PROCerr(n$)
4780 CLS
4790 PRINT'"There is an
error in the ";
4800 PRINTn$'"routine,
";
4810 PRINT"please check
again!";
4820 END
4830 :
4840 DEF PROCcheck
4850 !&8B=%3400:?&8F=me
ssage2-%3400
4860 CALL crc
4870 x=!&8D AND &FFFF
4880 IF x<>42307 PROCer
r("SETUP")
4890 !&8B=message2:?&8F
=P%-message2
4900 CALL crc
4910 x=!&8D AND &FFFF
4920 IF x<>1569 PROCerr
("SETUP")
4930 CLS:PRINT'"Code is
correct"
4940 END
4950 :
4960 DEF PROCrdaddr
4970 !control%=name$
4980 $name%=file$
4990 X%=control%
5000 Y%=control% DIV 25
6
5010 AX=5:CALL osfile
5020 length=control%!10
5030 load=control%!2
5040 exec=control%!6
5050 ENDPROC
5060 :
5070 DEF PROCreloc
5080 PRINT"Relocating .
.. Please wait"
5090 FOR X%=0 TO TOP-PA
GE STEP 4
5100 X%!&1200=X%!PAGE
5110 NEXT
5120 PAGE=%&1200
5130 *KEY 0 OLD:MRUN:IM
5140 *FX 138,0,128
5150 END
5160 :
5170 DATA 0,2644,1,7986
,2,8344,3,13822
5180 DATA 4,24524,5,191
14,6,29952,7,24678
5190 DATA 8,41316,9,460
82,10,35752,11,40654
5200 DATA 12,62716,13,5
7754,14,56880,15,52054

```

YELLOW PAGES

JOE'S JOTTINGS

See On the Menu, page 81

How to enter Joe's Jottings

PROCdouble in listing 5 (starting at line 330) should be added to listings 6-8 as well. Type in PROCdouble separately starting at line 2000, and then spool it to a file on disc or tape, by typing in:

*SPOOL double <RETURN>

LIST 2000, <RETURN>

*SPOOL <RETURN>

Then to add PROCdouble to listing 6, load this in and type:

*EXEC double <RETURN>

Now save the complete program. Repeat for listings 7 and 8.

The four sound procedures given in listing 10 should be added to each of listings 1 to 9 using the technique outlined above.

Listing 1. A simple menu

```
10 REM Joe's Jottings
- listing 1
20 REM Simple menu, 1
30 REM by Joe Telford
40 REM BBC B/B+/M/E
50 REM (c) Acorn User
September 1986
```

```
60 :
70 MODE 4
80 REPEAT
90 PRINT "1.....Siren
1"
100 PRINT "2.....Siren
2"
110 PRINT "3.....Siren
3"
```

```
120 INPUT "Which? "cho
ice
130 IF choice=1 PROCsi
ren1
140 IF choice=2 PROCsi
ren2
150 IF choice=3 PROCsi
ren3
160 UNTIL FALSE
```

Listing 2. An upgraded version of listing 1

```
10 REM Joe's Jottings
- listing 2
20 REM A simple menu
(2)
30 REM by Joe Telford
40 REM for BBC B/B+/M
/E
50 REM (c) Acorn User
September 1986
60 :
```

```
70 MODE 4
80 REPEAT
90 REPEAT
100 PRINT "1.....END"
110 PRINT "2.....RE-RU
N"
120 PRINT "3.....Siren
1"
130 PRINT "4.....Siren
2"
140 PRINT "5.....Siren
3"
150 INPUT "Which? "cho
```

```
ice
160 UNTIL choice>0 AND
choice<6
170 IF choice=1 PRINT '
"Ended!":END
180 IF choice=2 RUN
190 IF choice=3 PROCsi
ren1
200 IF choice=4 PROCsi
ren2
210 IF choice=5 PROCsi
ren3
220 UNTIL FALSE
```

Listing 3. Menu with a procedure

```
10 REM Joe's Jottings
- listing 3
20 REM Proceduralised
menu
30 REM by Joe Telford
40 REM for BBC B/B+/M
/E
50 REM (c) Acorn User
September 1986
60 :
70 MODE 4
```

```
80 REPEAT
90 PROCmenu
100 IF choice=1 PRINT '
"Ended!":END
110 IF choice=2 RUN
120 IF choice=3 PROCsi
ren1
130 IF choice=4 PROCsi
ren2
140 IF choice=5 PROCsi
ren3
150 UNTIL FALSE
160 :
170 DEF PROCmenu
```

```
180 REPEAT
190 PRINT "1.....END"
200 PRINT "2.....RE-RU
N"
210 PRINT "3.....Siren
1"
220 PRINT "4.....Siren
2"
230 PRINT "5.....Siren
3"
240 INPUT "Which? "cho
ice
250 UNTIL choice>0 AND
choice<6
260 ENDPROC
```

Listing 4. A function menu

```
10 REM Joe's Jottings
- listing 4
20 REM Function menu
30 REM by Joe Telford
40 REM for BBC B/B+/M
/E
50 REM (c) Acorn User
September 1986
60 :
70 MODE 4
80 REPEAT
90 choice=FNmenu
```

```
100 IF choice=1 PRINT '
"Ended!":END
110 IF choice=2 RUN
120 IF choice=3 PROCsi
ren1
130 IF choice=4 PROCsi
ren2
140 IF choice=5 PROCsi
ren3
150 UNTIL FALSE
160 :
170 DEF FNmenu
180 LOCAL choice
190 PRINT "1.....END"
200 PRINT "2.....RE-RU
N"
```

```
210 PRINT "3.....Siren
1"
220 PRINT "4.....Siren
2"
230 PRINT "5.....Siren
3"
240 REPEAT
250 INPUT "Which? "cho
ice
260 IF choice<1 OR cho
ice>5 PRINT "Range of cho
ices must be 1.2.3.4.5"
270 UNTIL choice>0 AND
choice<6
280 =choice
```

YELLOW PAGES

JOE'S JOTTINGS

Listing 5. An improved function menu incorporating double-height text

```

10 REM Joe's Jottings
- listing 5
20 REM Improved function menu
30 REM by Joe Telford
40 REM for BBC B/B+/M
/E
50 REM (c) Acorn User
September 1986
60 :
70 MODE 4
80 REPEAT
90 choice=FNmenu(1,5)
100 IF choice=1 PRINT'
"Ended!":END
110 IF choice=2 RUN
120 IF choice=3 PROCsiren1
130 IF choice=4 PROCsiren2
140 IF choice=5 PROCsiren3
150 UNTIL FALSE
160 :

170 DEF FNmenu(min,max)
)
180 LOCAL ch
190 PROCdouble(128,0,"
Sound Effects Menu")
200 PRINTTAB(4,3);"Please
choose an option from
";min;" to ";max
210 PRINTTAB(14,5);"1.
....END"
220 PRINTTAB(14,7);"2.
....RE-RUN"
230 PRINTTAB(14,9);"3.
....Siren1"
240 PRINTTAB(14,11);"4
.....Siren2"
250 PRINTTAB(14,13);"5
.....Siren3"
260 REPEAT
270 PRINTTAB(4,15)"Which?"+STRING$(20," ")
280 INPUTTAB(14,15)"ch"
290 IF ch<min OR ch>max
PRINTTAB(4,17);ch" is
out of the range: ";min"
to ";max

300 UNTILch>=min AND ch<=max
310 =ch
320 :
330 DEF PROCdouble(x,y,z$)
340 LOCAL c%
350 c%=&70
360 IF x>80 THEN PRINT
TAB(20-LENz$ DIV 2,y);ELSE
PRINTTAB(x,y);
370 FOR loop%=1 TO LEN(z$)
380 ?c%=ASC(MID$(z$,loop%,1))
390 X%=c% MOD 256
400 Y%=c% DIV 256
410 A%=10
420 CALL &FFF1
430 VDU 23,128,c%?1,c%?1,c%?2,c%?2,c%?3,c%?3,c%?4,c%?4,128,10,8,23,128,c%?5,c%?5,c%?6,c%?6,c%?7,c%?7,c%?8,c%?8,128,11
440 NEXT
450 ENDPROC

```

Listing 6. A moving pointer menu (don't forget to add the double-height procedures)

```

10 REM Joe's Jottings
- listing 6
20 REM Moving pointer menu
30 REM by Joe Telford
40 REM for BBC B/B+/M
/E
50 REM (c) Acorn User
September 1986
60 :
70 ON ERROR *FX 4,0
80 MODE 4
90 REPEAT
100 choice=FNmenu(1,5)
110 IF choice=1 PRINT'
"Ended!":VDU23,1,3;0;0;0;0;:END
120 IF choice=2 RUN
130 IF choice=3 PROCsiren1
140 IF choice=4 PROCsiren2
150 IF choice=5 PROCsiren3
160 UNTIL FALSE
170 :
180 DEF FNmenu(min,max)
)
190 VDU 23,1,0;0;0;0;0;
200 LOCAL menuptr
210 PROCdouble(128,0,"
Sound Effects Menu")
220 PRINTTAB(14,5);"1.
....END"
230 PRINTTAB(14,7);"2.
....RE-RUN"
240 PRINTTAB(14,9);"3.
....Siren1"
250 PRINTTAB(14,11);"4
.....Siren2"
260 PRINTTAB(14,13);"5
.....Siren3"
270 PRINTTAB(4,15)"Use
Cursor ^ and v to move
arrow"
280 PRINTTAB(4,16)"
Press RETURN to select
"
290 *FX 4,1
300 menuptr=1
310 REPEAT
320 PRINTTAB(11,menuptr
r*2+3);"->";
330 key=GET
340 PRINTTAB(11,menuptr
r*2+3);" ";
350 IF key=139 menuptr
=menuptr-1:IF menuptr=mi
n-1 menuptr=max
360 IF key=138 menuptr
=menuptr+1:IF menuptr=ma
x+1 menuptr=min
370 UNTIL key=13
380 *FX 4,0
390 =menuptr

```

Listing 7. A moving bar menu (don't forget to add the double-height procedures)

```

10 REM Joe's Jottings
- listing 7
20 REM Moving bar menu
30 REM by Joe Telford
40 REM for BBC B/B+/M
/E
50 REM (c) Acorn User
September 1986
60 :
70 DIM menu$(5)
80 ON ERROR *FX 4,0

90 MODE 4
100 REPEAT
110 choice=FNmenu(1,5)
120 IF choice=1 PRINT'
"Ended!":VDU23,1,3;0;0;0;0;:END
130 IF choice=2 RUN
140 IF choice=3 PROCsiren1
150 IF choice=4 PROCsiren2
160 IF choice=5 PROCsiren3
170 UNTIL FALSE

180 :
190 DEF FNmenu(min,max)
)
200 menu$(1)=" END
"
210 menu$(2)=" RE-RUN
"
220 menu$(3)=" Siren 1
"
230 menu$(4)=" siren 2
"
240 menu$(5)=" Siren 3
"

```

Continued ▶

YELLOW PAGES

JOE'S JOTTINGS

◀ Joe's listing 7 continued

```

250 VDU 23,1,0;0;0;0;
260 LOCAL menuptr,loop
%
270 *FX 4,1
280 menuptr=1
290 PROCdouble(128,0,"
Sound Effects Menu")
300 REPEAT
310 FOR loop%=min TO m

```

```

ax
320 IF loop%=menuptr C
OLOURO:COLOUR129 ELSE CO
LOUR1:COLOUR 128
330 PRINTTAB(16,3+loop
%*2);menu$(loop%)
340 NEXT
350 COLOUR 1:COLOUR 12
8
360 PRINT'TAB(5)"Use C
ursor ^ and v to move ba
r"

```

```

370 PRINTTAB(5)" Pr
ess RETURN to select"
380 key=GET
390 IF key=139 menuptr
=menuptr-1:IF menuptr=mi
n-1 menuptr=max
400 IF key=138 menuptr
=menuptr+1:IF menuptr=ma
x+1 menuptr=min
410 UNTIL key=13
420 *FX 4,0
430 =menuptr

```

Listing 8. Moving bars with explanations

```

10 REM Joe's Jottings
- listing 8
20 REM Moving bars wi
th explanations
30 REM by Joe Telford
40 REM for BBC B/B+/M
/E
50 REM (c) Acorn User
September 1986
60 :
70 DIM menu$(5)
80 ON ERROR *FX4,0
90 MODE 4
100 VDU 19,0,4,0;0;0;
110 VDU 19,1,3,0;0;0;
120 REPEAT
130 choice=FNmenu(1,5)
140 IF choice=1 PRINT'
"Ended!":VDU23,1,3;0;0;0
;:END
150 IF choice=2 RUN
160 IF choice=3 PROCsi
ren1
170 IF choice=4 PROCsi
ren2
180 IF choice=5 PROCsi
ren3
190 UNTIL FALSE
200 :
210 DEF FNmenu(min,max
)
220 menu$(1)=" END
"
230 menu$(2)=" RE-RUN
"

```

```

240 menu$(3)=" Siren 1
"
250 menu$(4)=" siren 2
"
260 menu$(5)=" Siren 3
"
270 VDU 23,1,0;0;0;0;
280 LOCAL menuptr,loop
%
290 *FX 4,1
300 menuptr=1
310 PROCdouble(128,18,
"Explanation:")
320 PROCdouble(128,1,"
Sound Effects Menu")
330 REPEAT
340 FOR loop%=min TO m
ING$(len-LEN(m$(loop%)),
" ");
350 NEXT
360 COLOUR 1:COLOUR 12
8
370 key=GET
380 IF key=139 menuptr
=menuptr-1:IF menuptr=0:
menuptr=max
390 IF key=138 menuptr
=menuptr+1:IF menuptr=ma
x+1 menuptr=1
400 UNTIL key=13
410 *FX4,0
420 PROCclosewindow(15
,8,len,max+1)
430 =menuptr
440 :

```

```

450 DEF PROCclosewindo
w(x,y,len,ht)
460 VDU 26
470 GCOL 0,0
480 PROCopenwindow(x,y
,len,ht)
490 CLS
500 VDU 26
510 GCOL 0,1
520 ENDPROC
530 :
540 DEF PROCopenwindow
(x,y,len,ht)
550 VDU 28,x,y+ht,x+le
n-1,y
560 PROCrect(x*32-8,10
16-(y+ht)*32,len*32+12,h
t*32+12,0)
570 PROCrect(x*32,1008
-(y+ht)*32,len*32+16,8,1
)
580 PROCrect((x+len)*3
2+8,1008-(y+ht)*32,8,ht*
32+8,1)
590 ENDPROC
600 :
610 DEF PROCrect(x,y,l
,w,f)
620 MOVE x,y
630 DRAW x+1,y
640 IF f=0 DRAW x+1,y+
w ELSE PLOT 85,x,y+w
650 IF f=0 DRAW x,y+w
ELSE PLOT 85,x+1,y+w
660 MOVE x,y+w
670 IF f=0 DRAW x,y EL
SE MOVE x,y
680 ENDPROC

```

Listing 9. A window menu

```

10 REM Joe's Jottings
- listing 9
20 REM Window menu
30 REM by Joe Telford
40 REM for BBC B/B+/M
/E
50 REM (c) Acorn User
September 1986
60 :
70 DIM m$(10)
80 ON ERROR *FX 4,0
90 MODE 4

```

```

100 VDU 19,0,4,0;0;0;
110 VDU 19,1,3,0;0;0;
120 REPEAT
130 choice=FNwmenu("So
und Effects",5,"END","RE
-RUN","Siren 1","Siren 2
","Siren 3","","","","")
140 IF choice=1 PRINT'
"Ended!":VDU23,1,3;0;0;0
;:END
150 IF choice=2 RUN
160 IF choice=3 PROCsi
ren1

```

```

170 IF choice=4 PROCsi
ren2
180 IF choice=5 PROCsi
ren3
190 UNTIL FALSE
200 :
210 DEF FNwmenu(m$(0),
max,m$(1),m$(2),m$(3),m$
(4),m$(5),m$(6),m$(7),m$
(8),m$(9),m$(10))
220 LOCAL loop%,menupt
r,len:len=0
230 FOR loop%=0 TO 10

```

▶ Continued

YELLOW PAGES

GAMES

◀ Joe's listing 9 continued

```

240 IF LEN(m$(loop%)) >
len THEN len=LEN(m$(loop
%))
250 NEXT
260 VDU 23,1,0;0;0;0;
270 *FX 4,1
280 PROCopenwindow(15,
B,len,max+1)
290 menuptr=1
300 REPEAT
310 PRINTTAB(0,0);
320 FOR loop%=0 TO max
330 IF loop%=menuptr O
R loop%=0 COLOUR 0:COLOU
R 129 ELSE COLOUR 1:COLOU
R 128
340 PRINTm$(loop%);STR
ax
350 IF loop%=menuptr P
ROCexplain(menuptr):COLO
UR 0:COLOUR 129 ELSE COL
OUR 1:COLOUR 128
360 PRINTTAB(16,3+loop
%*2);menu$(loop%)

```

```

370 NEXT
380 COLOUR 1:COLOUR 12
B
390 PRINT'TAB(5)"Use C
ursor ^ and v to move ba
r"
400 PRINTTAB(5)" Pr
ess RETURN to select"
410 key=GET
420 IF key=139 menuptr
=menuptr-1:IF menuptr=mi
n-1 menuptr=max
430 IF key=138 menuptr
=menuptr+1:IF menuptr=ma
x+1 menuptr=min
440 UNTIL key=13
450 *FX 4,0
460 =menuptr
470 :
480 DEF PROCexplain(m)
490 PRINTTAB(0,21);STR
ING$(240," ")
500 PRINTTAB(0,21);
510 IF m=1 PRINT"Press
RETURN now to END this
program."

```

```

520 IF m=2 PRINT"Press
RETURN now to start thi
s program""from the beg
inning."
530 IF m=3 PRINT"Press
RETURN now to hear the
first""type of siren. T
his uses:"" ENVELOPE 1,
0,2,-2,2,6,12,6,127,0,0,
-127,126,0"
540 IF m=4 PRINT"Press
RETURN now to hear the
second""type of siren.
This uses:""FOR cycle=1
TO 10:SOUND1,-15,128,6"
":SOUND1,-15,110,6:NEXT
cycle"
550 IF m=5 PRINT"Press
RETURN now to hear the
third""type of siren. T
his uses:""ENVELOPE 1,3
,1,1,-2,10,10,0,127,0,0,
-127,126,0""Pst....Ever
heard of Star Trek?"
560 ENDPROC

```

Listing 10. Four sound off procedures

```

1000 REM Joe's Jottings
- listing 10
1010 REM Four sound eff
ects procedures
1020 REM by Joe Telford
1030 REM for BBC B/B+/M
/E
1040 REM (c) Acorn User
September 1986
1050 :
1060 DEF PROCsiren1
1070 ENVELOPE 1,0,2,-2,
2,6,12,6,127,0,0,-127,12
6,0

```

```

1080 SOUND 1,1,128,60
1090 ENDPROC
1100 :
1110 DEF PROCsiren2
1120 FOR cycle=1 TO 10
1130 SOUND 1,-15,128,6
1140 SOUND 1,-15,110,6
1150 NEXTcycle
1160 ENDPROC
1170 :
1180 DEF PROCsiren3
1190 ENVELOPE 1,3,1,1,-
2,10,10,0,127,0,0,-127,1
26,0

```

```

1200 SOUND 1,1,128,60
1210 ENDPROC
1220 :
1230 DEF PROCphone
1240 ENVELOPE 1,0,1,1,1
,1,1,1,127,0,0,-127,126,
0
1250 FOR cycle=1 TO 3
1260 SOUND 1,1,128,10
1270 SOUND 1,0,128,6
1280 SOUND 1,1,128,14
1290 SOUND 1,0,128,20
1300 NEXT cycle
1310 ENDPROC

```

Listings on cassette and disc

If you think that keying-in all these listings will get you down and your fingers in a tangle, why not save your time and energy by sending off for our monthly listings cassette or disc? Our monthly cassette holds all the programs featured in the yellow pages. The monthly listings disc also includes a graphics bonus.

The cassette tape for the BBC micro or Electron cost just £3.95, a disc for the BBC is priced at £5.95. (For more information see page 107.)

It is possible to subscribe to the Acorn User monthly listings cassette (£45 for UK subscribers, see order form page 111). If you do so now we will send you our two special cassettes, worth £3.95 each (see page 107 for details).

The two cassettes are the entertaining and ever-popular graphics cassette and the comprehensive selection of 11 programs contained in the Best of Acorn User.

See A-maze-ing, page 88

Listing 1. The "MAZE" game

```

10 REM Maze
20 REM David Lawrence
30 REM BBC B/B+/M/E
40 REM (c) Acorn User
September 1986
50 :
60 IF PAGE>&1100 THEN
PROCrelloc

```

```

70 :
80 MODE 1:HIMEM=&2E00
90 PROCinit
100 REPEAT
110 PROCreset
120 PROCmaze
130 PROCgame
140 PROCend
150 UNTIL done
160 MODE 7
170 *FX 200,0

```

```

180 END
190 :
200 DEF PROCinit
210 VDU 19,1,4;0;19,2,
7;0;19,3,4;0;
220 VDU 23;820;0;0;0;
230 DIM D%(4,2),L%(13)
240 FOR I%=1 TO 4
250 READ D%(I%,1),D%(I
%,2):NEXT

```

Continued ▶

YELLOW PAGES

GAMES

◀ Lawrence's listing 1 continued

```

260 FOR I%=1 TO 13:REA
D LX(I%):NEXT
270 VDU 23,224,255,255
,255,255,255,255,255,255
280 VDU 23,225,0,0,0,0
,0,0,0,0
290 VDU 23,226,0,0,60,
60,60,60,0,0
300 VDU 23,227,129,66,
36,24,24,36,66,129
310 VDU 23,228,255,129
,189,189,185,189,189,189
320 VDU 23,229,24,60,2
4,255,153,60,36,102
330 done=FALSE:M%=&2E0
0
340 rnd=RND(-TIME)
350 *FX 200,1
360 ENDPROC
370 :
380 DEF PROCpoke(xp%,y
p%,by%)
390 ?(M%+xp%+yp%*21)=b
y%
400 ENDPROC
410 :
420 DEF FNpeek(xp%,yp%
)
430 =?(M%+xp%+yp%*21)
440 :
450 DEF PROCreset
460 exit=FALSE:box=FAL
SE:S%=6
470 FOR I%=0 TO 500 ST
EP 4:I%!M%=0
480 NEXT
490 out=FALSE:f%=1
500 VDU 26,12
510 GCOL 0,2:MOVE 16,1
6:PLOT 1,0,288
520 PLOT 1,1248,0:PLOT
1,0,-288
530 PLOT 1,-1248,0
540 MOVE 272,16:PLOT 1
,0,288
550 COLOUR 2:PRINTTAB(
1,30);"Scans:6"
560 ENDPROC
570 :
580 DEF PROCmaze
590 PRINTTAB(0,2)"Plea
se wait, constructing ma
ze>";SPC(99);"<=Finished
when";
600 PRINTSPC(27);"arro
w gets here.";TAB(30,2);
610 X%=1:Y%=1:xm%=2:ym
%=2
620 PROCpoke(2,2,1):N%
=99
630 FOR N%=1 TO 99
640 REPEAT:ok%=TRUE
650 REPEAT
660 D%=RND(4):xx%=X%+D
%(D%,1)
670 yy%=Y%+D%(D%,2)
680 UNTIL xx%>0 AND xx
%<11 AND yy%>0 AND yy%<1
1
690 IF FNpeek(xx%*2,yy
%*2) PROCjump
700 UNTIL ok%
710 FOR I%=1 TO 2
720 PROCpoke(X%*2+I%*D
%(D%,1),Y%*2+I%*D%(D%,2)
,1)
730 NEXT
740 X%=xx%:Y%=yy%:VDU
32,62,8
750 IF X%>xm% xm%=X%
760 IF Y%>ym% ym%=Y%
770 NEXT
780 PROCpoke(RND(10)*2
,1,4)
790 X%=RND(10)*2:Y%=20
:D%=RND(3)+1
800 REPEAT
810 tx%=RND(10)*2:ty%=
RND(10)*2
820 UNTIL tx%<>X% AND
ty%<>Y%
830 PROCpoke(tx%,ty%,2
)
840 ENDPROC
850 :
860 DEF PROCjump
870 REPEAT
880 X%=RND(xm%):Y%=RND
(ym%):ok%=FALSE
890 UNTIL FNpeek(X%*2,
Y%*2)
900 ENDPROC
910 :
920 DEF PROCgame
930 TIME=0
940 REPEAT
950 PROCview(X%,Y%,D%)
960 R%=FNpeek(X%,Y%)
970 IF R%=2 PROCboxfou
nd
980 IF R%=4 PROCexitfo
und
990 IF NOT out PROCmov
e
1000 UNTIL out
1010 ENDPROC
1020 :
1030 DEF PROCview(x%,y%
,d%)
1040 VDU 26,28,0,21,39,
0,12,26
1050 VDU 29,640;800;
1060 GCOL 0,2
1070 MOVE 639,200:PLOT
1,0,-680
1080 PLOT 1,-1279,0:PLO
T 1,0,680
1090 PLOT 1,1279,0
1100 VDU 24,-634;-476;6
34;196;
1110 xa%=D%(d%,1):ya%=D
%(d%,2)
1120 N%=2:x1%=L%(1)
1130 REPEAT
1140 x2%=L%(N%):R%=FNpe
ek(x%,y%)
1150 N%=FNroom(x%,y%,d%
,R%)
1160 x1%=x2%:x%=x%+xa%:
y%=y%+ya%
1170 UNTIL N%=13 OR N%=
0
1180 ENDPROC
1190 :
1200 DEF FNroom(x%,y%,d
%,R%)
1210 IF R%=0 THEN =0
1220 y1%=-x1%*.75:y2%=-
x2%*.75
1230 y3%=x2%*.3125:y4%=
x1%*.3125
1240 FOR i%=-1 TO 1
1250 PROCside(x%,y%,i%)
1260 NEXT
1270 IF FNpeek(x%+D%(d%
,1),y%+D%(d%,2))=0 PROCe
ndwall
1280 IF R%=2 PROCbox
1290 IF R%=3 PROCcross
1300 IF R%=4 PROCexit
1310 =N%+1
1320 :
1330 DEF PROCside(ax%,a
y%,i%)
1340 ax%=ax%+D%(FNturn(
d%-i%),1)
1350 ay%=ay%+D%(FNturn(
d%-i%),2)
1360 r1%=FNpeek(ax%,ay%
)
1370 IF r1%>0 AND i%=0
ENDPROC
1380 IF r1%=0 PROCwall(i
%):ENDPROC
1390 PROCopen(i%)
1400 IF r1%=3 PROCsidec
ross(i%)
1410 ENDPROC
1420 :
1430 DEF FNturn(q%)=(q%
+1) MOD 4+1
1440 :
1450 DEF PROCwall(i%)
1460 IF i%=0 ENDPROC
1470 GCOL 0,d%+i%
1480 IF f% MOVE x1%*i%,
y1%:MOVE x1%*i%,y4%:PLOT
85,x2%*i%,y2%:PLOT 85,x
2%*i%,y3%
1490 GCOL 0,2
1500 MOVE x1%*i%,y1%:DR
AW x1%*i%,y4%
1510 DRAW x2%*i%,y3%:DR
AW x2%*i%,y2%
1520 DRAW x1%*i%,y1%
1530 ENDPROC
1540 :
1550 DEF PROCendwall
1560 GCOL 0,d%
1570 IF f% MOVE -x2%,y2
%:MOVE x2%,y2%:PLOT 85,-
x2%,y3%:PLOT 85,x2%,y3%
1580 GCOL 0,2
1590 MOVE -x2%,y2%:DRAW
x2%,y2%
1600 DRAW x2%,y3%:DRAW
-x2%,y3%
1610 DRAW -x2%,y2%
1620 N%=0
1630 ENDPROC
1640 :

```

Continued ▶

YELLOW PAGES

GAMES

◀ Listing 1 continued

```

1650 DEF PROCopen(i%)
1660 GCOL 0,d%
1670 IF f% MOVE x2%i%,
y2%:MOVE x1%i%,y2%:PLOT
85,x2%i%,y3%:PLOT 85,x
1%i%,y3%
1680 GCOL 0,2
1690 MOVE x2%i%,y2%:DR
AW x1%i%,y2%
1700 DRAW x1%i%,y3%:DR
AW x2%i%,y3%
1710 DRAW x2%i%,y2%
1720 ENDPROC
1730 :
1740 DEF PROCcross
1750 GCOL 0,2
1760 MOVE -x2%,y2%:DRAW
x1%,y1%
1770 MOVE -x1%,y1%:DRAW
x2%,y2%
1780 ENDPROC
1790 :
1800 DEF PROCsidecross(
i%)
1810 GCOL 0,2
1820 MOVE x2%i%,y2%
1830 DRAW x1%i%,(7*y2%
+y1%)/8
1840 ENDPROC
1850 :
1860 DEF PROCbox
1870 GCOL 0,1
1880 wi=x2%/1.5:he=x2%/
10
1890 de=x2%/6:ba=x2%/1.
9
1900 MOVE -wi/2,(y2%+y1
%)/2
1910 PLOT 0,wi,0
1920 PLOT 81,-wi,-he:PL
OT 81,wi,0
1930 PLOT 0,-wi,he:PLOT
0,wi,0
1940 PLOT 85,-ba/2,(y2%
+y1%)/2+de
1950 PLOT 81,ba,0
1960 GCOL 0,2
1970 MOVE -wi/2,(y2%+y1
%)/2
1980 PLOT 1,wi,0
1990 PLOT 1,0,-he:PLOT
1,-wi,0
2000 PLOT 1,0,he
2010 DRAW -ba/2,(y2%+y1
%)/2+de
2020 PLOT 1,ba,0:DRAW w
i/2,(y2%+y1%)/2
2030 ENDPROC
2040 :
2050 DEF PROCexit
2060 IF D%<>3 ENDPROC
2070 wi=x2%/1.5:he=x2%/
1.2
2080 GCOL 0,0
2090 IF f% MOVE -wi/2,y
2%:PLOT 0,wi,0:PLOT 81,-
wi,he:PLOT 81,wi,0
2100 GCOL 0,2:MOVE -wi/
2,y2%
2110 PLOT 1,0,he
2120 PLOT 1,wi,0:PLOT 1
,0,-he
2130 ENDPROC
2140 :
2150 DEF PROCmove
2160 REPEAT:go%=TRUE:*F
X 21
2170 REPEAT:k%=GET$
2180 UNTIL INSTR("FCSZX
:/",k%)
2190 IF k%="F" f%=1-f%:
SOUND 1,-10,200,1
2200 IF k%="C" go%=FNdo
cross
2210 IF k%="S" go%=FNsc
an
2220 IF k%="Z" D%=D%-1:
IF D%=0 D%=4
2230 IF k%="X" D%=D%+1:
IF D%=5 D%=1
2240 IF k%="/" D%=D%+2:
IF D%>4 D%=D%-4
2250 IF k%=":" go%=FNf
orward
2260 UNTIL go%
2270 ENDPROC
2280 :
2290 DEF FNforward
2300 ax%=X%+D%(D%,1):ay
%=Y%+D%(D%,2)
2310 IF FNpeek(ax%,ay%)
=0 THEN =0
2320 X%=ax%:Y%=ay%
2330 =1
2340 :
2350 DEF FNdocross
2360 p%=FNpeek(X%,Y%)
2370 IF p%=3 OR p%=4 TH
EN =0
2380 PROCpoke(X%,Y%,3)
2390 GCOL 0,2
2400 MOVE -484,-363:DRA
W 774,-580
2410 MOVE -774,-580:DRA
W 484,-363
2420 =0
2430 :
2440 DEF FNscan
2450 LOCAL I%,J%
2460 IF S%=0 SOUND 1,-1
5,20,1:=0
2470 S%=S%-1:PRINTTAB(7
,30);S%
2480 VDU 28,1,30,7,23
2490 old%=FNpeek(X%,Y%)
2500 PROCpoke(X%,Y%,5)
2510 FOR I%=X%-3 TO X%+
3
2520 FOR J%=Y%-3 TO Y%+
3
2530 IF I%<1 OR I%>21 O
R J%<1 OR J%>21ch%=225 E
LSE ch%=224+FNpeek(I%,J%
)
2540 io%=I%-X%+3:jo%=J%
-Y%+3:VDU 31
2550 IF D%=1 VDU io%,6-
jo%
2560 IF D%=2 VDU 6-jo%,
6-io%
2570 IF D%=3 VDU 6-io%,
jo%
2580 IF D%=4 VDU jo%,io
%
2590 VDU ch%
2600 NEXT:NEXT
2610 VDU 26
2620 PROCpoke(X%,Y%,old
%)
2630 =0
2640 :
2650 DEF PROCboxfound
2660 VDU 28,9,30,38,23
2670 PRINT"Well Done! -
You have found""the tr
easure.""
2680 IF exit PRINT"Now
get back to the exit aga
in"
2690 IF NOT exit PRINT"
Now go and find the exit
"
2700 PRINT"" Press <SP
ACE> to continue."
2710 REPEAT
2720 UNTIL INKEY=99:VDU
12,26
2730 box=TRUE:PROCpoke(
X%,Y%,1)
2740 ENDPROC
2750 :
2760 DEF PROCexitfound
2770 IF exit AND NOT bo
x ENDPROC
2780 VDU 28,9,30,38,23
2790 IF box out=TRUE:EN
DPROC
2800 PRINT"Well Done! -
You have found""the ex
it.""
2810 PRINT"However, you
have not found""the tr
easure. GO AND FIND IT!"
2820 PRINT"" Press <SPA
CE> to continue."
2830 REPEAT
2840 UNTIL INKEY=99
2850 VDU 12,26:exit=TRU
E
2860 ENDPROC
2870 :
2880 DEF PROCend
2890 t%=TIME
2900 VDU 28,0,21,39,0,1
2,26
2910 VDU 28,9,21,30,0
2920 FOR i%=21 TO 1 STE
P -1
2930 FOR j%=1 TO 21
2940 VDU 224+FNpeek(j%,
i%)
2950 NEXT:PRINT
2960 NEXT
2970 VDU 28,9,30,38,23
2980 PRINT"Well Done! -
You have found""the e
xit. ";
2990 PRINT"You took >";
t% DIV 360000 MOD 24;";"
;t% DIV 6000 MOD 60;

```

Continued ▶

YELLOW PAGES

GRAPHICS

◀ Lawrence's listing 1 continued

```

3000 PRINT".":t% DIV 10
0 MOD 60;"<"
3010 PRINT'"Do you wan
t another game (Y/N)"
3020 REPEAT
3030 k$=GET$
3040 UNTIL k$="Y" OR k$
="N"
3050 IF k$="N" done=TRU
E
3060 ENDPROC
3070 :
3080 DEF PROCreloc
3090 PRINT"Relocating..
."
3100 *TAPE
3110 *KEYO FOR X%=0 TO
(TOP-PAGE) STEP 4:X%:&11
00=X%:PAGE:NEXT:PAGE=&11
00!MOLD!MRUN!F!M
3120 VDU 21:*FX 138,0,1
28
3130 END
3140 :
3150 DATA 0,1,1,0,0,-1,
-1,0
3160 DATA 774,484,300,2
08,156
3170 DATA 120,96,76,56,
40,28,16,0

```

See Clever Calligraphy, page 93

Listing 1. Prints out ornamental lettering resembling italic script

```

10 REM Calligraphy
20 REM by Mike Turner
30 REM for BBC B/B+/M
/E with Plus 1
40 REM and Epson-comp
atable printers
50 REM (c) Acorn User
September 1986
60 :
70 ON ERROR PROCerror
80 MODE 6
90 VDU 19,1,2,0,0,0
100 *FX 15,1
110 font$=CHR$(32)+"AB
CDEFGHIJKLMNOPQRSTUVWXYZ
"
120 fullwidth=960
130 n1=fullwidth MOD 2
56
140 n2=fullwidth DIV 2
56
150 INPUTTAB(0,10)"Nam
e of file to be printed?
"file$
160 c=OPENUP(file$)
170 REPEAT
180 PROCfile
190 PROCcontrols
200 PROCswitchon
210 PROClinespace
220 PROCcentre
230 PROClayout
240 FOR section%=1 TO
4
250 strikes%=0
260 PROCgrafix
270 PROCfill(lead)
280 PROCstrip(writing$
)
290 VDU 1,13,1,10
300 NEXT
310 UNTIL EOF#c
320 CLOSE#c
330 VDU 3
340 END
350 :
360 DEF PROCswitchon
370 VDU 2,1,27,1,64
380 ENDPROC
390 :
400 DEF PROClinespace
410 VDU 1,27,1,ASC("A"
),1,8
420 ENDPROC
430 :
440 DEF PROCcentre
450 sp=0
460 spaces%=fullwidth
470 strikes%=0
480 FOR N%=1 TO LEN(wr
iting$)
490 PROCletter
500 IF letter$=CHR$(32
) THEN sp=sp+1
510 PROCskip
520 READ width%
530 spaces%=spaces%-wi
dth%
540 NEXT
550 ENDPROC
560 :
570 DEF PROCletter
580 letter$=MID$(writi
ng$,N%,1)
590 IF INSTR(font$,let
ter$)=0 THEN letter$=CHR
$(32)
600 ENDPROC
610 :
620 DEF PROCgrafix
630 VDU 1,27,1,ASC("L"
),1,n1,1,n2
640 ENDPROC
650 :
660 DEF PROCstrip(w$)
670 FOR N%=1 TO LEN(w$
)
680 PROCletter
690 PROCskip
700 PROCprint
710 NEXT
720 right%=fullwidth-s
trikes%
730 IF right%>0 THEN P
ROCfill(right%)
740 ENDPROC
750 :
760 DEF PROCrestore
770 PROCskip
780 IF section%=1 OR s
ection%=4 OR ASCletter$=
32 ENDPROC
790 PROCskipline(secti
on%-1)
800 ENDPROC
810 :
820 DEF PROCfill(j%)
830 IF j%=0 THEN ENDR
OC
840 FOR data%=1 TO j%
850 VDU 1,0
860 strikes%=strikes%+
1
870 NEXT
880 ENDPROC
890 :
900 DEF PROCprint
910 PROCrestore
920 READ width%
930 IF letter$=CHR$(32
) THEN PROCfill(spaces%)
940 IF section%=4 THEN
PROCfill(width%):ENDPRO
C
950 FOR data=1 TO widt
h%
960 READ dots$
970 dots$="&"+dots$
980 dots%=EVAL(dots$)
990 VDU 1,dots%
1000 strikes%=strikes%+
1
1010 NEXT
1020 ENDPROC
1030 :
1040 DEF PROCcontrols
1050 lj=0:rj=0:ce=0:ms=
0:control$=""
1060 IF LEFT$(writing$,
1)=CHR$(128) THEN contro
l$=MID$(writing$,2,2):co
ntrol=TRUE ELSE lj=TRUE:
control=FALSE
1070 IF control THEN wr
iting$=MID$(writing$,4)
1080 ENDPROC
1090 :
1100 DEF PROClayout
1110 IF control$="LJ" T
HEN lj=TRUE
1120 IF control$="RJ" T
HEN rj=TRUE
1130 IF control$="CE" T
HEN ce=TRUE
1140 IF control$="MS" T
HEN ms=TRUE
1150 IF lj THEN lead=0:
spaces%=0
1160 IF rj THEN lead=sp
aces%:spaces%=0
1170 IF ce THEN lead=sp
aces% DIV 2:spaces%=0

```

Continued ▶

YELLOW PAGES

GRAPHICS

◀ Listing 1 continued

```

1180 IF ms THEN lead=0:
spaces%=spaces% DIV sp
1190 ENDPROC
1200 :
1210 DEF PROCfile
1220 writing$=""
1230 REPEAT
1240 x=BGET#c
1250 IF x<>13 THEN writ
ing$=writing$+CHR$(x)
1260 UNTIL x=13
1270 ENDPROC
1280 :
1290 DEF PROCskip
1300 char%=ASCletter$
1310 RESTORE
1320 IF char%<65 ENDPRO
C
1330 PROCskipline(1)
1340 IF char%=65 ENDPRO
C
1350 FOR c%=0 TO (char%
-66)
1360 PROCskipline(3)
1370 NEXT
1380 ENDPROC
1390 :
1400 DEF PROCskipline(n
%)
1410 FOR line%=1 TO n%
1420 READ w%
1430 FOR k%=1 TO w%:REA
D d$
1440 NEXT:NEXT
1450 ENDPROC
1460 :
1470 DEF PROCerror
1480 CLOSE#0
1490 VDU 3
1500 PRINT:REPORT:PRINT
" at line ";ERL
1510 END
1520 :
1530 REM space
1540 DATA 16,0,0,0,0,0,
0,0,0,0,0,0,0,0,0,0
1550 :
1560 REM A
1570 DATA 22,0,0,0,0,0,
0,0,0,1,7,1C,70,F0,FF,FF
,F,0,0,0,0,0,0
1580 DATA 22,0,0,0,0,1,
7,1F,73,C3,3,3,3,3,3,F3,
FF,FF,F,0,0,0,0
1590 DATA 22,1,7,1C,70,
C0,80,80,80,80,80,80,80,
80,80,80,80,F0,FF,FF,F,1
,2
1600 :
1610 REM B
1620 DATA 21,0,10,3F,7F
,FF,30,60,60,C0,C0,C0,C0
,C0,C0,C0,E3,FF,7F,3C,0,
0
1630 DATA 21,0,FF,FF,FF
,30,30,30,30,30,30,30,30
,30,7B,FC,DC,9E,F,7,3,0
1640 DATA 21,FF,FF,FF,E
,7,3,3,3,3,3,3,3,3,7,F
,1E,FC,F8,F0,0
1650 :
1660 REM C
1670 DATA 19,0,1,7,1F,1
C,38,70,60,E0,C0,C0,C0,C
0,C0,E0,F0,7F,3E,1C
1680 DATA 19,7F,FF,FF,0
,0,0,0,0,0,0,0,0,0,0,0,0
0,0,0,0
1690 DATA 19,F8,FC,FE,1
F,F,7,3,3,3,3,3,7,7,E,1C
,38,60,80,0
1700 :
1710 REM D
1720 DATA 22,0,0,40,C0,
FF,FF,FF,C0,C0,C0,C0,C0,
C0,C0,C0,C0,E0,F0,F8,7F,
3F,1F
1730 DATA 22,0,0,0,FF,F
F,FF,0,0,0,0,0,0,0,0,0,0
,0,0,0,FF,FF,FE
1740 DATA 22,1,3,FF,FF,
FF,3,3,3,3,3,3,3,7,6,E
,1C,38,F0,E0,80,0
1750 :
1760 REM E
1770 DATA 23,0,10,20,60
,FF,FF,FF,E0,E0,E0,E0,E0
,E0,E0,E0,E0,E0,E0,E0,E0
,E0,C0,80
1780 DATA 23,0,10,30,7F
,FF,FF,F0,70,70,70,70,70
,60,40,0,0,0,0,0,0,0,0,0
1790 DATA 23,1,3,7F,FF,
FF,87,7,7,7,7,7,7,7,7,7,
7,7,7,7,7,6,4,8
1800 :
1810 REM F
1820 DATA 23,10,20,60,F
F,FF,FF,E0,E0,E0,E0,E0,E
0,E0,E0,E0,E0,E0,E0,E0,E
0,C0,80
1830 DATA 23,10,30,7F,F
F,FF,F0,70,70,70,70,70,7
0,60,40,0,0,0,0,0,0,0,0,0
,0
1840 DATA 23,0,7F,FF,FF
,81,2,0,0,0,0,0,0,0,0,0,0
,0,0,0,0,0,0,0,0
1850 :
1860 REM G
1870 DATA 20,0,1,7,1F,1
C,38,70,60,E0,C0,C0,C0,C0
,C0,E0,F0,7F,3E,1C,0
1880 DATA 20,7F,FF,FF,0
,0,0,0,0,2,4,C,1C,1C,1C,
1C,1C,1F,1F,1F,0
1890 DATA 20,F8,FC,FE,1
F,F,7,3,3,3,3,3,7,6,E,1C
,7F,FF,FF,81,2
1900 :
1910 REM H
1920 DATA 20,0,10,3F,7F
,FF,0,0,0,0,0,0,0,0,0,0,0
,0,10,3F,7F,FF
1930 DATA 20,0,7F,FF,FF
,8B,38,38,38,38,38,38,38
,38,38,38,38,7F,FF,FF,80
1940 DATA 20,7F,FF,FF,8
0,0,0,0,0,0,0,0,0,0,0,0,0
,7F,FF,FF,81,2
1950 :
1960 REM I
1970 DATA 15,0,0,10,20,
60,E0,E0,FF,FF,FF,E0,E0,
E0,C0,80
1980 DATA 15,0,0,0,0,0,0,
0,7F,FF,FF,80,0,0,0,0,0,0
1990 DATA 15,1,3,7,7,7,
7F,FF,FF,87,7,6,4,8,0,0
2000 :
2010 REM J
2020 DATA 24,0,0,10,20,
60,E0,E0,E0,E0,E0,E0,E0
,E0,E0,FF,FF,FF,E0,E0,E0
,E0,E0,C0,80
2030 DATA 24,0,0,0,0,0,0,
0,0,0,0,0,0,0,0,FF,FF,FF
,0,0,0,0,0,0,0,0,0
2040 DATA 24,2,6,F,1F,7
,3,3,3,3,3,3,6,E,F8,F0,8
0,0,0,0,0,0,0,0,0,0
2050 :
2060 REM K
2070 DATA 19,0,10,3F,7F
,FF,0,0,0,0,0,1,3,6,C,18
,30,60,C0,80
2080 DATA 19,0,FF,FF,FF
,6,C,18,30,60,F8,FE,1F,7
,1,0,0,0,0,0,0
2090 DATA 19,FF,FF,FF,0
,0,0,0,0,0,0,80,E0,F8,
7E,1F,7,1,2
2100 :
2110 REM L
2120 DATA 22,0,0,0,10,3
F,7F,FF,0,0,0,0,0,0,0,0,0
,0,0,0,0,0,0,0
2130 DATA 22,0,0,0,7F,F
F,FF,80,0,0,0,0,0,0,0,0,0
,0,0,0,0,0,0,0
2140 DATA 22,1,3,7F,FF,
FF,87,7,7,7,7,7,7,7,7,7,
7,7,7,7,6,4,8
2150 :
2160 REM M
2170 DATA 27,0,10,3F,7F
,FF,C,18,30,60,C0,C0,C0,
E0,7F,7F,3F,C,18,30,60,C
0,C0,C0,E0,FF,7F,3F
2180 DATA 27,0,FF,FF,FF
,0,0,0,0,0,0,0,0,0,FF,FF,F
F,0,0,0,0,0,0,0,0,FF,FF,
FF,0
2190 DATA 27,FF,FF,FF,0
,0,0,0,0,0,0,0,0,FF,FF,FF
,0,0,0,0,0,0,0,0,FF,FF,FF
,2,4
2200 :
2210 REM N
2220 DATA 21,0,10,3F,7F
,FF,6,C,18,30,60,E0,C0,C
0,C0,C0,C0,E0,FF,7F,3F,0
2230 DATA 21,0,FF,FF,FF
,0,0,0,0,0,0,0,0,0,0,0,0,0
,FF,FF,FF,0,0
2240 DATA 21,FF,FF,FF,0
,0,0,0,0,0,0,0,0,0,0,0,0,F
F,FF,FF,1,2,0
2250 :

```

Continued ▶

YELLOW PAGES

GRAPHICS

◀ Turner's listing 1 continued

```

2260 REM D
2270 DATA 21,0,1,7,1F,1
C,38,70,60,E0,C0,C0,C0,C
0,C0,E0,F0,F8,7F,3F,1F,0
2280 DATA 21,7F,FF,FF,0
,0,0,0,0,0,0,0,0,0,0,0,0
,0,FF,FF,FE,0
2290 DATA 21,F8,FC,FE,1
F,F,7,3,3,3,3,3,7,6,E,C,
38,F8,E0,80,0,0
2300 :
2310 REM P
2320 DATA 20,0,10,3F,7F
,FF,1C,30,60,60,C0,C0,C0
,C0,C0,C0,E0,78,7F,1F,F
2330 DATA 20,0,7F,FF,FF
,8C,6,6,3,3,3,3,6,6,6,C,
18,78,F0,E0,80
2340 DATA 20,FF,FF,FF,C
1,2,0,0,0,0,0,0,0,0,0,0,0
,0,0,0,0,0
2350 :
2360 REM Q
2370 DATA 24,0,1,7,1F,3
C,30,70,60,E0,C0,C0,C0,C
0,C0,E0,F0,F8,7F,3F,1F,0
,0,0,0
2380 DATA 24,7F,FF,FF,0
,0,0,0,0,0,1,1,1,1,0,0,0
,0,FF,FF,FE,0,0,0,0
2390 DATA 24,F8,FC,FE,1
F,F,7,3,43,83,83,83,C7,E
6,FE,7C,3C,FE,EF,87,3,3,
2,2,C
2400 :
2410 REM R
2420 DATA 20,0,10,3F,7F
,FF,30,60,E0,C0,C0,C0,C0
,C0,C0,E0,F0,7F,3F,1F,0
2430 DATA 20,0,FF,FF,FF
,18,18,18,18,18,18,18,18
,3C,3E,6F,E7,C3,80,0,0
2440 DATA 20,FF,FF,FF,0
,0,0,0,0,0,0,0,0,0,0,E0,
FF,FF,1F,1,2

```

```

2450 :
2460 REM S
2470 DATA 20,0,0,F,1F,3
F,38,70,60,E0,C0,C0,C0,C
0,C0,E0,F0,7F,3E,1C,8
2480 DATA 20,0,0,80,C1,
E0,E0,60,70,30,30,18,18,
1C,C,E,7,7,3,1,0
2490 DATA 20,3C,7E,FF,F
,7,3,3,3,3,3,3,3,3,7,7,1
E,FC,F8,F0,0
2500 :
2510 REM T
2520 DATA 24,10,20,60,E
0,E0,E0,E0,E0,E0,FF,F
F,FF,E0,E0,E0,E0,E0,E0,E
0,E0,E0,C0,80
2530 DATA 24,0,0,0,0,0,0,
0,0,0,0,FF,FF,FF,0,0,0,0
,0,0,0,0,0,0,0,0
2540 DATA 24,0,0,0,0,0,0,
0,0,0,FF,FF,FF,0,0,0,0,0
,0,0,0,0,0,0,0,0,0
2550 :
2560 REM U
2570 DATA 20,0,10,3F,7F
,FF,0,0,0,0,0,0,0,0,0,0,0
,0,10,3F,7F,FF
2580 DATA 20,1,FF,FF,FE
,0,0,0,0,0,0,0,0,0,0,0,1
,FF,FF,FE,0
2590 DATA 20,F0,FC,FE,1
F,7,3,3,3,3,3,7,6,C,18,3
8,FF,FF,FF,1,2
2600 :
2610 REM V
2620 DATA 18,10,30,7F,F
F,F,0,0,0,0,0,0,0,0,0,3,
E,38,E0
2630 DATA 18,0,0,0,F0,F
F,FF,F,0,0,0,3,E,38,E0,8
0,0,0,0
2640 DATA 18,0,0,0,0,F0
,FF,FF,F,38,E0,80,0,0,0,
0,0,0,0
2650 :

```

```

2660 REM W
2670 DATA 26,10,30,7F,F
F,F,0,0,10,30,7F,FF,F,0,
0,0,0,0,0,0,0,0,0,3,E,38
,E0
2680 DATA 26,0,0,0,F0,F
F,FF,F,0,0,0,F0,FF,FF,F,
0,0,0,0,3,E,38,E0,80,0,0
,0
2690 DATA 26,0,0,0,0,0,
F0,FF,FF,F,38,E0,80,F0,F
F,FF,F,38,E0,80,0,0,0,0,
0,0,0
2700 :
2710 REM X
2720 DATA 24,0,0,80,C0,
F0,F8,7E,3F,F,7,1,0,0,0,
0,0,1,3,6,C,18,30,60,C0
2730 DATA 24,0,0,0,0,0,0,
0,0,0,C1,E3,F6,FE,3F,3F,
67,C1,80,0,0,0,0,0,0,0
2740 DATA 24,1,3,6,C,18
,30,60,C0,80,0,0,0,0,C0,
E0,F8,FE,3F,F,7,1,0,0,0
2750 :
2760 REM Y
2770 DATA 19,11,3F,7F,F
E,0,0,0,0,0,0,0,0,0,0,0,0
,11,3F,7F,FE
2780 DATA 19,F8,FE,FF,7
,3,1,1,1,1,1,1,3,6,C,18,
FF,FF,FF,0
2790 DATA 19,0,0,2,86,8
F,9F,87,83,83,83,83,83,3
,6,E,FC,F0,80,0
2800 :
2810 REM Z
2820 DATA 24,0,0,0,10,2
0,60,E0,E0,E0,E0,E0,E0,E
0,E0,E1,E3,E6,EC,F8,F0,E
0,C0,80,0
2830 DATA 24,0,0,0,0,0,0,
0,0,0,3,7,C,18,30,E0,C0,
0,0,0,0,0,0,0,0,0,0
2840 DATA 24,1,3,7,F,1F
,37,67,C7,87,7,7,7,7,7,7
,7,7,7,7,7,7,6,4,8

```

Listing 2. Creates a file of text for listing 1

```

10 REM Calligraphy Fi
le Creator
20 REM by Mike Turner
30 REM for BBC B/B+/M
/E
40 REM (c) Acorn User
September 1986
50 :
60 ON ERROR CLS:CLOSE
#0:REPORT:PRINT" at line
";ERL:END
70 MODE 3
80 VDU 19,1,2,0,0,0
90 REPEAT
100 INPUTTAB(0,10) "Nu
mber of lines of print (
max 22) "lines
110 UNTIL lines<=22 AN
D lines>0
120 DIM entry$(lines)

```

```

130 VDU 19,1,2,0,0,0
140 FOR N%=1 TO lines
150 REPEAT
160 PRINT "Line ";N%;"
:~";
170 INPUT LINE entry$(
N%)
180 IF LEN(entry$(N%))
>60 THEN VDU7:PRINT "Lin
e too long - try again"
190 UNTIL LEN(entry$(N
%))<=60
200 NEXT
210 VDU 7
220 PRINT"Page complet
ed"
230 INPUT"Name of file
to be saved",file$
240 g=OPENOUT file$
250 REPEAT

```

```

260 FOR N%=1 TO lines
270 FOR letter=1 TO LE
N(entry$(N%))
280 IF entry$(N%)="" T
HEN entry$(N%)=CHR$(32)
290 byte%=MID$(entry$(
N%),letter,1)
300 byte=ASC(byte%)
310 IF byte>128 THEN b
yte=128
320 BPUT#g,byte
330 NEXT letter
340 BPUT#g,&D
350 NEXT N%
360 CLOSE#g
370 VDU 7
380 PRINT"File saved a
s <";file%;">"
390 END

```

CHARTS

Check out the latest position of your favourite game

TOP 20 BBC MICRO GAMES

Title	Publisher	Cassette	Disc	B +	Master	Reviewed
1 (1) Commando	Elite	£9.95	£14.95	*	*	August '86
2 (3) Tennis	Bug-Byte	£2.99	-	*	*	September '86
3 (2) Winter Olympics	Tynesoft	£9.95	-	*	*	September '86
4 (4) Bruce Lee	US Gold	£9.95	£14.95	No	No	August '86
5 (5) Karate Combat	Superior	£8.95	£11.95	Yes	Yes	July '86
6 (-) Jack Attac	Bug-Byte	£2.99	-	(a)	(a)	September '86
7 (-) Galactic Patrol	Mastertronic	£1.99	-	No	No	-
8 (-) Jet Set Willy	Tynesoft	£7.95	£9.95	Yes	Yes	-
9 (11) Yie Ar Kung Fu	Imagine	£9.95	£12.95	No	No	March '86
10 (6) Phantom Combat	Doctor Soft	£9.95	£11.95	Yes	Yes	February '86
11 (7) Citadel	Superior	£9.95	£11.95	Yes	*	March '86
12 (8) Computer Hits 10 Vol 2	Beau Jolly	£9.95	-	Yes	No	-
13 (14) Cosmic Battle Zones	US Gold	£9.95	-	No	No	-
14 (-) Great Wall	Artic	£1.99	-	*	*	-
15 (12) Repton 2	Superior	£9.95	£11.95	Yes	*	December '85
16 (16) Combat Lynx	Durell	£8.95	-	Yes	*	September '85
17 (-) Savage Pond	Bug-Byte	2.99	-	(a)	(a)	-
18 (-) Star Force 7	Bug-Byte	£2.99	-	Yes	*	-
19 (-) Dr Who and the Mines of Terror	Micropower	(b)	(b)	No	No	March '86
20 (-) Ian Botham Test Cricket	Tynesoft	£7.95	£11.95	Yes	Yes	-

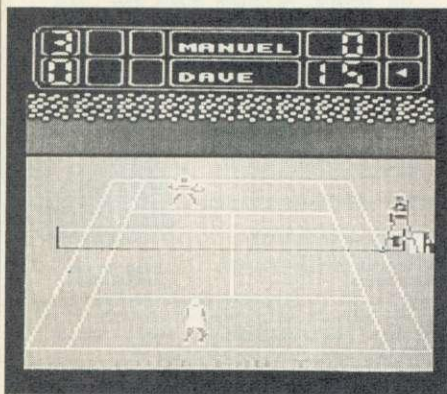

Tennis: this month's no. 2

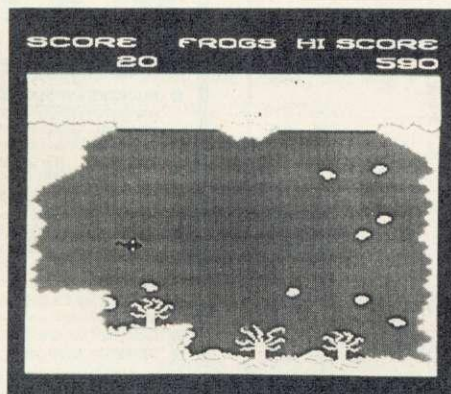

Beneath the surface of the Savage Pond

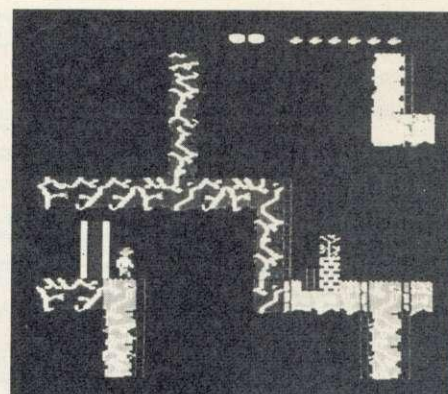

Highest new entry: Jack Attac

TOP 10 ELECTRON GAMES

Title	Publisher	Cassette	Disc	Reviewed
1 (-) Galactic Patrol	Mastertronic	£1.99	-	-
2 (1) Commando	Elite	£9.95	£14.95	August '86
3 (2) Computer Hits 10 Vol 2	Beau Jolly	£9.95	-	-
4 (5) Tennis	Bug-Byte	£2.99	-	September '86
5 (-) Jet Set Willy	Tynesoft	£7.95	£9.95	-
6 (-) Jack Attac	Bug-Byte	£2.99	-	September '86
7 (3) Yie Ar Kung Fu	Imagine	£9.95	£12.95	March '86
8 (-) Savage Pond	Bug-Byte	£2.99	-	-
9 (4) Way of the Exploding Fist	Melbourne House	£9.95	-	April '86
10 (6) Walk the Plank	Mastertronic	£1.99	-	-

COMPILED BY GALLUP/MICROSCOPE

*PLEASE CHECK B+/MASTER COMPATIBILITY BEFORE BUYING; (a) PROGRAM NEEDS CONVERTING; (b) INCLUDES 16K ROM

PART EXCHANGE YOUR BBC FOR ANYTHING WE CARRY IN STOCK



AMSTRAD	
PCW8256	£458.85
PCW8512	£573.85
BBC MASTER 128	£449.00
TURBO UPGRADE	£125.00
WRITE PROTECT SWITCH FOR MASTER	£9.95
CUMANA DISK SYSTEMS	
CSX100L	£79.95
CSX400S	£125.35
CS100	£102.35
CS400	£159.85
CD200	£188.60
CD800S	£251.85
PRINTERS	
KAGA KP810	£263.35
CANON PW1080A	£286.35
PJ1080A	£458.85
EPSON LX80	£217.35
JUKI 6100	£251.85
6200	£516.35
MONITORS	
MICROVITEC	
1431	£193.20
1451	£251.85
1431AO	£251.85
1451AP	£286.35
KAGA/TAXAN 12"	£113.85
PHILIPS 12"	£90.85

We will accept your BBC computer, any age, any condition, even non-working, in part exchange for any product we normally hold in stock. This offer applies to both BBC products and Amstrad computers.

A selection from our product range is shown here, and as you can see, our prices are very competitive. The allowance you can expect for your machine is detailed in the table opposite.

Just send your BBC (and manual please) to us with a cheque or credit card number, and provided we have the item you require in stock (please phone to check), it will be sent by return.

This offer means that Compshop has a number of second hand BBC 32K machines for sale, all with 3 months warranty. So if you want a BBC but can't afford a new one, phone us for prices and availability.

ALL PRICES INCLUDE VAT CARRIAGE ON ANY ITEM
POST - £3.00 COURIER - £10.00

ALLOWANCE ON YOUR OLD MACHINE

	MORE THAN TWO YEARS OLD	TWO OR LESS YEARS OLD
WITHOUT ACORN DISK INTERFACE	£125	£175
WITH ACORN DISK INTERFACE	£175	£225

PLEASE DEDUCT £25 IF YOUR BBC HAS ANY FAULTS

COMPSHOP PRICE PROMISE
- We guarantee to match the price on equipment offered from stock through any other supplier.

COMPSHOP was established in 1978 and has continually offered the best in micro computers to discerning customers.

Educational enquiries and orders welcome.

Quotations given.

One year warranty on all products.



We sell only computers and peripherals, and therefore can offer the support many other shops cannot.



14 Station Road, New Barnet, Hertfordshire, EN5 1QW
(Close to New Barnet BR Station - Moorgate Line)

Telephone: 01-441 2922 (Sales) 01-449 6596 Telex: 298755 TELCOM G
OPEN (BARNET) - 10am - 7pm - Monday to Saturday AA287

SELECTED BBC/ ELECTRON PROGRAMS

BBC SOFTWARE TITLE	OUR RRP PRICE		
COMMANDO	9.95	7.50	
YIE AR KING FU	9.95	7.50	
EXPLODING FIST	9.95	7.50	
BRUCE LEE	9.95	7.50	
COSMIC BATTLEZONES	9.95	7.50	
JUMP JET	9.95	7.50	
MOON CRESTA	7.95	6.50	
BUG EYES 2	7.95	6.50	
WINTER OLYMPICS	7.95	6.50	
STEVE DAVIS SNOOKER	8.95	6.95	
RICK HANSON	9.95	7.95	
PROJECT THESIUS	9.95	7.95	
THRUST	7.95	6.50	
WORM IN PARADISE	9.95	7.95	
SABRE WOLF	9.95	7.50	
REPTON	9.95	7.50	
REPTON 2	9.95	7.50	
SPEECH	9.95	7.50	
CITADEL	9.95	7.50	
NIGHTSHADE	9.95	7.50	
STRIKE FORCE HARRIER	9.95	7.50	
KARATE COMBAT	8.95	6.95	
PHANTOM COMBAT	9.95	7.50	
SCRABBLE	12.95	10.95	
MONOPOLY	12.95	10.95	
AIRWOLF	9.95	7.50	
PRICE OF MAGIK	9.95	7.50	
MINI OFFICE 2	14.95	12.45	
10 COMPUTER HITS 2	9.95	7.50	
LORD OF THE RINGS	15.95	13.95	
BOMB JACK	9.95	7.50	
SOUTHERN BELLE	7.95	6.50	
CAVE MAN CAPERS	7.95	6.50	
BBC DISC SOFTWARE			
MINI OFFICE 2	16.95	14.95	
HYPER SPORTS	12.95	10.95	
ENTHAR 7	15.95	14.95	
RICK HANSON	11.95	10.45	
PROJECT THESIUS	11.95	10.45	
SPEECH	11.95	10.45	
EXPLODING FIST	14.95	12.95	
YIE AR KING FU	12.95	10.95	
CITADEL	11.95	10.45	
GRAPHIC ADV CREATOR	27.95	22.95	
SCRABBLE	14.95	12.95	
THE HOBBIT	17.95	15.95	
LORD OF THE RINGS	19.95	16.95	
KARATE COMBAT	11.95	10.45	
BRUCE LEE	14.95	12.95	
MOON CRESTA	9.95	7.50	
OLYMPIC DECATHLON	9.95	7.50	
THE QUILL	22.95	19.95	
ELECTRON SOFTWARE			
COMMANDO	9.95	7.50	
EXPLODING FIST	9.95	7.50	
YIE AR KING FU	8.95	6.95	
10 COMPUTER HITS 2	9.95	7.50	
CITADEL	9.95	7.50	
THRUST	7.95	6.50	
WINTER OLYMPICS	7.95	6.50	
RICK HANSON	9.95	7.95	
PROJECT THESIUS	9.95	7.95	
BOMB JACK	9.95	7.50	

ALL PRICES INCLUDE VAT AND POSTAGE & PACKING
(Overseas Orders add £1.00 per item)

CHEQUES/PO PAYABLE TO: C & F ASSOCIATES AND
SEND TO C & F ASSOCIATES (AU) PO BOX 2, BIDEFORD
EX39 3RE

Tel: (023 73) 619

ORDERS NORMALLY DESPATCHED WITHIN 24 HOURS
OF RECEIPT BUT MAXIMUM OF 7 DAYS

AA208A

POOLSWINNER

THE ULTIMATE POOLS PREDICTION PROGRAM

- **MASSIVE DATABASE** Poolswinner is a sophisticated Pools prediction aid. It comes complete with the largest database available - 22000 matches over 10 years. The database updates automatically as results come in.
- **PREDICTS** Not just SCOREDRAWS, but ALWAYS, HOMES and NO SCORES.
- **SUCCESSFUL** SELEC guarantee that Poolswinner performs significantly better than chance.
- **ADAPTABLE** Probabilities are given on every fixture - choose as many selections as you need for your bet. The precise prediction formula can be set by the user - you can develop and test your own unique method.
- **SIMPLE DATA ENTRY** All team names are in the program. Simply type in the reference numbers from the screen. Or use FIXGEN to produce fixture list automatically (see below).
- **DISC/MICRODRIVE COMPATIBLE** Tapes supplied with conversion instructions.
- **PRINTER SUPPORT** Full hard copy printout of data if you have a printer.

PRICE £15.00 (all inclusive)

NOW AVAILABLE

FIXGEN 86/7

AT LAST! No more struggling for hours to get the fixture list into the computer. FIXGEN has been programmed with all English and Scottish fixtures for 1986/7. Simply type in the date, and the full fixture list is generated in seconds. Fully compatible with Poolswinner. Yearly updates available.

POOLSWINNER with FIXGEN £16.50 (for both)



COURSEWINNER v3

THE PUNTERS COMPUTER PROGRAM

You can develop and test your own unique winning system by adjusting the analysis formula, or use the program in simple mode. Coursewinner V3 uses statistical analysis of major factors including past form, speed ratings, course statistics, prize money, weight, going, trainer and jockey form etc. etc. It outputs most likely winners, good long odds bets, forecasts, tricasts etc. The database includes vital course statistics for all British courses. You can update the database - never goes out of date.

PRICE £15.00 (all inclusive) includes Flat AND National Hunt versions.

ALL PROGRAMS AVAILABLE FOR: AMSTRAD CPCs, AMSTRAD PCWs (ADD £3.00), ALL BBCs, ALL SPECTRUMS, COMMODORE 64/128, ATARI (48K+), SINCLAIR QL
Supplied on tape (simple conversion to disc) - except PCW (on 3" disc) and QL (on microdrive)

Send Cheques/POs for return of post service to ...



phone 24 hrs



SOFTWARE



phone 24 hrs

37 COUNCILLOR LANE, CHEADLE, CHESHIRE. ☎ 061-428 7425

(Send for full list of our software)

REVIEWS

GAMES

A BLAST OF FUN



'Deathstar', Superior, BBC B/B+, £9.95 (cassette), £11.95 (disc). Version reviewed: BBC B

There's nothing particularly novel about this piece of software, but it's written to the high standards we've come to expect from Superior, is enjoyable to play and has a high addiction factor despite its lack of originality.

It's a high-speed arcade game that revolves around a revolving space ship. You use two keys to spin it clockwise or anti-clockwise, *Asteroids*-style. Left to its own devices, it will accelerate off in whatever direction it's pointing, whereupon the screen scrolls impressively smoothly. Your spacecraft shares the cosmos with some lumpy planetoids, some nasty red Worker ships and some even nastier blue Warrior ships. Their job is to collect crystals from the planetoids with which to build a Deathstar, an unsightly object which will try to annihilate you. Your job is to collect the same crystals to make Starbombs, which are your only defence against the Deathstar. You mine crystals by blasting the planetoids with a laser, which also comes in handy for blasting Workers and Warriors.

That's about all there is to it, rotating and blasting. Doesn't sound like much fun, does it? But it is. For one thing, everything happens pretty fast, and it's a real white-knuckle job keeping your little ship under control and firing your laser. For another thing, there's a constant tactical problem to resolve.

The mode 5 graphics are as elegant as they need to be, and the animation is as zippy as the sound is zappy. Although there's nothing surprising or revolutionary about *Deathstar*,

it's a neat demonstration that an old formula, when cleverly handled, can still produce a thoroughly enjoyable game.

Jeffery Pike

KNOCKOUT IT'S NOT



'Tennis', Bug-byte, BBC B/B+/Master/Electron, £2.99 (cassette only). Version reviewed: Electron

As a tennis fan I was delighted to receive this game but soon discovered that, despite its success in the software charts, this was a case where low price meant low quality.

The inlay card promises five opponents of reputedly increasing skill, but I haven't yet seen anyone get past the first round opponent, Manual Fawly. Your viewpoint is from behind your own player who's controlled with four directional keys plus Space to hit the ball.

In theory the game sounds promising – all the expected facilities seem to be here: a ball boy to collect stray shots (always mine), a giant electronic scoreboard, sound and 3D graphics. However, this is the kind of program which gives budget games a bad name – the graphics are crude and unconvincing mode 5 chunks, there's no two player option, the use of sound is indescribably poor, and, worst of all, the response from the keyboard is pathetic.

Maybe, I thought, things would get better with practice. And here *Tennis* proved its complete lack of potential – the game is not only utterly boring, it's also so difficult, in both Electron and BBC versions, that I didn't manage to win a single game.

By then I think even the micro had had enough. I certainly had.

Bernard Emblem

UNINSPIRED POND LIFE



'Savage Pond', Bug-Byte, BBC B and Electron, £2.99 (cassette). Version reviewed: BBC B

Savage Pond is a poor attempt at making something out of nothing. The game is really a simple arcade game that involves you in little more than whizzing around the screen trying to avoid some blobs and hit others.

The scenario is anything but simple and explained very badly in the cassette sleeve notes. You are a tadpole. Not surprisingly you are very pro-frog. The idea is to build up a colony of frogs in the local pond.

It's all very educational. You have to eat worms and amoeba and avoid the stinging hydra and the dragonfly nymphs. Dragonflies doing flypasts drop eggs which you must knock off before they hatch and other equally fascinating events occur in the busy life of the pond. Even mankind gets a look-in by dumping radioactive waste.

It is true that the screen display in this game is very pretty (though rather reminiscent of a David Bellamy programme) and the movement of all the various characters is smooth and responsive to the control of both joystick and keyboard. The colours are vibrant, the characters well designed, and so on. However, the game itself is totally uninspiring.

Bug-Byte was a big name in games software about two years ago – and not just for the BBC micro market. The name died out but has been resurrected by Argus Software. If *Savage Pond* is a typical example of the kind of material behind the comeback I suspect we shall not be hearing much more from them.

Geoff Bains

SPEEDYSOFT

024 026 3703

ALL ORDERS NORMALLY DESPATCHED
THE SAME DAY WE RECEIVE THEM

AMX MOUSE

"A LOVELY LITTLE CREATURE." (Crash!)

"The AMX mouse represents excellent value for money ... the obvious choice for everyone interested in graphics ... what more could you want?" (Popular Computing Weekly 04/86) BBC/BBC+. 16K ROM + 40/80 Track Disc. £5 off. Only £84.95

GRAPHIC ADVENTURE CREATOR.

WRITE AND SELL YOUR OWN ADVENTURES.

"The most astounding program I've ever encountered on an eight-bit machine ... those who want to write adventures will find there is no better value-for-money product on the market." (Amix 12/85)

BBC. Cassette £22.95 Disc (State 40 or 80 Track) £27.95

1986 HACKER'S HANDBOOK

"An extremely useful handbook for anyone with a modem who wishes to explore a bit further than the pages of Micronet." (Sinclair User)

New 168-page paperback of 1985 best-seller is expanded and updated.

BBC/BBC+/BBC Master. Paperback £6.95

IMAGIN.A

"The first piece of graphics software to take full advantage of the extra memory in the Master and BBC+ ... a fast and sophisticated drawing package." (A&B Computing 06/86)

BBC/BBC+/BBC Master. (Ibbotsons) State 40 or 80 Track disc: £57.50

"THE FASTEST SOFTWARE SERVICE IN THE WORLD"
(P. SZETO, WALES)

PHANTOM

"Response to the controls is fabulous ... if you like flying, this game is for you ... the best flight simulation I've seen on the Beeb." (Micro User 03/86)

'Phantom' is a great flight/combat simulator. 'DOUBLE PHANTOM' is the world's first multi-user combat simulation. Each BBC (hardware link supplied for 2) becomes a separate fighter, sharing the same airspace!

BBC/BBC+/BBC Master. (Dr Soft) Cassette £9.95. Disc (State 40 or 80 Track) £12.95. DOUBLE PHANTOM (40/80 track OK) £19.95

THE QUILL

"A superb utility ... it overcomes most of the memory limitations imposed by programming in BASIC and must be an absolute godsend to people who have the imagination, but not the programming ability, for creating adventures." (Computing with Amstrad 11/85)

BBC/BBC+/BBC Master. (Gilssoft) Cassette £16.95 40/80 Track disc £22.95

COMMANDO

"Sticks closely to the arcade game and has great music ... GI Joe is beautifully animated ... totally addictive arcade copy." (C&VG 02/86)

BBC. (Elite) Cassette £9.95 Disc (State 40/80 Track) £14.95

"EXTREMELY FAST AND RELIABLE SERVICE"
(P. TURNBULL, NEW ZEALAND)

FLEET STREET EDITOR

"The supplied graphics, the ease with which layouts can be put together and the ease with which effects can be applied to text, mean that this is a true step-up from the wordprocessor in combination with conventional artwork ... an all-round success." (A&B Computing 03/86)

BBC. (NOT with 6502) (Mirrorsoft) 2 discs (State 40/80 Track) £39.95

MINI OFFICE 2

"It's excellent ... the word processor is literally overflowing with excellent features ... the database is very easy to use yet extremely powerful ... the spreadsheet is the next little gem ... I cannot praise it too highly." (Popular Computing Weekly 03/86)

BBC/BBC+. (Database) Cassette £14.95. Disc (State 40/80 Track) £16.95.

YES CHANCELLOR

RUN THE COUNTRY BETTER THAN THE CHANCELLOR.

This complex simulation comes with threatened strikes, runs on the £, elections, opinion polls. Use the on-screen graphs to help you decide. Survive for 15 years and you'll have earned yourself life peerage!

BBC/BBC+. (Chalksoft) Disc only (State 40/80 Track) £17.50

CITADEL

100-SCREEN ARCADE ADVENTURE

"The ultimate arcade adventure for BBC owners ... impressive full-colour graphics and perfectly smooth scrolling." (Popular Comp: Weekly 04/86)

BBC. (Superior) Cassette £9.95 Disc (State 40/80 Track) £11.95

HOW TO ORDER

UK prices include VAT. Export prices are the same, because of the extra work involved. Remember to add postage and packing: UK £1 per order; Europe £1.50 per program; Outside Europe £2.00 per program. Satisfied customers in 64 countries. To order quote reference 'ACU18'.
BY PHONE: Call 024 026 3703 at any time, 24 hrs a day. Leave your name, address, phone no., order, credit card type, expiry date, card number, quote reference 'ACU18'.
BY POST: Send your order to SPEEDYSOFT, The Blacksmith's, Radnage Common, Bucks HP14 4DH. Make cheque/PO payable to Speedyssoft. Don't forget to add p&p. Quote reference 'ACU18'. All orders must be prepaid.

0664 63617

Squirrel's Byte



Ribbons

Shinwa	3.45	Epson FX/RX/MX80	3.15
Kaga KP810	4.35	Epson FX/RX 100	4.52
Canon PW1080a	4.35	Epson LX80	3.39
Juki 6100 S/S	1.45	Seikosha GP80/100/250	3.20
Brother HR15	3.00	Walters WM2000	3.85

Many other ribbons available - please ring
Printer cables 1.5 metre 6.75 2 metre 7.75

PAPER & LABELS

1000 sheets per box		Price per 1000 labels	
Exact A4 70gsm	16.75	3.5" x 1.5" 2 across	5.99
11 x 9.5" 60 gsm	12.95	2.75" x 1.5" 2 across	5.39
12 x 9.25" 60 gsm	14.95	2.75" x 1.5" 3 across	5.39

DISKETTES

Prices per box of 10

100% guaranteed	5.25"	VERBATIM DATALIFE
SS DD 48tpi	7.95	13.95
DS DD 48tpi	8.95	17.95
SS DD 96tpi	11.95	18.95
DS DD 96tpi	13.95	22.95

DISK STORAGE
SEE-10 (10 x 5.25") 1.75 Lockable box (70 x 5.25") 10.95

DISK DRIVE SERVICING/REPAIR

Rates for service/recalibration and minor repairs Inclusive of VAT and return P&P:
single drives £25, dual drives £30.

ALL PRICES INCLUDE CARRIAGE BUT NOT VAT.
Please telephone if you do not see the item you require.

Squirrel's Byte
252 Scafford Road, Melton Mowbray,
Leicestershire, LE13 1LA. Tel: (0664) 63617

AA284

DOUBLE PHANTOM?

YES! This IS the program demonstrated on BBC TV's "Micro Live". The Worlds first micro multi-user combat flight simulation is now available direct from DOCTOR SOFT via our 'HOT LINE' FIRST CLASS MAIL ORDER service.

DOUBLE PHANTOM is basically a TWO computer version of the highly acclaimed PHANTOM COMBAT simulation. At least one BBC must have a disc system. A hardware link (included) then links the machines which become separate aircraft sharing the same airspace, each VISIBLE and VULNERABLE to the other!

DOUBLE PHANTOM has all the usual PHANTOM features including the fastest and smoothest 3D colour graphics around (15fps). RAF Phantom pilot Paul Courtneage's verdict: "Marvellous ... quite the best micro flight simulation I've ever seen ... Totally captivating!"

Phone: Mail Order Hot line 0903 776000 with VISA/ACCESS. Mail: PO BOX 66, East Preston, West Sussex BN16 2TX. Most orders despatched SAME DAY, FIRST CLASS, POST FREE.

DOUBLE PHANTOM (inc link)	BBC ★	disc 19.95
LINK separately	BBC	cable 9.95
PHANTOM COMBAT	BBC ★	disc 12.95
PHANTOM COMBAT	Electron & BBC	cass 9.95
747	BBC B only	disc 9.95
747	BBC B only	cass 8.95
747	Electron	cass 7.95
747	Commodore 64	disc 12.95
747	Commodore 64	disc 14.95
747	Commodore 64(USA format)	disc 14.95

(Overseas orders, equiv currency, add air mail at cost)
JOYSTICKS optional with all programs
BBC means all machines from 32k up
★ SPECIFY DFS when ordering discs
£2 discount on multiple order

DOCTOR SOFT - THE FLIGHT SIMULATION
SPECIALIST

ACCESS
VISA
EUROCARD
MASTERCARD



REVIEWS

SOFTWARE

RECOMMENDED ADVENTURE

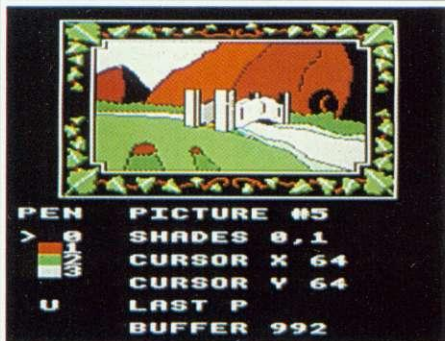

'The Graphic Adventure Creator', Incentive Software, BBC B and B+, £22.95 (cassette), £27.95 (disc). Version reviewed: BBC B

Ever felt you had a great idea for an adventure but were put off by the programming? Incentive Software has come up with the answer by producing – in effect – a programming language specifically for adventures.

That's perhaps overstating it a little. What the program does is to allow you to build up the substance of an adventure – the commands, the descriptions, objects and events, while taking care of the nitty-gritty.

The software handles things like the language parser – which makes sense of what the player types in. It also allows you to build up the plan of the adventure very easily. Creating a room is a simple matter of giving it a number, writing a description and then saying what exits there are.

You can also assign a screen display to each room. These are created with a simple artist program and stored in a separate file. You also give the system a list of words, including verbs, adverbs, nouns, objects and so on. Then comes the clever part. You can write rules associated with the words, the objects and the room, so that quite complex interactions can be built up. The method of creating the rules is faintly reminiscent of Prolog.

Tricky things, such as routines to save and load the current game position, and linking rooms and objects, are all handled by the system. At any time you can save the adventure to disc or tape so that you can resume work on it later. And when the game is finished it is saved as a stand-alone file, which is started by typing *RUN <filename>.

There are many sophisticated features to this program. The important thing, however, is that it frees adventure writers from the drudg-

ery of coding and allows them to concentrate on the imaginative and creative side of the process. Highly recommended.

Steve Mansfield

FIVE-MINUTE WONDER



'Winter Olympics', Tynesoft, BBC B and Electron, £7.95 (cassette), £11.95 (disc). Version reviewed: BBC B

I was looking forward to this game, eagerly anticipating the stunning scenery of the Alps and the terrifying thrills of some of the fastest sports on Earth.

Sadly, it didn't happen. The scenery is virtually non-existent, with just one recognisable mountain throughout the whole of the five events.

As for the thrills – well, the games do get fast sometimes. But the graphics are too jerky and awkward to make you feel you're ever really in control.

The first event is speed skating. If you're playing by yourself, ignore your opponent as he's just there for decoration (if you can call the simple graphics decorative).

Next up is the ski jump. The action is thankfully short-lived here, but at least the mountain in the background is pretty. The next event is the ski slalom, where you have to aim between the flags. Then comes the downhill ski-ing, which is more of the same but without the flags and with a few more trees.

You're now on the Cresta Run. Two graphics are used here – a small and crude 3D window on the run, and a map showing your progress. Again the graphics are jerky and, when you crash, positively ridiculous.

For me, there was a five-minute wonder. I was amused the first time through, but quickly got bored. And the constant reloading of events was a real pain.

Steve Mansfield

HAPPY EVER AFTER



'Jack Attac', Bug-Byte, BBC B and Electron, £2.99 (cassette). Version reviewed: BBC B

The Jack of the title is he of beanstalk fame. As Jack, you have to run around the beanstalk and the giant's castle to rescue your sweetheart, Jill (a sad case of mixed-up nursery rhymes, this). Now, I tell you all this because you'd never guess it from the screen picture.

Plot aside (and who can seriously say they buy a computer game for the plot?) *Jack Attac* is fun enough. It's fairly standard stuff. There is a seemingly endless supply of screens, all interconnected and filled with an assortment of ladders and platforms and the odd nasty. Jack must trot around these searching for Jill. Of course, some parts of this maze of bean foliage are blocked from Jack's path by locked doors and so Jack must find the keys for these first.

Once the final key is found the giant wakes up and Jack must rescue Jill, escape from the castle and climb down the beanstalk all in two minutes, before he can get down to the serious matter of living happily ever after.

So, let's face it, there's nothing very new here. However, it works. There is a strange addictive quality about games like this. The movement of Jack and the few moving baddies which infest the beanstalk is very slick and the controls nice and responsive. It's true that the whole game did crash once, insisting on drawing every screen on top of another (not a pretty sight) but that all adds to the excitement.

Jack Attac's standard of presentation is laughable. There are mistakes on the cassette sleeve and in the game's opening pages and Bug-Byte can't seem to decide if it's 'Attac' or 'Attack'. I can't give full marks for a game with these kind of errors and such a lack of originality, but it's cheap and fun to play.

Geoff Bains

POOLS CHEQUE
DON'T MISS YOUR WINNINGS
A LITTLE GEM



Ideal for any pools entrants, syndicates or Litplan users. As many copies of printout as required. Stores your lines or perms, once results are known enter results and the computer automatically prints out your highest score. BBC B & MASTER (DISC).

ONLY £12.50
INC VAT

Also available

EASY BANKER £8.50 as previously advertised.

Builders/Architects/Surveyors/Educational
"All-in-rate" Calculator £15 + VAT.

Electronic Price Book

(V1) £45 + VAT, (V2) Extended £95 + VAT.

Pocket Engineer (Beam stress calculator) £30 + VAT. Disc or TAPE.

Central Heating Calculator £45 + VAT.

Electrical Cable Selector £45 + VAT.

Bespoke Programming/Conversion work - Write/Ring for information.

COMING SOON - ESTIMATOR £125 + VAT.

Or £200 + VAT (including Price book version 2).

From

ROOM 7 SOFTWARE

Discounts available on multiple orders.
All prices inclusive of postage & packing.
Trade discounts negotiable.
All programs run on BBC B & Master



Letters/cheques to: **W.L. Computer Services, Dept 2, First Floor, H.S.L. Buildings, 437 Warrington Road, Rainhill L35 4LL**
Orders using Barclaycard/Visa tel: 051 426 9660



AA282



STOCK CONTROL, INVOICING & DESPATCH

S.I.D

£69 VAT
r.r.p. £95

No other program gives so much at this price

- Stock Control** **DRIVEN FROM ONE MAIN MENU**
- * each stock record contains details of the following: name, current stock held, minimum stock, last qty received, last qty issued, supplier, price, date last issued, date last received, goods received note no., vatiable, back order, cost of back order, minimum re-order qty, total sales, total purchases for period
 - * maximum of 500 stock records
 - * no need to swap files or save stock file for different functions
 - * comprehensive manual, user friendly
 - * options available to add, amend, list, inquire, print, update issues and update individual receipts
 - * summary of items below re-order level
 - * financial summary, giving sales/purchases for each item if desired
 - * 2 types of stock items: goods or sundries
- Invoicing**
- * order processing made simple through one easy routine
 - * orders can be entered, reviewed, changed, deleted and then processed
 - * 2 types of invoices created
 - summary only on invoice
 - each stock item ordered listed on invoice with prices and quantities
 - * statements produced
 - * all ordered stock items taken away from stock
 - * invoices/statements printed on plain paper with your name, address and vat number on top. Then the client name and delivery address followed by invoice details and then the foot message
 - * foot message can be modified
 - * auto increment of invoice number (also option available to set invoice number)
 - * items out of stock are marked as "back order" on invoice and not charged
- Despatch**
- * identifies goods/sundries to be despatched
 - * reference number printed on despatch note
 - * will identify back order goods

MINIMUM HARDWARE REQUIREMENTS ◆ **BBC B DFS., 80 trk DD DISK DRIVE, EPSON COMPATIBLE PRINTER, MONITOR** ◆

★ **Make Money** ★
Use your Beeb to make your Profits
Send for details

DEALER ENQUIRIES WELCOME
Send for details

ALL ORDERS BY POST ONLY



Your name, address, telephone number and vat number if applicable must be supplied as this is incorporated on your disk. (For invoicing part of programme and security).
All Access orders must be signed with card number and expiry date and address of card holder supplied, cheque P/O made payable to "RAB SOFTWARE" for £79.35.

Send to **RAB Software 5 Maryfield Park, Mid Calder, W. Lothian EH54 0SD. Tel: 0506 882313**

AA241

BBC Basic, the POWERFUL Control Language making control of our extensive range of Eurocards easy, speedy, and precise. CMS puts YOU in control.

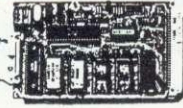
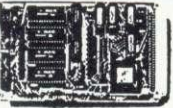
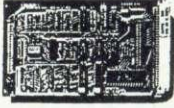
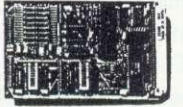
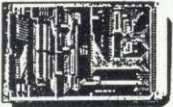
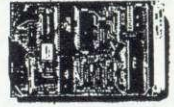
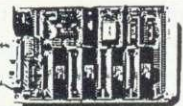
Add Multi-Basic and you have a very POWERFUL Real Time Control System.
We have satisfied customers in the following areas:

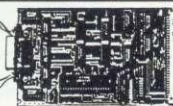
 6502 PROCESSOR	Batch Processing	 ADVANCED GRAPHICS	Alarm Systems and Monitoring	 DISC STORAGE	Custom Design Service
 ANALOGUE/DIGITAL	Plant Mimics in Full Colour	 POWER INTERFACE	Automatic Test Systems	 40/80 COLOUR VIDEO	P.L.C. Networking
 VERSATILE INTERFACE	Plant Monitoring	 SERIAL INTERFACES	P.L.C. Graphic Systems	<ul style="list-style-type: none"> • All Boards in Stock at All Times • Top Rate After Sales Service • OEM and Education Discounts • Software Support • Custom Engineering • Fully Guaranteed 	
 GRAPHICS DISPLAY	Industrial Networking MAP/LAN	 IEEE INTERFACE	Energy Management		

BMS Cambridge Microprocessor Systems Limited
44a Hobson Street, Cambridge CB1 1NL
Telephone 0223-324141

REVIEWS

SOFTWARE

INDEX YOUR VIEW TEXT

FJ
bold text		13
creation of an index		1
double highlight 1 codes	6,13	
EDIT		3
Extended highlight sequences		12
filenames		4
final index		11
Highlight 1 codes	8,9	
index entries	1,8	
index entries in text files		6
intermediate index		1
intermediate index file	1,4	
Length of index entries		11
Maximum index entry length		12
output format		11
page number		1
practical maximum length		11
Preparing the document text		3
printer drivers		15
text files		1
unbroken sequences of highlight codes		15
underlining		8
VIEW text file		1
ViewIndex printer driver		1

'ViewIndex', Acornsoft, BBC B/B+/Master, £14.95 (disc)

ViewIndex is a comprehensive program which allows authors of large documents to create an index more quickly than by the usual, manual, methods. This disc-based package creates an index either by page numbers or section numbers (in the form 1.5.2).

To allow *ViewIndex* to recognise the words or phrases it will include, a double HIGHLIGHT 1 is used to mark each string in turn. Strings may be up to 50 characters long. Only marked entries are included in the list, all other occurrences of the string are ignored. It is worth mentioning that it is prudent to enter the index highlights as the text is being created. I used a very long document to test the package's capabilities and it was tedious to enter the markers – though still more efficient than doing it all manually. However, if word-marking is part of the writing process it becomes far simpler. One further point: *ViewIndex* is not intelligent so any strings which contain punctuation marks will be listed complete with incumbent punctuation. Similarly, if the text contains several references to the same point, each worded slightly differently, these will be in different parts of the index.

ViewIndex contains two template files: one for index by page numbers and one for index by section numbers. By loading the *ViewIndex* printer driver (PRINTER INDEX), and asking it to 'print' all the document files, an intermediate index file is created. Once the file

is built it is then read, sorted, multiple entries merged and the whole thing written out to a final index *View* file. The *ViewIndex* sort file also contains options for formatting and presenting the final layout of the index. Creating a page number index is very simple indeed. The section number index requires a macro to be called at the start of each chapter, section and sub-section.

Apart from the lengthy marking process, the creation of an index takes remarkably little time. Once the text was marked, it took about five minutes to create a four-page index from a 30-page document. In addition to being very quick *ViewIndex* is a very 'user-friendly' package. The accompanying 22-page manual is a model of clarity (part of it appears on the disc as a text file to help you get to grips with the package). In no time at all I became proficient and confident with the program.

ViewIndex is excellent, and it is a very valuable addition to the *View* suite of integrated software. Acornsoft has produced a totally professional piece of software.

Chris Drage

KEEP TRACK OF YOUR FILES

'Discdex', Clares, BBC B/B+/Master, £15 (disc)

Discdex is a versatile disc-indexing and cataloguing system which enables the user to keep track of programs and other files. It acts as a database in that it's possible to search through the records of your disc catalogue for given filenames and the end result will be printed complete with disc number, side and directory. Moreover, there is a utility for printing disc labels which may be done in a variety of print sizes, bearing in mind that 32 files on one label will be cramped.

The operation of the program is almost totally automatic. All the user needs to do is to feed the discs into the drive and press the space bar. The catalogue is retained in memory and then committed to disc when the data collection is finished.

The results of this information gathering may then be presented in a number of forms. For example, the user may need an alphabetic index to all files in the collection for a disc-by-disc index of what is contained on the surfaces. The various files may be split into sub-indexes so that games could be in catalogue G and

word-processing files in catalogue W. Disc numbering labels are provided as well as address-type labels on to which you can print out the disc information.

I found that not only was this program exceptionally easy to use but also that it gave me a facility I had never thought about before. The Evans collection of discs has never been so well ordered and, what's more, as the collection grows I shall be able to update my index by editing the index file.

All in all an excellent utility which will save people many headaches. Well done, Clares!

Nick Evans

PARLEZ FRANÇAIS AVEC LE MICRO

'Granville – the Prize Holiday Package', Cambridge Micro Software, BBC B/B+/Master, £28.70 (disc)

This is a French teaching package, consisting of a manual that looks more like a holiday brochure than a school text, book, and a disc packed with exciting situations in which learners can practise their French.

The idea is disarmingly simple. You have won a five-day trip to the seaside town of Granville in Normandy and can visit restaurants, museums, shops and other places of interest. You may ask for souvenirs and provisions in the relevant shops, select activities and modes of transport and answer quiz-type questions. There is a useful diary print-out routine which produces hard copy of the details of your travels and thus a never-ending source of material for conversation groups. The aim is to start you talking and thinking about your holiday in French.

The dreaded error message 'No room' has been known to come up during run-time, ruining an otherwise marvellous excursion and corrupting the diary file in the process. The program is written in some 20 Basic files which are constantly loading into each other, so that the disc drive never stops whirring, and one variable too many will apparently cause an overload. (This may occur even on the 64k BBC+, as *Granville* does not automatically select Shadow modes or contain the appropriate error-trapping procedures.) One must hope that this will be rectified in later editions. It is a pity that a first-rate program should be vitiated by a thoroughly familiar technical problem.

Osman Durrani

MICRO FIX

**FAST REPAIRS FOR THE
BBC MICRO BY
THE ACORN APPROVED
SERVICE CENTRE**
191 FRESTON ROAD, LONDON W10 6TH
PHONE: 01-968 9214

- Repair centre for BBC B, B+, Electron, disc drives etc.
- We have been Acorn service specialists for 3 years and are justifiably recognised as experts in this field.
- BBC micro repairs: average cost £15-£20.
- Complete disc drive calibration: £15/drive.
- Upgrades: Disc - £65 inc. installation.
Econet - £65 inc. installation.
- Other upgrades carried out as required.
- All repairs fully guaranteed.
- Insured return carriage if required.
- Extended warranties available on most equipment.
- Low prices for Mitsubishi disc drives and Acorn peripherals.
- Acorn authorised Econet support centre. Expert installations and trouble-shooting.
- Express service by prior arrangement.
- Opening hours: Normally Mon, Tues 9.30am-6pm, Weds-Fri 10am-4.30, but phone first.

RING 01-968 9214 AND ASK FOR MARK DUFFILL

AA82A

CHALKSOFT * GARLAND * STORM * CAMBRIDGE * H&H * GOLEM

Looking for the RIGHT Software?

You need the newly published 72 page

EDUCATIONAL SOFTWARE DIRECTORY

- * Widest selection of programs — over 500 for the BBC and other computers
- * Full program descriptions with screen shots
- * Easy ordering and competitive prices

Write or phone for your free copy today



Rickitt Educational Media

Ilton • Ilminster • Somerset TA19 9HS • (04605) 5152

AA58

AKADIMIAS * FERNLEAF * BOURNE * SCISOFT * JACARANDA * SULIS

BBC PUBLICATIONS * SHERSTON * ANIMATION

SELECTIVE * MACMILLAN * ASK * CLOU D 9

EPROMS * RAMS * DISKS

Lowest Prices/Fastest Delivery/Quality chips for the BBC
Prices **INCLUDE** VAT and UK post, normally by return

NEC 2764C once only progr. 2-5 pcs £1.75, 6+ pcs £1.45

2764 1-2 pcs £2.50, 3-9 pcs £2.25, 10+ pcs £2.15

Hitachi 2764 1-2 pcs £2.95, 3-9 pcs £2.55, 10+ pcs £2.40

27128 1-2 pcs £2.90, 3-9 pcs £2.70, 10+ pcs £2.50

Hitachi 27128 1-2 pcs £3.35, 3-9 pcs £2.95, 10+ pcs £2.70

Hitachi 27256 1-2 pcs £5.25, 3-9 pcs £5.00, 10+ pcs £4.30

Hitachi 6264LP15 (ATPL, Watford etc) 1-9 pcs £3.40, 10+ pcs £2.90

41254/41464-15 (upgrading Solidisk) £7.00 each

41416/48416 (upgrading Watford) £2.95 each

41256 1-2 pcs £3.30, 3-7 pcs £3.00, 8+ pcs £2.75

DISKS DS/DD 96 TPI. Hub-ring/Sleeve. Box of 10 £8.95

Send UK cheques/PO
LA or Gov't Orders to:

SILICON CITY

Mithian, St. Agnes, Cornwall TR5 0QE

Access/Visa orders, telephone 087 255 2112

AA268

FREE
RACING
ANALYSER

POOLS

PREDICTOR

17,000
MATCH
DATABASE

If you've ever asked yourself (and who hasn't!) how your computer can help you on your way to a pools fortune, here's some good news. The Mayday Software Pools Predictor. It's the expert system that's powerful and sophisticated yet easy to use. It comes with a massive database and, just as important, a track record of four highly successful seasons to back it up. So you can be confident you have your personal expert tipster taking the chance out of filling in your coupon. And completing this super punters' package, a free Racing Analyser program that will give you the low down on any horse race — without fuss!

1986/87 version now available for BBC, Electron and Spectrum (please state your computer when ordering).

AA283

MAYDAY
SOFTWARE

181 Portland Crescent
Stanmore, Middx. HA7 1LR

£11.99

ALPHA DISC LTD SUPERB QUALITY 40/80 TRACK SWITCHABLE DRIVES

ALSO AVAILABLE LIMITED STOCKS
OF LOW COST DISC DRIVES FROM £50.00

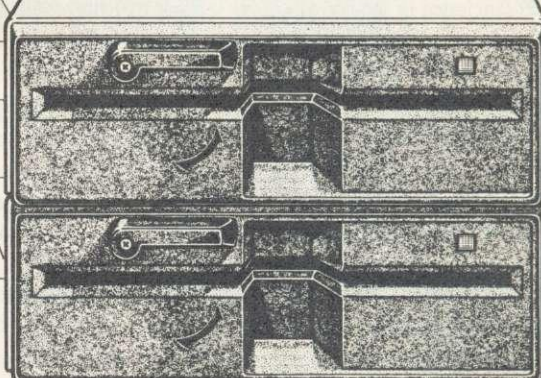
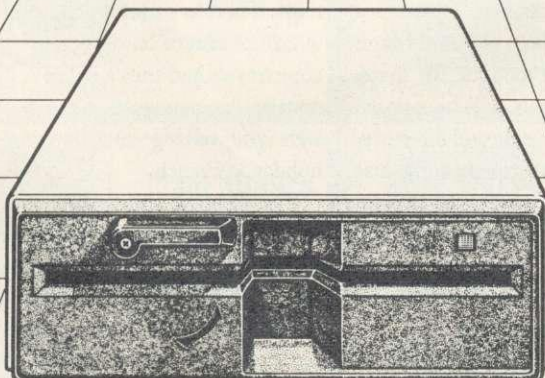

SINGLE WITH P.S.U. £169.00 - SINGLE WITHOUT P.S.U. £145.00 - DUAL WITH P.S.U. £295.00

UTILITIES
DISCUS — £7.00 COPYCAT — £12.00

ALL PRICES INCLUDE VAT AND DELIVERY



ALPHA DISC LTD, Unit 2, Crabtree Road, Thorpe Industrial Estate, Egham, Surrey TW20 8RN.
Tel: 0784 3535/7/8/9 Telex: 918886 ALPHA G



REVIEWS

SOFTWARE

MAKING CONNECTIONS

Geoff Bains experiments with electronic circuits on screen

A major problem with the teaching of electronics is that practicals tend to become bogged down in the complexities of interconnecting components rather than with the real business of what is going on. Transistors are fiddly to connect up in the complexity that is needed to do anything useful and integrated circuits confuse pupils with their layout of inputs and outputs – they're so different from the easily remembered block diagram found in the text books.

There are ways of getting around this

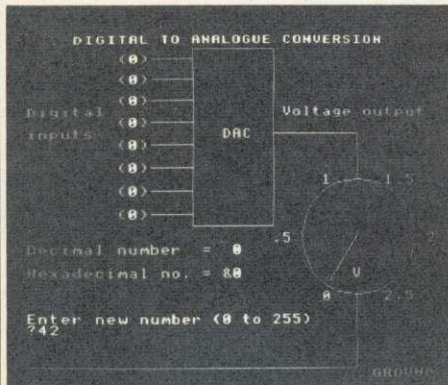

Enter your digits . . watch the voltmeter

problem. Griffin and George's *Digital Units* put the uninviting components away inside little boxes which connect together in the same way as a block diagram. However, there still remains the problem of expense and time spent setting up a complicated piece of apparatus to demonstrate a simple point.

Addison-Wesley's *Digital Electronics* course aims to teach electronics without any of these problems by using computer-simulated experiments on the micro.

The course is aimed at secondary school level and at ITECs and further education colleges. It is very much biased towards modern electronics and computers and is in three units – Coding Information, Digital Systems and Microprocessor Systems. Each unit comprises a student's booklet and 40-track disc containing the experiment simulations. The first unit costs £14.95, the other two £19.95, and a complete pack of all three £49.95 (all excluding VAT). All three units are eligible for DTI support.

The unit looked at here is the first of the course – Coding Information. This is designed to introduce students to the idea of digital data

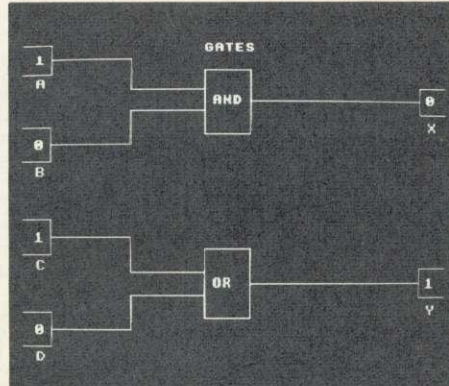

A classic benchtop circuit on the micro

and the fact that computers are just a means of processing on-off binary signals.

The unit booklet is about 20 pages long and both teaches and tests students. It is split into six sections which cover the nature of digital data, digital representation of analogue information, logic gates, digital arithmetic, computer (ie, ASCII) codes, and simple computer control language.

Each section is riddled with simple questions to test that what has just been taught has really sunk in. The answers to the questions are given at the back of the booklet – perhaps a dubious advantage.

Dotted around the booklet are four computer-simulated experiments/demonstrations, which strikes me as too few. It is all very well restricting practical time to the minimum when half that time is 'wasted' on setting up and connecting together the apparatus, but when the whole point of the course is to restore some sense to experiments by undertaking them on the computer screen, it is surely more sensible to make the most of it and capture the students' imagination and interest with as many experiments as is reasonably possible. To include fewer than one per section seems to me ludicrously unambitious.

However, four experiments it is. The good news is that the programs are compatible with just about anything (Basic 1 and 2, and B+ and Master) although the last experiment has problems with active shadow RAM or second processor. The whole disc is unprotected, so allowing a backup or tape copy to be made.

The first experiment is one which would normally be a mind-boggling hassle to arrange 'for real' but on the micro is quick and easy.

This is a demonstration of digital to analogue conversion. The screen shows a block diagram circuit of DAC connected to a voltmeter. Numbers can be entered into the DAC and their effect on the meter watched. It's simple but effective.

Similarly the second experiment is a classic 'real' benchtop circuit transferred to the micro-computer. This demonstrates the AND and OR gate, using four keys on the Beeb's keyboard to supply the two input states to each gate. The result is then displayed on the block circuit diagram on the screen.

The third program demonstrates simple eight-bit addition, subtraction, and arithmetic shifting on a byte. Doing a demonstration such as this with real hardware would be bound to become far too involved with the circuit which makes it all possible, rather than concentrating on the result.

The fourth experiment is one which would be far too complex for construction in the laboratory, anyway. This program implements a simple Logo-like language to control a range

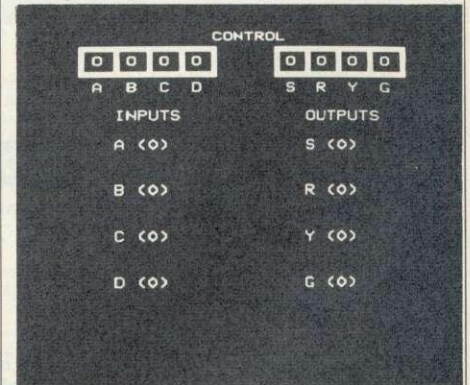

Eight-bit arithmetic made simple

of inputs and output on the screen. The language is simple, with only about 10 commands, but the ability to define new words makes it both fascinating and instructive.

It would be foolish to pretend that computer simulations can totally replace real-life experiments in any subject. However, the *Digital Electronics* course does demonstrate what can be done. It is only a pity that more experiments were not included.

Digital Electronics: Unit 1, £14.95; Units 2 and 3, £19.95 each; complete pack, £49.95 (all exc VAT)
Addison-Wesley, Finchampstead Road, Wokingham, Berks RG11 2NZ. Tel: (0734) 794000

PINEAPPLE SOFTWARE

Programs for the BBC models 'B' with disc drive with FREE updating service on all software

DIAGRAM

Still the only drawing program available for the BBC micro which gives you the ability to draw really large diagrams and scroll them smoothly around the screen stopping to edit them at any time if required.

Pineapple's unique method of storing the diagram information on disc means that the size of diagrams is limited only by the free space on disc, and not the amount of computer memory you have available. (A blank 80 track disc will allow up to 39 mode 0 screens of diagram).

The superb print routines supplied with the program enable large areas of the diagram to be printed in a single print run in a number of different sizes and rotated through 90 deg. if required. Full use can also be made of printers which have a wider than normal carriage available.

The program is fully compatible with the Marconi Tracker ball described below.

PLEASE STATE 40 or 80 TRACK DISC & WHETHER STANDARD BBC or MASTER VERSION IS REQUIRED

PRICE £25.00 + VAT

DIAGRAM UTILITIES

A suite of six utility programs which add additional features to the 'Diagram' drawing program. The utilities include the saving and loading of areas of diagram to and from disc. The ability to display the whole of your large diagram on the screen at one time (in either 4*4 or 8*8 screen format). The addition of borders and screen indents to diagrams, and the ability to shift a whole diagram in any direction.

PRICE £10.00 + VAT

MARCONI TRACKER BALL

This high quality device comes with it's own Icon Artmaster drawing program and utilities to enable it to be used in place of keyboard keys, joysticks, or with your own programs.

PRICE £60.00 + VAT p&p £1.75

PRICE INCLUDING 'DIAGRAM' SOFTWARE £79.00 + VAT p&p £1.75

TRACKER BALL for MASTER series

The Pointer ROM is supplied instead of the Icon Artmaster disc and enables the Tracker ball to work directly with the MASTER series computers. (e.g. to use with TIMPAINT etc.). Prices are the same as for the standard tracker ball.

POINTER

The Pointer Rom is available separately for people already owning tracker balls, and comes with instructions for use with the MASTER computer.

PRICE £12.50 + VAT

PCB

This new release from Pineapple is a printed circuit board draughting aid which is aimed at producing complex double sided PCB's very rapidly using a standard BBC micro and any FX compatible dot-matrix printer.

The program is supplied on EPROM and will run with any 32k BBC micro (including Master series). Also supplied is a disc containing a sample PCB layout to demonstrate the programs features.

By using an EPROM for the program code the maximum amount of RAM is available for storing component location and ASCII identification files etc. (Up to 500 components and 500 ASCII component descriptions may be stored for a given layout). These is no limit to the number of tracks for a given PCB, although the maximum size of board is restricted to 8" * 5.6".

Using a mode 1 screen, tracks on the top side of the board are shown in red, while those on the underside are blue. Each side of the board may be shown individually or superimposed. A component placement screen allows component outlines to be drawn for silk screen purposes and component numbers entered on this screen may be displayed during track routing to aid identification of roundels.

The print routines allow separate printouts of each side of the PCB in a very accurate expanded definition 1:1 scale, enabling direct contact printing to be used on resist covered copper clad board.

This program has too many superb features to describe adequately here, so please write or phone for more information and sample printouts.

PRICE £85.00 + VAT

CONVERTER LEADS

Converter leads to enable the Trackerball to run mouse software and the mouse to run trackerball software (inc. DIAGRAM). Please state which way round when ordering.

PRICE £8.00 + VAT

BASIC COMPILER

Use our Basic Compiler to produce direct 6502 machine code programs and ROMs for your own Basic programs. Speed increases of up to 25 times are achieved.

PRICE £25.00 + VAT

**ALL ORDERS SENT BY
RETURN OF POST**

39 Brownlea Gardens, Seven Kings, Ilford, Essex IG3 9NL. Tel: 01-599 1476

Educational Software NOW MASTER COMPATIBLE

LCL

MICRO FRENCH



For any BBC Micro, Electron (Tapes, 40/80 track discs Econet compatible) Commodore 64, ZX Spectrum, unexpanded Vic, ZX81, Apple, PET, Amstrad

IMMEDIATE DISPATCH

Send coupon, or phone orders or requests for free colour catalogue to: LCL (Dept A) Melody House, Greys Road, Henley, Oxon. (Tel: 0491 579345 or 0784 58771 (10am-10pm))

£5 off total for 2 courses,
£10 off for 3, £17 for 4

MICRO FRENCH (NEW) (BBC, Electron) 24 program self-tuition GCSE ('O'-level) course with real speech, prepares you for both oral and written exam. Intense but fun £24.

MICRO MATHS 24 program revision or self-tuition course taking beginners (from 8yrs) to O-level. (GCSE) Includes 59 topics on 2 discs/tapes plus two books (now has more colour graphics). £24.

MICRO ENGLISH (BBC, Electron, Amstrad). Complete English Language self-tuition and revision course, to O-level, (GCSE) of 24 programs. Includes "Speak-and-Spell" with real voice. £24.

MEGA MATHS (BBC, Electron, Amstrad). 24 program step by step. A-level course of 105 topics for mature beginners, A-level students and Micro Maths users (2 discs/tapes & 2 books). £24.

**WORLD LEADERS IN COMPLETE SELF-TUITION
COURSE SOFTWARE (IN 24 COUNTRIES)**

Excellent reviews

NAME ADDRESS

TITLE COMPUTER 40/80 Disc/tape

AA41

Micro Musician POLYPHONIC MUSIC PROCESSOR SYSTEM



A CASIO KEYBOARD INTERFACED TO THE BBC
PLUS A PROFESSIONAL 8PART MUSIC EDITOR ON DISC

For only £199 +VAT (MINI KEYBOARD) £249 +VAT (FULL SIZE KEYBOARD)

*Teaching *Performance *Composition *Music Printing *Traditional Notation
*Scrolling Colour Display *Parts Analysis *Many unique outstanding features

MICRO MUSICAL LTD

37 Wood Lane, Shilton, Coventry CV7 9LA. Telephone (0203) 616760

Statistics

OXSTAT Easy to use, comprehensive statistical analysis for scientific and research use. Full spreadsheet facilities for data entry. BBC with Torch 280 and other machines CPM/MS DOS/PC DOS incl. Amstrad. £113.85 incl. V.A.T.

STATSKIT: User friendly statistics package for BBC B + Master. Excellent graphics and most common routines. Data storage on disc. £49.00 incl. V.A.T.

ALSO: Genetics, time-related data analysis and Modern Languages from £12.95.

Send £3.00 for disc based catalogue. State 40/80.

Medstat Ltd

City House Maid Marian Way Nottingham NG1 6BH UK

24 hour telephone service 0602-411120

REVIEWS

SOFTWARE

MICRO MELODY MAKER

Jeffery Pike gets dots before the eyes with a new music package

There are numerous music packages around, on ROM, disc and tape, all designed to make the most of the Beeb's sophisticated four-channel sound facility. They all have their good points and their shortcomings. Some make inefficient use of memory and can only handle short tunes; others are cumbersome and difficult to operate; others demand either a well-developed musical imagination or a high degree of programming skill.

Writing tunes

It must be said straight away that *Musicpen* is of little use to anyone unfamiliar with reading and writing conventional music. If you can't read the dots, you won't know the score (geddit?). Entering the music editor from the menu, you first select a key signature (from a choice of nine – why not all 12?) and a time signature (2/4, 3/4, 4/4 or 6/8 – not comprehensive but adequate for most uses). It isn't possible to alter these within a piece of *Musicpen* music, so if you start in waltz time in the key of F, you're stuck with it throughout.

Then you're presented with a display of treble and bass staves waiting for your masterpiece to be written on to them (figure 1). Notes and rests are easily entered by a combination of function keys, cursor keys and the space bar, and appear on the staves as orthodox notes – well, nearly orthodox, for the note stems often stick up when they'd normally go down, and quavers and semiquavers are not joined by their tails where you'd expect them to be. A nice feature is the way that, as you enter notes, rests appear towards the end of each bar (bar-lines are drawn automatically), to let you know what note values are needed to fill it exactly. You can jump easily from one voice (channel) to another, so you can write one line at a time or fill in your counterpoint or harmony as you go along. The second or third voices dutifully appear at the right vertical position in the bar.

Musicpen is unique in its ability to accept data from a light pen. I have to confess that I don't own a light pen, so I was unable to try entering music by this means. But I tried the joystick option – and it didn't work. After configuring my joystick as instructed, I found I could jump forwards from bar to bar, but couldn't enter notes or move backwards. Let's hope that this is just a teething problem in the prototype. In

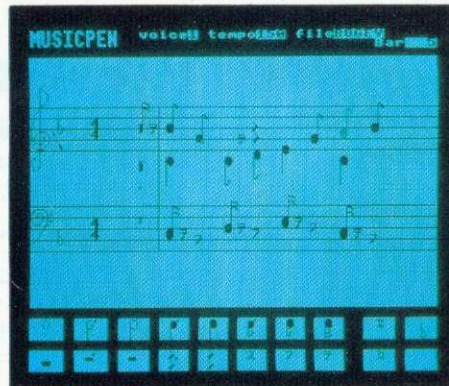

Figure 1. Notes and rests in the Editor

any case, keyboard entry is very straightforward when you get used to it.

Editing

When it comes to editing music, you can't jump to any point in the tune, only forwards or back to the adjacent note or the adjacent bar, or to the very beginning, or the very end. To make matters worse, auto-repeat is disabled for the cursor keys, so it can be a laborious process stepping bar-by-bar through a long piece. But once you get there, it's simple to alter the pitch or length of a note, or to delete it completely. And those useful rests pop up automatically to make everything 'fit'.

When you're entering or editing music, it's vital to be able to hear bits of it as you go along. The playback facility of *Musicpen*, like everything else about it, has its good and bad features. You don't need to start from the beginning: you can play back from wherever you left the cursor. You don't need to hear all channels at once: you can select any one, two or all three to listen to. On the minus side, you can't transpose the music up or down once it's written (as you can with some music software). More seriously, there's a very limited choice of tempo – only six options, ranging from not quite slow enough to not quite fast enough.

Envelope editor

Musicpen doesn't provide a set of predefined envelopes as some music programs do. You start with an even, characterless sine wave on all three channels, then use the envelope editor to create your own sounds. That's when the fun really starts. If you've had problems in the past unravelling the *User Guide's* explanation of

the Beeb's 14 envelope parameters... this won't help much.

You enter the envelope editor (quaintly called 'synthesizer') from the menu, to be confronted with a display that's trying to look like a graphic equaliser. The 13 sliders represent the parameters of the envelope command (without the first one, the envelope number) – but it's fiendishly difficult to relate them because they're displayed in a different order, with different names. If you've spent hours trying to memorise the parameters, it's distressing to find them laid out in a new sequence. It would help if the sliders at least had the same names – ALA, ALD, etc, instead of ATK TARGET, DCY TARGET, etc.

Once you've figured out which is which, it's easy to adjust each one with the cursor keys to form a new envelope. There's a play facility so you can hear how it sounds and a useful 'demo' feature which plays the sound repeatedly while you juggle the parameters.

But when you've constructed some mellifluous new envelopes, it's frustrating to discover that you're limited to a maximum of three, one for each channel. You simply can't edit a new one without losing (or saving) one of the three. It follows that your music can't draw on a library of envelopes, or change tone as it plays.

Incidentally, there is the possibility of using a fourth voice throughout, with the Beeb's notorious noise channel. But *Musicpen* is no more successful than anyone else has ever been at incorporating its limited range of squelches and hisses into euphonious music.

Other functions

A piece of music can be easily printed out on an Epson-compatible printer, and both tunes and envelopes can be saved and loaded from disc or tape. The 60-page manual goes into considerable detail on saving and loading files, stating all the obvious things that we should all know anyway. In fact, Sahlan Diver, the author of the software and the manual, seems to assume throughout that the user will have a fair degree of musical knowledge but a limited amount of computer experience. If that describes you, this could be the music-making software for you.

Musicpen, £28.75 (16kROM), by mail order from CNC, 41 Cheney Way, Chesterton, Cambridge CB4 1UE. Tel: (0223) 322244.

PARROT DISKETTES . BRITISH MADE

- 1) Superb Quality
- 2) Full Lifetime Guarantee
- 3) Plastic Library Case (SEE 10)



SUPPORT BRITISH INDUSTRY & EMPLOYMENT

- 5 1/4" S.S.S.D. @ £0.90 Each
- 5 1/4" S.S.D.D. @ £1.00 Each
- 5 1/4" D.S.D.D. @ £1.15 Each
- 5 1/4" S.S.Q.D. @ £1.25 Each
- 5 1/4" D.S.Q.D. @ £1.30 Each
- 3 1/2" S.S.Q.D. @ £2.15 Each
- 3 1/2" D.S.Q.D. @ £2.75 Each

Call Paul Lampard - National Sales Manager



3 Parklands Parade, Bath Road, Hounslow, Middlesex. Tel: 01-570 2529

BRITISH MADE PARROT DISKETTES

CLEANING PRODUCTS * STORAGE BOXES

IBM BRANDED PRODUCTS * LISTING PAPER * DATA CASSETTES

VERSATILE CAD/CAM

For the BBC Micro

A sophisticated, menu driven, user friendly CAD/CAM package with many facilities for very accurate drawing construction and data extraction for Numeric Control (NC) post processing.

CAD System (EDUCAD) - £80 (ex. vat)

- * geometric/schematic drawings
- * zoom, scale and units control
- * text/symbols, any size and angle
- * mirror and duplicate
- * generalised x-y plotter output
- * area properties

- * construction/modification
- * text/symbol font editor
- * intersects and tangents
- * rubber banding
- * graphics screen dump
- * revision/material info. editor

CAM System (EDUCNC) - £35 (ex. vat)

- * part geometry from EDUCAD
- * tool path animation

- * part profile definition
- * generalised NC post processor

Both packages have explicit input prompts and error messages. This together with over 80 pages of online HELP data makes these systems easy to use and easy to learn - an ideal way of introducing this new technology.

TO ORDER simply specify disk format requirements or to obtain further details contact:

**EDUSOFT, 15 Tamworth Business Centre,
Amber Close, Amington, Tamworth, Staffs B77 4DS**

AA270

CROSSWARE

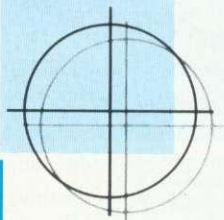

SOFTWARE DEVELOPMENT TOOLS FOR THE BBC MICROCOMPUTER

CROSS · ASSEMBLERS

FULLY SUPPORTED QUALITY SOFTWARE

Assemblers and Disassemblers on ROM

The BBC Microcomputer is an impressive machine, especially the new Master 128 running with the hierarchical Advanced Disc Filing System. Our software allows full use of its advanced facilities. For example, source code modules held in separate files of any name in any directory on any drive can be linked and assembled to create your machine code program in Motorola S, Intel hex or binary format.

It's also very fast. In fact, one of our customers has compared the speed of the BBC micro with Hewlett-Packard's powerful HP64000 development system. He assembled identical software on both machines and was surprised to find the BBC micro running with our 6801XR cross-assembler to be the fastest of the two.

Our software is available for assembling machine code programs for the BBC micro itself (for which our 65C02XR rom is ideally suited) or for any of the other target processors listed below. It is compatible with the models B, B+ and Master 128 and with all DFS, ADFS and Econet filing systems. (Owners of early model B's should ensure that their computer is equipped with Basic 2).

Order Code	Target Processors	Price
6801XR	6800,6801,6802,6301...6301X	£48.00
6805XR	6805,146805,6305	£48.00
6809XR	6809 family	£48.00
8085XR	8085,8080A	£48.00
Z80XR	Z80, HD64180	£48.00
68000XR	68000,68008	£56.00
65C02XR	65C02, 65SC02, 6502	£38.00

(prices exclude VAT)

Further information from:

CROSSWARE PRODUCTS

2 The Lawns, Melbourn, Royston, Herts SG8 6BA

Telephone: 0763 61539



Astronomy With Your Personal Computer

PETER DUFFETT-SMITH

For any amateur astronomer or computer enthusiast, this guide provides an invaluable collection of 26 sub-routines for use in astronomy, written in a portable version of BASIC, which can be varied and combined to cover most problems. The book gives all the details whilst the discs contain the programs from the book in an easily accessible form suitable for BBC(B) and IBM PC machines.

258 pp. 1985 0 521 26620 3 Hard covers £25.00 net
0 521 31976 5 Paperback £8.95 net
0 521 32144 1 BBC(B) Disc £12.50 incl. VAT in UK
0 521 32145 X IBM PC Disc £12.50 incl. VAT in UK

Fun Mathematics on Your Microcomputer

Software pack for Acorn Electron/BBC Micro

CZES KOSNIOWSKI

This package consists of a copy of the successful book of the same title together with two software cassettes. The cassettes contain versions of the programs in the book, specially adapted for the Acorn Electron and BBC Micro.

'... the book is a delight. It gives plenty of ideas for the general programmer as well as for the 'pure' mathematician.'

Computers in Schools

0 521 30119 X Software pack £11.50 incl. VAT in UK

For further details of all Cambridge Computer Science (and Astronomy!) titles, please write to Sally Seed at the address below.

Cambridge University Press

The Edinburgh Building, Shaftesbury Road, Cambridge CB2 2RU

DOCTRINA

EDUCATIONAL SOFTWARE

The Software that brings excitement to the Classroom.

Birdbase (as seen on BBC's "Nature Watch") gives lists and facts on all British birds; creates files; identifies individuals from your inputs.

Learn to spell: Help Cyril break the World High Wire record. Variable input, graphics, animation.

Lens: All the calculations you need to deal with convex and concave lenses, graphics + printout.

Chemo: Manipulate the Periodic Table to discover all about every element. Vivid graphics.

Maths I and II: Test your ability to calculate areas and volumes of solid objects.

Columna: Latin lives. Fast action game with sound and graphics, teaches basic noun inflections.

Ordo: Master the difficulties of Latin word order. The computer translates but you are the 'controller'.

Cassette £7.50 each; Disk £14.50 each.

Make cheques payable to: **DOCTRINA SOFTWARE**

WE PAY 20% ROYALTIES FOR EDUCATIONAL SOFTWARE

DOCTRINA SOFTWARE

**66 MANOR ABBEY ROAD
HALESOWEN, W. MIDS B62 0AB**

AA234

REVIEWS

HARDWARE

JOY FOR ELECTRON USERS

Mike Jackson reviews a new joystick interface and ROM board

Sidewinder is a semi-transparent box, 16cm by 9cm, providing Electron users with a unique combination of three facilities: it is an interface for a nine-pin switched joystick; it holds software in ROM which allows you to convert games to respond to the joystick; and finally (and quite differently), it is a ROM board with three spare sockets for your own firmware.

The unit fits directly on to the edge connector on the Electron. If you have a Plus 1 or 3, it must be detached and reconnected on to the far edge of the unit, which is claimed to be a full through bus connection. In this way, the Sidewinder will bridge the computer and the Plus interfaces. I could not test it with the Plus 3, but with the Plus 1 attached the system not only seemed ungainly, but was also insecure: it could quite easily be separated by a knock, even while powered-up. Otherwise, the Plus 1 seemed to work normally. I fitted a Spectravideo Quickshot II joystick to the Sidewinder and it seemed to work well.

The instructions for setting up are easy to follow. Simply type *JS ON and then reply to the short sequence of prompts – these tell the unit which keys are being used by your game for direction and fire. You are then told to load your game. Although in ROM, the software uses some RAM and a very long game may fail to run, with the equivalent of an 'out of room' message: *Repton 2* bit the dust here (I know, who needs joysticks for *Repton 2*?).

Wizard claim 99 per cent compatibility with Electron software. They claim to have tested the Sidewinder on software from a number of the leading software houses – I, though, only have a very limited selection. Well, the good news is that *Strike Force Harrier* is finally brought to heel. At last I could use my Quickshot II to fly with unequalled ecstasy into the side of every mountain on the map. It made it a different game and *Harrier* freaks may find it the answer to their dreams.

But will it liberate Electron *Elite* players from the keyboard, and enable them to blast their way beyond 'Rubbish' status? The answer, sadly, is no: the game loads and runs and you can still use the keys as normal, but it does not respond to the joystick.

Wizard believe that this may be due to lack of memory but are hoping to get their programmer working on an answer. So you're

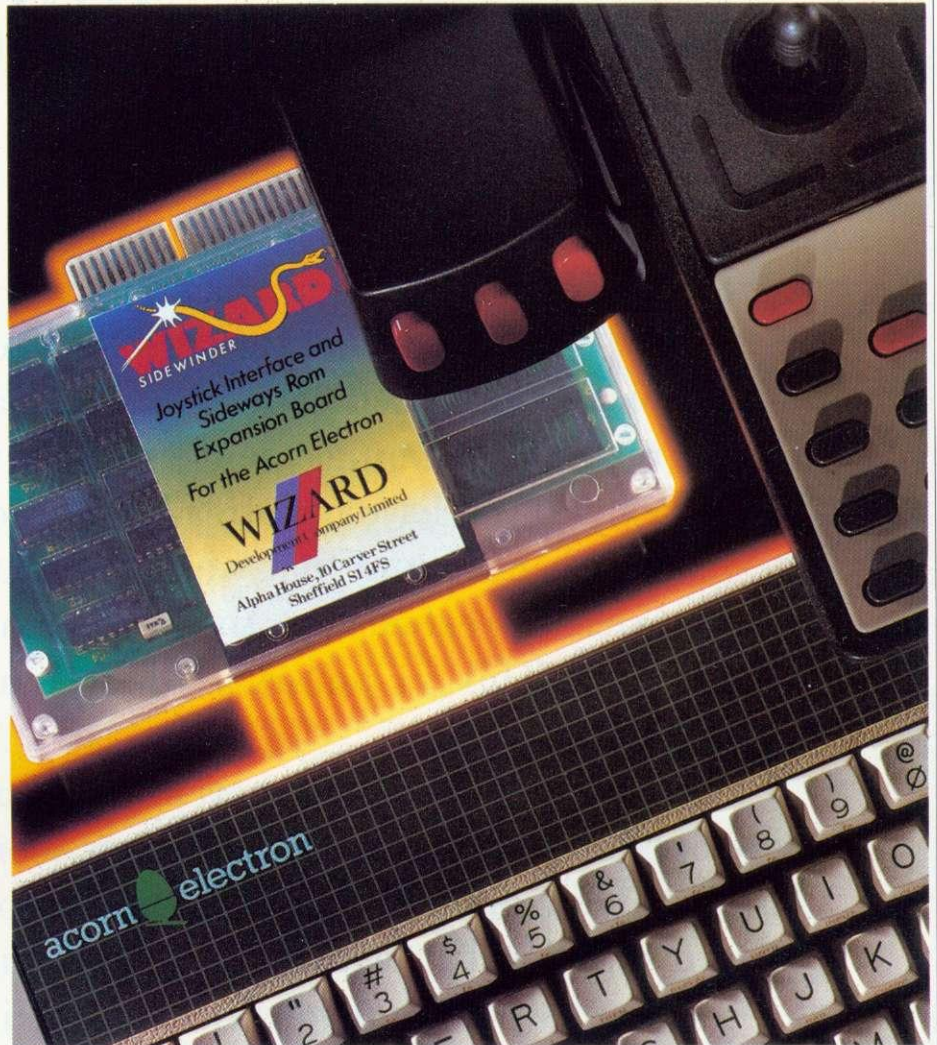

stuck with the old problem of not always knowing if the unit will work with your favourite games. If you want it to work with any particular software you should check first.

You can see the three spare ROM sockets (next to the *Joy* ROM) through the plastic cover. The cover is easy to remove and you can insert programmed ROMs of size 2764 into any of the spare sockets and also apparently into the *Joy* ROM's own slot. I used Beebugsoft's *Toolkit* ROM and it seemed to work without any trouble. Although not claimed in their advertisements, Wizard have told me that a small adjustment to the Sidewinder will allow it to be used for sideways RAM: anyone interested should contact Wizard for confirmation and details.

With the Plus 1 attached I was able to alternate between the *View* cartridge and the

Toolkit and *Joy* ROM: one of the advantages of a ROM board is that you can easily switch between ROMs. For example, it was very useful to have these last two ROMs 'on call' at the same time when I was writing a joystick routine for the Sidewinder.

Those interested mainly in using ROMs will judge Sidewinder according to the system they want and can afford. I would think that this unit's main strength will depend on its ability to convert current popular software to work with a switched joystick. Nevertheless, this is an interesting combination and may make a useful addition to the choices available for expansion. Now, where are those mountains . . . ?

Sidewinder, £39.95

Wizard Peripherals, 29 Glenalmond Road, Banner Cross, Sheffield S11 7GW. Tel: (0742) 683435.

If you purchased a Master 128 or ET between January-May 1986 please read on.

This is an important message for users of BBC Master Series micros purchased between January and May 1986. You should read this announcement carefully then contact your Acorn dealer if you have not already done so.

It has been found that when the battery in the above models is close to exhaustion, the microcomputer may attempt to recharge it. This is contrary to the recommendations of the battery manufacturer.

An upgrade kit which prevents this happening has been developed and is now available from any Acorn dealer at no cost. Fitting can be carried out easily either by you or free of charge by your supplier. This will not invalidate your guarantee.

If you have difficulty in obtaining a kit, please call 0223-214411 and ask for Department A2.

In the meantime, we suggest you follow standard electrical appliance guidelines and keep the power switched off when your microcomputer is not in use.

We apologise for any inconvenience that this upgrade will cause but we hope that Acorn's customers will be assured by our desire to maintain a high standard of product in the field.

Acorn 
The choice of experience.

REVIEWS

SOFTWARE

PRIVATE INVESTIGATOR

Powerful software to edit discs in depth, reviewed by Geoff Bains

Advanced Computer Products has produced some remarkable software recently and the latest is the *Advanced Disc Investigator* (ADI). This ROM-based package costs £28.75 and is worth every penny to the serious disc user.

The ADI is a language ROM providing a very flexible disc editor. It can deal happily with a standard BBC micro with an 8271 disc controller chip, and a B+, Master or Electron with Plus 3 with a 1770 chip.

The ROM is called with *ADI which displays the *Advanced Disc Investigator* command screen. Displaying a rare sense of humour, ACP has designed this screen to look like a disc inside its sleeve. On the 'label' of the disc is the command menu, on the 'sleeve' a window shows the status of the package and the bulk of the screen displays the output.

The ADI offers you 17 commands to manipulate your discs. The commands are selectable either by moving the cursor along the single letter mnemonics displayed and selecting the required letter with the Return key, or by typing in the initial letter of the command itself. The choice of methods provides a very easy way to enter commands that will satisfy any tastes.

Status display

The status window not only displays the current status of the program but also allows you to change it. Various parameters are displayed, including the drive number, the number of tracks, and density of the source and destination drives, the first track and number of tracks to be operated on by the command selected, and the first sector and number of sectors to be used by the command. Other current parameters include: track information such as length in bytes and track, head, sector, and length IDs, the current operation being carried out by the floppy disc controller chip, and the result of the last operation.

These parameters can be altered using the cursor keys in conjunction with the Shift key. The parameter to alter is selected with the horizontal cursor keys and Shift, and its value increased or decreased with the vertical cursor keys and Shift.

For some unknown reason ACP has elected to use the up key to decrease a value and the down key to increase it! Crazy, but at least

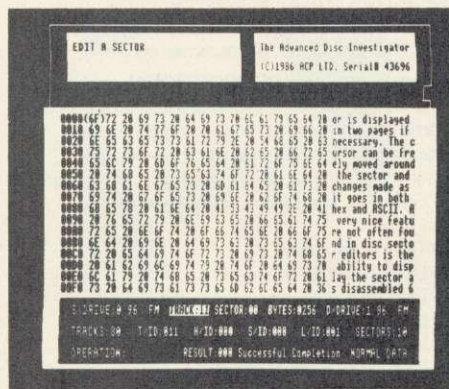

ADI displays several useful parameters

values can be entered directly from the keyboard as well.

The first and most useful command will Copy the contents of one disc onto another. This is not a normal backup command but a complete disc copier that will copy strangely formatted tracks across as they are recorded, and generally work its way past most protection. It is a simple matter to alter the relevant drive sections of the status window to, say, copy a protected 40 track disc onto another for use in 80 track drives.

The ADI's Verify command does not check a disc for valid data as DFS verify commands do. Instead, it checks the contents of one disc against another to see that all has gone well during the copy operation.

The third command is to Edit a disc sector, and is very similar in operation to most disc sector editors. The sector is displayed with both hex dump and ASCII field. However, as the *Advanced Disc Investigator* can deal with all discs created using the 8271 and 1770 controller chips, it must cope with sectors which are considerably longer than the Beeb's standard 256 bytes of data, so the sector is displayed in two pages if necessary. The cursor can be freely moved around the sector and changes made in both hex and ASCII as it goes. A very nice feature is the ability to display the sector as disassembled 6502 codes.

If the detailed workings of strangely formatted discs concerns you then the Scan command will be useful. This reports on the track, head, sector, and length ID codes from each sector of the disc and the sector's length in bytes.

The *Advanced Disc Investigator* is also capable of formatting a disc to any strange format

which it can read. The Format command will format any number of tracks to any specification the controller chip can handle according to the information in the status window.

The skew and field gap sizes can also be changed with the Modify command. These affect the most basic workings of the controller chip and being able to control the formatting in this way means that just about any format of disc can be created. If you have a 1770 controller chip you can easily use the ADI to, say, create discs readable by an IBM PC.

Even more amazing is the Unformat command. Although this will not literally restore sections of a disc to their new condition, it formats them in such a way that the disc controller cannot recognise them as formatted.

ROM routines

Several of the rest of the commands available in the *Advanced Disc Investigator* are really routines used by the ROM itself. These allow you to read in sectors from the source disc to a RAM buffer, edit them in a similar way to the disc sector editor, and write them out again to the destination disc.

The final *Advanced Disc Investigator* commands turn the printer on and off for a permanent record of the disc contents, restore the status parameters to their default values, and allow *commands and OSWORD 7F calls for the floppy disc controller chip to be issued.

The *Advanced Disc Investigator* is without a doubt a powerful piece of silicon. Its operations comprehensively cover just about anything you might want to do with a floppy disc – backing-up, repairing corrupted tracks, creating protected discs, not to mention just editing a wider range of discs than other editors can manage. The manual introduces each command in a clear and concise manner and gives a brief description of all the various ID codes and parameters that go to make up a disc sector. However, very little is actually said about how to use these either to overcome or to instigate protection on a disc. This is a shame as it can only put off newcomers to this field trying this otherwise excellent product.

Advanced Disc Investigator, £28.75 (ROM)

Advanced Computer Products, 6 AVA House, High Street, Chobham, Surrey GU2A 8LZ. Tel: (0276) 76545.

NEW BBC PRODUCTS FROM CLARES

Enhanced

BETA-BASE
£25



SPECIFICATION

- | | |
|------------------|--|
| 1) Random Access | - disc based, single or dual drives |
| 2) File Size | - max 65,000 records |
| 3) Record Size | - up to 2048 characters and 200 fields |
| 4) Field Size | - up to 254 characters |
| 5) Holds | - approx 1200 ADDRESS records per 100k |
| 6) Search | - 5 search fields using powerful options |
| 7) Sort | - 500 records on 3 fields in 60 seconds. |

SYSTEM FEATURES

- *CALCULATE - using any valid expression
- *PRINTOUT - Powerful options
- *REDEFINE - Titles, fields etc.
- *TRANSFER - From one file to another
- *GLOBAL ENTRY - of repetitive data
- *SEARCH LISTS - Allow creation of sub Databases within main Database
- *SPOOLER - enables you to create spooled files that are compatible with Wordwise, View etc.
- *INPUT - is a routine included on the disc which will allow you to write your own utilities for accessing your data. Many of the programs on the utilities disc were written using this procedure

BETA-BASE
UTILITIES £12.00



Extend the power of Beta-Base with the extra facilities provided on this disc.

- *MAIL MERGE
- *LABEL PRINTER
- *DISC SORT
- *EXTENDED SEARCH
- *FREE FORMAT TRANSFER
- *FAST PACK
- *STATUS

The MAIL MERGE alone is worth £12 so you get a real bargain with this disc. The features are so numerous that we cannot mention them all here.

Ask for our UTILITIES DATA SHEET if you want more information.

FONTWISE PLUS £20.00



Due to the phenomenal success of FONTWISE we just had to make FONTWISE PLUS compatible with VIEW as well as WORDWISE and WORDWISE+, at your insistence!

Now you can have PROPORTIONAL and JUSTIFIED text in 12 different fonts, all within the same document if required. In addition to the standard facilities like line and page length, pagination, left margin etc. we have now added

- Enlarged, standard & condensed fonts
- Tabs
- Temporary indent
- User definable line feed
- User definable character spacing
- Non proportional fonts
- Now with 12 fonts
- Plus many more features

If you are not convinced ask us to send you a sample printout and you will be amazed at the quality - requires an EPSON compatible printer capable of single, double and quad density graphics but you do not require any RAM in your printer to use FONTWISE PLUS.

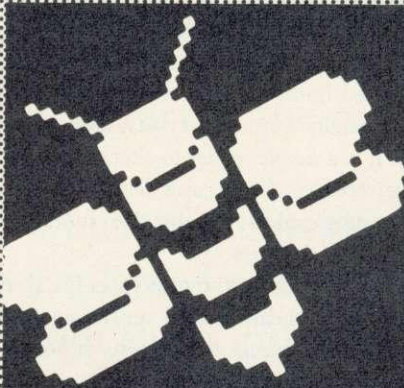

MACROM £40
£35 DISC



MACROM is a fast full featured MACRO ASSEMBLER ROM that allows the use of macros, which are loaded from a macro library stored on disc. Assembly can be from disc to memory, disc to disc, memory to memory or memory to disc, thus allowing the use of very long source code up to the length of your disc. MACROM source code is tokenized and thus takes up far less room in memory or on disc than most assemblers.

- Operate in any mode
- Tokenized source code
- Assembles 6502 & 65C02 codes
- Automatically loads macros from library on disc
- Automatically loads subroutines from disc
- Macro library supplied plus demo files
- Chain program sections into main code
- Many different assembly options
- Converts BBC assembler code into MACROM source code
- Very fast & very flexible

In a comparison with ADE, MACROM was able to assemble a program to disc in 1 min 24 secs compared to 5 minutes with ADE and the source code took up 30% less room on the disc.

Ask for a data sheet today

BROM PLUS
£34.50



£30
DISC



BROM was yet another of our runaway successes and such has been the demand for extra features that we have now produced BROM PLUS. Most of the original BROM favourites are there plus a whole host of additional commands to aid you, the user.

Commands include:

- EDIT - a FULL SCREEN EDITOR, not to be confused with the line editor used in other toolkit ROMs
- ERROR ON traps errors and enters the EDITOR
- FIND all occurrence of a string or keyword and enter the editor, TAB will find the next one and so on
- SCHANGE a search and replace facility
- LCOPY & LMOVE allow you to copy and move lines
- PACK is a very powerful routine which removes REMS & spaces and forms multi statement lines in a very intelligent way
- RENUM is a partial renumber facility
- XREF allows you to cross reference your program
- COMPARE a file against memory
- DEDIT a robust disc sector editor
- DFIND to search a disc for a string
- DGET/DPUT to load or save sectors
- FORM allows you to format up to 4 disc sides
- MENU to load programs from a disc with a BROM menu
- XCOPY to selectively copy files from disc to disc
- XDEL to selectively delete files from a disc
- MEDIT to view and edit memory - FAST
- ROMLIST lists all ROMs and their current status
- ROMON & ROMOFF which enable you to turn on/off sideways ROMs even after CTRL/BREAK.

"This is the best BASIC screen editor I have so far used."

MICRO USER August '85



DISC

40 _____ 40 TRACK

80 _____ 80 TRACK

3 _____ 3" DISC - ADD £3

EPROM

Send for detailed newsletter.
All prices inclusive of VAT & Carriage -
NO EXTRAS! Please state 40 or 80 track disc
and state D.F.S. you use

clares

MICRO SUPPLIES

98 Middlewich Rd.,
Northwich, Cheshire CW9 7DA.
Tel: 0606 48511
Open 9—5pm Monday—Friday
LUNCH 12.30—1.30

REVIEWS

H A R D W A R E

ACORN'S SUPERCOMPUTER

Peter Voke witnesses the 32016 Second Processor in action

The BBC microcomputer is almost unique in its design as a stand-alone personal or education computer that can also act as a 'front-end' for a different and possibly much more powerful second processor. The concept proved fruitful for Acorn when it brought out the Master series: by putting the 'back-end' processors inside the case, the hybrid BBC micros can serve a variety of markets, with Turbo, Master 512 and SC versions catering for the home enthusiast, small business user and higher education markets respectively.

The Master SC is not out yet, but its precursors, the 32016 Second Processor and the Acorn Cambridge Workstation, have been around for some time. Little is heard of the 32016 processor partly because of the very specialised market it is aimed at; it is designed primarily for use in colleges and universities, and Acorn have only sold a few hundred machines so far. As I hope to explain, the 32016 is a very different proposition from the more familiar 6502 and Z80 second processors.

For one thing, it costs more: 32016s are available with one megabyte (mb) of RAM, costing typically £1400. (The Master SC was originally said to have half a megabyte, though most of the software available needs 1mb.) The Cambridge Workstation is basically a complete 1mb system with separate keyboard and screen included, costing £3480 plus VAT; there is a 4mb version of the Workstation, too. It is immediately apparent that the 32016-based systems are not ordinary 'home' machines. To find out more, there is no better place to go than Queen Mary College in the East End of London, which has no less than 80 of the 300 machines Acorn have sold.

The 32016s at Queen Mary College (QMC) are being used in two quite distinct ways. Sixty-four of the 80 machines are linked up in Econet networks; each network consists of up to 12 processors (each plugged into its own BBC, of course) together with its Winchester hard disc fileservers. The other machines, however, are being used as personal supercomputers by individual members of staff who have number-crunching research projects under way.

The individual academics who have 32016s are all fairly pleased with them. Most are using the 32016 Fortran-77 compiler, which can

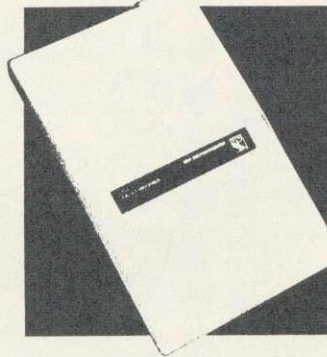

Little is heard of the 32016 processor partly because of the very specialised market it is aimed at; it is designed primarily for colleges and universities

handle Fortran programs ported straight on to the 32016 from the London University network. I spoke to Dr Andrew Tworkowski, who was running programs originally developed for the university's Cray-1, one of the fastest supercomputers in the world. Andrew was using the 32016 to pursue his research on chaotic dynamical systems, and getting the same answer using double precision Fortran on the 32016 as he had got from the 64-bit Cray machine. For his programs, running time on the 32016 was about 140 times longer than on the Cray, so programs that had taken half an hour on the supercomputer took three days on the 32016. But since the Cray had to be shared with many other users, a job like that would frequently take up to a week to be run on the supercomputer. Andrew now gets his results faster, using a machine that is more than a thousand times cheaper.

Individual supercomputers like Andrew Tworkowski's 32016 are an immensely attractive proposition, and anyone who wants a desk-top Fortran engine and doesn't need more than 1mb total memory should consider one. You may not always get one-140th of the speed of a Cray-1, but my tests suggest you will never get worse than a 700th, which is still

impressive. Andrew's 32016 co-processor and BBC micro have never broken down, and are run from double 80-track floppy drives. Other academics are using them for statistical analysis in biology, or doing long Fourier transforms on data taken directly from instruments.

Of course Fortran is not the only possibility: 32016 Assembler, Pascal, Lisp, Basic and BCPL are all available, plus several packages run within or using these languages, such as the *Gino-F* (for Fortran graphics), *GCAL* (a text processor written in BCPL) and the algebraic manipulation package *Reduce* (in Cambridge Lisp). The languages are all standard (Fortran has the WHILE statement as an optional extension), and generally appear top-notch. If you are keen on Lisp, make sure it is the dialect you want. If BCPL is what you are after, try it first; it is probably the weakest of the languages on the 32016. Prolog is promised, along with more applications packages.

The main complaints are that too many important features had been 'promised' by Acorn for far too long. Sounds familiar enough. Crucially, the 32016 still does not have a good straightforward wordprocessor - you have to use *GCAL*, or make do with *View* on the BBC micro. The popular scientific wordprocessor *Vuwriter* is promised, but the current version is unusably slow according to Acorn. Vuman, the authors of *Vuwriter*, are trying to speed it up.

A rather less rosy story comes from those who are using the networked 32016 processors. David Pick, who as head of Small Systems in the computer unit at QMC has his own 32016 in his office but is also in charge of the software for the networked machines, sums up his mixed experiences by saying: 'When they are good they are very, very good, but when they are bad . . .'

Quite simply, in the months since the 32016 networks were set up, single machines have crashed far too frequently. When use of a network has been high, it is possible for the whole network to crash so that it has to be rebooted from scratch. Of course this can happen on any Econet; but the large files that a network serving 32016s has to transfer seem to make the problem more frequent. Lecturers who are trying to teach Fortran, Pascal or Lisp to groups of first or second year students were

ALL PRICES INC VAT*

PRINTERS

EPSON FX80+	442.75
EPSON LX80	225.00
EPSON LQ1500	975.00
JUKI 6100	350.00

DISC DRIVES

CSX100	90.00
CS100	120.00
CSX400/S	114.95
CS400/S	139.95
CDX800/S	214.95
CD800/S	230.00
5.25 BLANK DISC'S	12.00

FIRMWARE

WORDWISE	36.00
WORDWISE+	48.00
DISC DOCTOR	30.00
PRINTMASTER	30.00
SPELLCHECK III	41.40
VIEW 2.1	50.00
VIEW 3.0	68.00

DISC SOFTWARE

BETABASE	25.00
REPLICA III	14.00
VIEW PRINTER DRIVER	10.00

B.B.C. CABLES

PRINTER	6.50
SERIAL	6.50
CASSETTE	3.00

HARDWARE ADD-ONS

VIGLEN CARTRIDGE	15.95
VIGLEN SPARE CARTRIDGE	2.95
ATPL ROM BOARD	44.85

MONITORS

STD RES. M'VITEC RGB	201.50
PHILIPS GREEN BM7502	79.00
PHILIPS COLOUR CM8501	209.95

MOUSE

MOUSE + SUPER ART	80.00
PAGEMAKER	49.00
DESK	21.00
PAINTPOT	14.00
DATABASE	24.00
3D ZICON	24.00

B.B.C. IC'S

ACN DFS KIT	65.00
DNFS	25.00
BASIC II	22.17
1.2 O/S	6.75
SERIAL ULA	13.35
VIDEO ULA	17.25
7002	9.31
8271	40.00
3691	4.00
88LS120	4.00
6502	6.00
6522	5.00
PSU	50.00
27128	3.60
2764	2.50

SOFTWARE & ORDERS ABOVE £5 add £1.80 P&P
 SOFTWARE ORDERS BELOW £5 add £0.50 P&P
 HARDWARE ORDERS add £5.00 PER ITEM
 • DISKETTES BOX OF 10 INC FREE LIBRARY CASE £10.95
 • HELPLINE: CALL DAVE BETWEEN 5PM & 6PM TUES-SAT 11 x 9 1/2. £13.00/2000
 • PRINTER RIBBONS. PLEASE PHONE

EXPRESS SPECTRUM, BBC and COMMODORE REPAIRS!

SPECTRUM REPAIRS BETWEEN £9 and £20

BBC REPAIRS BETWEEN £14 and £45

COMMODORE REPAIRS BETWEEN £14 and £35

WHY PAY HIGH 'FIXED' PRICES

(We do not charge you for our fancy premises by charging high 'fixed' prices!)

Reputations take time to build, we have been repairing ZX81's, Spectrums, QL's, Apples and BBC's professionally, for 2 1/2 years - who is coming second?

in all U.K. with While-u-Wait repairs! with INTERNATIONAL repair service!

FOR PROFESSIONALISM - "Of all the repair companies 'Sinclair User' spoke to, MANCOMP seemed the MOST PROFESSIONAL when it came to advice and a helpful attitude" AUG 85.

FOR HONESTY - We let you watch your computer being repaired and if there is nothing wrong with it, we will tell you!!!

FOR REPUTATION & HELPFULNESS - "I have come across a firm that will be more than willing to advise you as to how to remedy your problems. They are called MANCOMP and as well as repairing faulty computers, are also quite willing to discuss your problems with you and offer reasonably cheap and more importantly CORRECT CURES" Phil Rogers POPULAR COMPUTING WEEKLY JAN 85.

Every parcel sent by Royal Mail Receipted Post and insured for return journey! (For next day delivery include £1.50 extra).

(Securicor by prior arrangement). On-site maintenance for Apples, I.B.M.'s and most makes of printers also available.

Guaranteed 4hr response!
WHY DELAY - OUR ESTIMATES ARE FREE AND WITHOUT OBLIGATION. IF YOU DO NOT LIKE OUR ESTIMATE WE WILL RETURN THE COMPUTER AND REFUND THE POSTAGE INCURRED!

EXTRA-SPECIAL DISCOUNTS FOR EDUC INST., H.M. FORCES, CHARITIES, HOSPITALS, ETC!

Hardware and software design problems? Contact us for the complete service, from design through to manufacture.



MANCOMP LTD
(Dept. AU9)

Printworks Lane, Levenshulme, Manchester M19 3JP

Phone 061-224 1888.
OR 061-224 9888.

Terms and conditions available on request.

What we do today... others do tomorrow!

OPEN MON-SAT 9AM-8PM

Klick

The flexible computer benching system



The Klick flexible benching system has been designed for constructing free standing benching which can be assembled quickly and easily. The Standard range is available in 3 heights and can be supplied with a selection of underbench storage units. The Flexi range provides the scope for any unusual size, height or configuration required. For product brochure and price list please contact:

Store Stock Systems Ltd, Claverton Road, off Floats Road, Wythenshawe, Manchester M23 9NE Telephone 061-998 9726

DDX iMAGINA

BRITISH BROADCASTING CORPORATION
MASTER SERIES MICROCOMPUTER

iMAGINA, our new document illustrator, and DDX, our powerful and popular 2-D CAD system are both now available in specially-developed versions for the Master Series computers. These latest versions take full advantage of the improved memory management, graphics and extra speed of the Master Series to make them even more effective aids to illustration, graphics, design and drafting.

iMAGINA is a system for creating illustrated documents. It can be used with View or other word-processors which allow you to use the two new commands #image and #imagine to print text and graphics together and to integrate graphics into document files. Graphics can be created using the iMAGINA artwork editor or taken from other software. iMAGINA is a document-based system - not simply a page make-up program - all your normal word-processor editing facilities and printer typefaces are retained and no limit is placed on the number of pages or images in a document.

The iMAGINA artwork editor features user-friendly icons and pull-down menus controlled by mouse, trackball, Grafpad or cursor keys - no commands to remember and minimal keyboard use. There is a choice of line styles, brushes, and large text fonts, and you can choose from a selection of standard fill patterns, typefaces and symbols, or design your own using the utility programs provided. Drawing facilities include rectangles, polygons, circles, arcs, ellipses, painting, pattern-fill, clipboard, copy, move, erase, rubber-banding, snap-on grid, on-line help,.... Images up to 8 x 9 in may be printed on most dot-matrix printers. iMAGINA is available for the BBC model B+128 with the Acornsoft GXR ROM or for the Master Series and costs just £50.

DDX is a versatile drafting system, widely used in professional design offices and in higher education. The unusually sophisticated input routine accepts a very wide range of coordinate formats and the screen cursor may be controlled directly by the cursor keys and a mouse, trackball, Grafpad, joystick or digitiser. An impressive list of single-key mnemonic keycodes ranges from several line types through circles, arcs, ellipses, etc. to facilities found on up-market CAD systems - dimensioning, area measurement, macros,.... Outputs to most dot-matrix printers plus optional drivers for most plotters. DDX for the BBC model B (and B+) costs £125 and for the Master Series £150.

Our growing range of personal design software for the BBC micro also includes Digital Drawings, a simple 2-D CAD program - now only £50! 3-D View, a wireframe modeller/perspective generator, at £35 (plus optional plotter drivers from £15!) and ICE, a thermal insulation/condensation evaluator at £35. Please add £2 carriage plus 15% VAT and enclose a cheque with your order or ask for more details from:

IBBOTSONS DESIGN SOFTWARE

The Byre . Ecclesbourne Lane
 Idridgehay . Derbyshire
 DE4 4JB
 tel. 077 389 658



REVIEWS

HARDWARE



Deborah Pollard of QMC had some grim experiences with the early versions of the Panos operating system

keen on the 32016s at first; but their enthusiasm soon cooled as their students started to give up in disgust, put off by the regular unreliability of the networks.

In defence of the 32016 (and Acorn), it should be said that QMC is what the Americans would call a 'beta test site'; in other words a field trial site for many of the systems (hardware and software) that make up the 32016 package. In particular, QMC has been deliberately pushing the Econet networks as far as they will go – and probably a good bit further. It may well be that QMC has seen every problem that can crop up on the 32016, and that they are now nearly ironed out.

Deborah Pollard, who runs the Computer Aided Design and Education Centre at QMC, has had some of the worst experiences with her relatively small network in the Centre. Machines typically crashed three or four times a session with the older versions of the operating system, Panos. Deborah emphasises that things

have improved markedly since the field trial version 1.3 of Panos was installed recently, and is expecting that things will run a lot more smoothly next academic year. Loading files and linking compiled code for running are both much faster under Panos 1.3, though someone used to other well-known operating systems will still find such actions as loading or deleting files rather slow.

A number of good computer aided teaching programs had been brought across from the College's ICL mainframe (a straightforward process) and ran without too much alteration. Standard Fortran-77 will usually run first time on the 32016. Programmers used to a mainframe find the 32016 a bit short on facilities such as Fortran debugging diagnostics, the ability to link in libraries from one language to another, a Basic compiler or the means to dump a screen to disc or printer. The 32016 is still limited to some extent by the BBC micro, and is less than ideal for Computer Aided

Design; there is no mouse or trackerball software, and the screen resolution is too low. Deborah also commented on the lack of a decent wordprocessor or spreadsheet for the 32016 (*Matrix 3* is 'promised', like *Vuwriter*).

In spite of these complaints, what I saw in the Centre seemed impressive. Most of the work is done in Fortran, and the facilities for creating, compiling and running code seem attractive and easy to use. Regrettably there are still a few bugs in the screen editor (which is otherwise excellent) though most have been eliminated in Panos 1.3.

The Pascal and Lisp have been used by lecturers teaching in the Computer Science Department, but the networks have caused just as many problems in these contexts. A course on algebraic manipulation using the Lisp program *Reduce* could only take place at all because of the facilities provided by the 32016. Unfortunately, the large amount of code required students to interact frequently with the Win-

REVIEWS

HARDWARE

chester over the network – and the crashes have been correspondingly more severe.

The 32016 is now reaching the point where it may well get – and deserve – more attention. The richer secondary schools or sixth-form colleges might consider a few in a network, if the demand is there for Fortran, Pascal, Lisp and/or C. If you are thinking along these lines, then bear in mind that the software does cost extra, and don't expect to save cash by cutting corners. Even a small network needs a Winchester hard disc, and should be installed on the basis of a one or two month acceptance test. Insist on the latest version of Panos, and if the network doesn't stand up under the most gruelling use your students or sixth-formers can subject it to, throw it back at Acorn and ask for your money back.

This hard-nosed approach is probably the only way to deal with a system that can vary from wonderful to worse than useless: from giving each of your students the power of a small VAX supermini to the sort of unreliability that puts people off programming for life. If

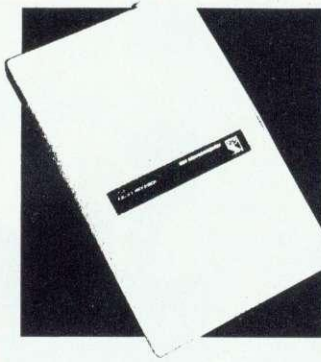

In defence of the 32016 (and Acorn) it should be said that QMC is a field trial site for many of the systems that make up the 32016 package

you are an individual researcher or freelance software developer, the 32016 is well worth considering. The totally standard Fortran and Pascal mean that programs developed on the 32016 will run on any mainframe. If you wish to get results, remember that a personal 32016 can give you hardcopy output about as fast as a supercomputer shared with a few hundred other users, for less than the cost of a motor-bike. If applications packages are what you are after, the 32016 is still rather weak compared, say, with the IBM. With the small installed base, it is hardly surprising that software is a bit thin on the ground. Acorn need to turn the vicious circle of software famine and unreliability leading to low sales into a virtuous circle of new software coming on line to supply a growing community of a few thousand enthusiastic and contented 32016 users. Maybe the Master SC will be the magic wand to perform that trick.

32016 second processor, £1295, Acorn Computers, Cambridge Technopark, 645 Newmarket Road, Cambridge CB5 8PD. Tel: (0223) 214411

We're standing printer

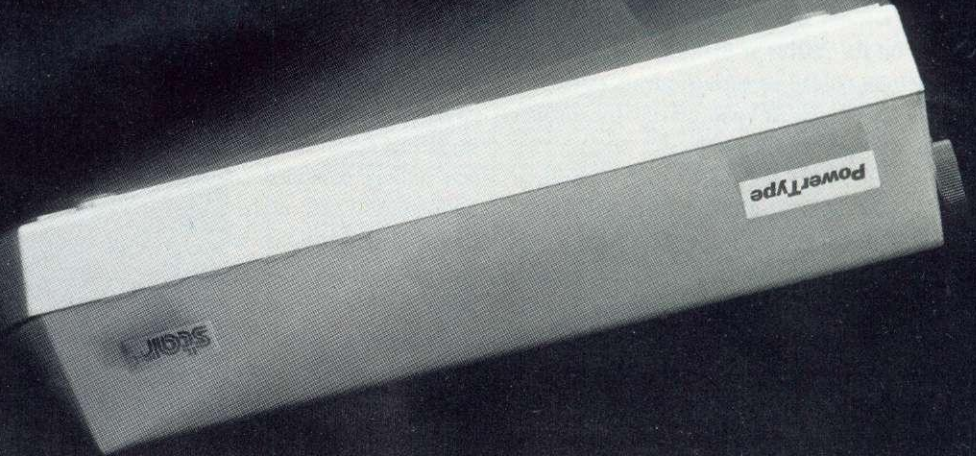

PowerType DAISYWHEEL PRINTER £229

With over 100 type fonts on widely available daisywheels and using standard ribbon cassettes, PowerType is remarkably cost efficient. A wide carriage giving up to 165 columns of beautiful print in the typeface of your choice, even a graphics capability, the flexibility of reverse paper feed and 18 characters per second means swift, classic correspondence. PowerType comes with Parallel and Serial interfaces as standard.

A&B Computing said in July that Powertype was a quality printer with a host of standard features, excellent value at £400 – How would they rate it now?!

STX-80 THERMAL PRINTER £79

This quiet and efficient machine prints at 60 characters per second and the compact thermal printhead, designed for dependable performance, will give you a lifetime service of 20 million characters.

REVIEWS

BOOKS

LOGICAL LANGUAGE



'Programming in Micro-PROLOG Made Simple', P H Hepburn, Ellis Horwood, £8.50

Micro-PROLOG is the language of artificial intelligence, adopted by the Japanese Fifth Generation project and taking over from Lisp in many applications. It's becoming popular in education because the basis of the language is logic rather than maths.

But for people brought up on Basic, languages like this can be hard to grasp. The manual which accompanies the Acornsoft micro-PROLOG software, for example, is practically unreadable for newcomers. That's what this book tries to put right. Most of it is based around five specific applications which serve as examples for the various principles and tech-

niques that are used in Prolog programming.

The book is not machine-specific. Micro-PROLOG version 3.1 (including the Acornsoft product) is almost identical across different machines, and so the programs in this book will run without problem on a Beeb. By the same token, however, the book doesn't properly cover the few machine dedicated primitives, such as file handling and graphics, so you will still need the standard manual.

Throughout the book the syntax used is for the SIMPLE supervisor which is loaded in over Micro-PROLOG. It has the advantage of being friendlier than the core language, but is a little less powerful. There are a few examples of core syntax, but they're not fully explained and someone wanting to tackle that subject would do better buying de Saram's *Programming in Micro-PROLOG*.

This book makes an excellent basis for classroom sessions, and also a good starting point for anyone wanting to make the move from Basic into this fascinating language.

Steve Mansfield

GOOD THEORY, BAD PRACTICE

'Interfacing Your BBC Microcomputer', Roger Morgan/Winston McClean/Joan Rosell, Prentice Hall, £8.95

Yet another BBC Micro hardware projects book, this time with a bias towards laboratory experiments. I suppose this book was aimed at students on technical courses, but this is just my guess, as reading it through left me still uncertain. The level of the material varies almost page by page, from the use of integral calculus to advice on how to wire up a relay. In general the levels of theory and practice are ill matched: the practical side often falls short of adequate support for good theoretical work.

There are good notes on the use of the Tube (quite unusual, this), and the programming examples are clear and well written.

A good book to pick and choose from, but not recommended for the hardware beginner.

Mike Barwise

prices on their heads.

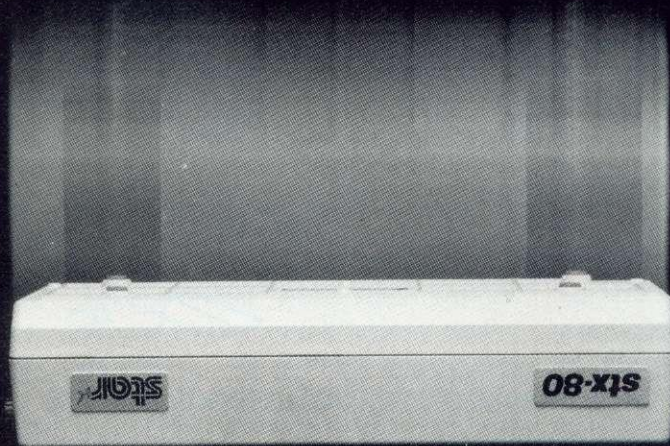

The STX-80 has a carriage width of 80 columns, graphics and many of the features of much larger printers. It's so quiet, the only thing that will make you shout is the price!

PowerType and STX are part of a range of exceptional quality printers - With prices this good you'll go head over heels for a STAR!

Ring - 0272 217777
for more information
(24 hour manned switchboard).

star

For more information and the address of your local dealer complete the coupon and send it to Star Micronics U.K. Ltd. Craven House, 40 Uxbridge Road, London W5 2BS.

Name _____

Address _____

GIVE YOUR BBC THE PC LOOK

WITH THE **Viglen** PROFESSIONAL CONSOLE UNIT (P.C.U.)

ONLY £49
(INCLUDING VAT)
PRICE INCLUDES
COILED CABLE



Give your BBC Micro System the professional PC-look by replacing your existing lid with this smartly styled package. House your computer, monitor, disk drives & ROM cartridge system neatly in this strongly constructed, high impact ABS unit, colour matched to the BBC micro, and give yourself an outfit to impress all who see it.

This unit will support monitors including 14" television sets.

Capable of accepting most internal expansion boards such as Solidisk, ATPL Sidewise, Midwich 16, RAMAMP 16+32k Exprom, Computer Village CVX16, HCR Sideways, 6502 2nd processor boards. Fully ventilated. Full fitting instructions.

DEALER
ENQUIRIES
WELCOME.



Package includes:

- Keyboard case
- Screened main unit casing including internal fittings
- 2.0 metre coiled cable to connect main unit to keyboard
- Blanking plates included to blank out disk drive aperture
- Keyboard label

ACCESSORIES (prices inc. VAT)

1. 2.0 metre coiled cable on its own £15
2. Dual-drive data cable £9
3. Dual-drive power cables £5
4. Special internal switch mode power supply kit capable of running two half-height drives cool running £29
5. Fan kit, only necessary in extreme cases £35
6. Fitting available from £15
7. Extension keyboard on its own £29
8. Also available with single or dual drives ready fitted *Price on Application*

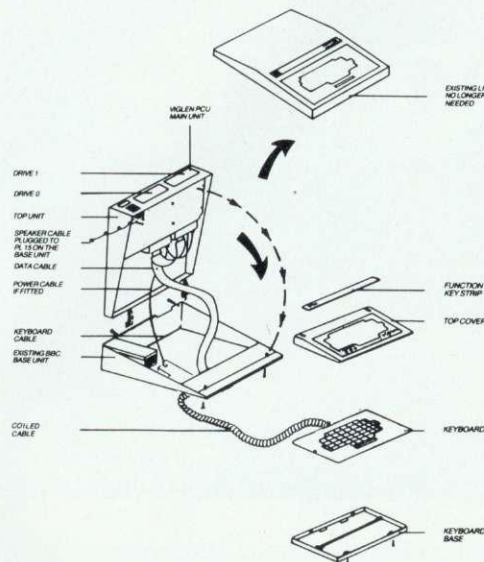

How to order:

By post - Simply fill in the coupon. Enclose your Cheque, P.O. or use your Access, Barclaycard. Please make cheques payable to VIGLEN COMPUTER SUPPLIES and post to the address stated.

Allow seven days for delivery. Add £6.00 carriage, packing and insurance.

Or telephone: 01-843 9903
Credit card holders (Access, Barclaycard only) can purchase by telephone. Please give Card No. name, address and items required. Viglen are also major supplies to educational and government establishments and welcome further enquiries and orders.

Unit 7, Trumplers Way,
Hanwell W7 2QA
Tel: 01-843 9903
Personal callers:
Monday-Friday 9.30-5.30pm
Saturday 9.30-2.00pm



Free
parking
available

Post to: **VIGLEN LTD., UNIT 7, TRUMPERS WAY, HANWELL, LONDON W7 2QA.**

Telephone: 01-843 9903 AU 9/1

Please send me _____ (Qty) VIGLEN PC Unit(s) Plus Accessories _____ State ref numbers

I enclose Cheque/P.O. for _____ Please add £6 for postage, packing and insurance.

I prefer to pay by ACCESS/BARCLAYCARD* Delete whichever is not applicable

Card No. _____ Signature _____

Name _____

Address _____

Postcode _____

Tel. No. _____

Credit Cards valid if signed by Cardholder.
Address below must be the same as card holders.



REVIEWS

HARDWARE

TRUE TO TYPE?

Bill Penfold gets his hands on a novel keyboard

In theory typewriter keyboards should be laid out entirely differently. In theory, the whole board should be a different shape – and that's the idea behind the Maltron ergonomic keyboard. Unfortunately it's probably not a viable theory. But before we start knocking the idea it is only fair first to consider what the conventional keyboard is like – and why.

Look at your own Beeb. Apart from the row of red function keys at the top, what you have is an ordinary, everyday English-language qwerty keyboard. (It is called Qwerty because those are the letters at the start of the first row beneath the numbers.)

When this layout was devised typewriters were of the old sit-up-and-beg variety. You bashed a key attached by a wire to a letter arm which then hammered an impression through an ink ribbon.

It wasn't difficult to get letter arms jammed together by rapid striking of two keys consecutively and, to prevent that, the designers decided the best thing to do was to slow down the typist a bit through the layout of the keys. And that is how we got the qwerty layout.

Bill's beef

I've had a long-running bellyache about the standard Beeb keyboard. This is because for touch-typists the BBC micro, despite its many virtues, is a bit too flat and cumbersome, a complaint which may come as a surprise to the majority of home computer users considering the standard of most other micros' keyboards. But for those used to hammering away at an old-fashioned, coal-fired typewriter, the BBC micro keys are a bit close and cramped: it is almost impossible to build up any real speed.

The first thing I did after being handed the Maltron package by a gloating editor was to try to buy a copy of Adam Faith's *What do you want?* The reason will be explained shortly.

Anyway, Maltron's kit for the BBC micro is quite an impressive package . . . at least in theory. First you have to replace your Beeb keyboard with a specially converted one to which the Maltron board can then be attached.

At first sight the Acorn board supplied with the package looks no different from the one already on your micro apart from the peculiar flexible connector trailing from beneath it. Turn it over, though, and you will see the



The unconventional layout of the Maltron

conversion work which is probably most kindly described as 'robust'. The only problem with mine was that the down cursor key did not work, which meant having to use the Return key to travel down the screen.

The Maltron board itself is fitted on to a black keyboard case similar in size to the Viglen remote console. Like your own Beeb it has a top row of 10 red function keys. But that is where any similarity ends.

The Break key is to the left of the function keys. The keys themselves are in four groups: two large groups of 27 on the right and 26 on the left. These cover all the characters apart from the 'E' and the full stop which are part of a small group of six keys on the left. The other four keys on the small left-hand group are Delete and CTRL plus two of the cursors. The right-hand small group also has Delete and CTRL keys plus the other two cursors. It also has a small single key for spacing instead of a space bar and a small key for Return. The idea is that the typist's hands can flick from key to key more quickly and with less stretching than on a conventional board.

With the package comes an introductory booklet promising 'greater results with less strain' and 'a new level of keyboard comfort and accuracy'. Also according to the booklet the 'new ergonomic shape minimises likelihood of physical harm to operators which can be caused by the old design.' Physical harm! I know people are worried about VDUs but will keyboards soon have to carry government health warnings as well? So it would seem. The alleged risks of typing on your common-organ garden keyboard are revealed at the back of the introduction with the reproduction of an article from a New Zealand magazine describing the health hazards of Repetition Strain Injury

(RSI) suffered by a typist using a word-processor. Pretty grisly reading – and I've put in for my danger money over this review.

The package also comes with a set of four cassette tapes. But don't try to load them on to your computer – they are instructions, not software. Finally there was a training manual of exercises – exercises which took me back about a quarter of a century and on to the search for Adam Faith's Sixties' hit.

Learning again

Trainee typists, while learning where each key is, bash away for hours at groups of letters designed to implant the keys' location to memory to the point that the typists' fingers go there automatically without thinking or looking. So too with the Maltron keyboard. It was a nostalgic reminder of days learning to touch-type, a would-be journalist among a classroom of would-be secretaries. Anyway, our instructor was a greater believer in the Rhythm Method for teaching you to type. We learned to tap away in time to Mr Faith. What do you want if you don't want money . . . Tap . . . tap . . . tap . . . tap . . . What do you want if you don't want gold . . . tap . . . tap . . . tap . . .

Inexplicably there wasn't a copy to be had anywhere in the High Street, just a blank look from the girl behind the record counter – 'Adam who?' To which I could only reply: 'Oh ye of little Faith!'

Still, despite this lack of essential training material, I finally completed my field trial, and my conclusion is that it's a nice idea – but one whose time has not come. And I doubt if it will. Risking the possibility that in another quarter of a century young trainee typists on their Maltron board will be shown these words to mock, I simply don't believe it will replace the qwerty board. It may be better. It may well be faster. But qwerty is too well established to be dislodged. Typists will continue to be trained on qwerty boards because that is what offices use – and offices will continue to buy qwerty boards because that's what millions of typists are trained to use.

Well, that's my theory . . . only time will show what happens in practice.

Maltron Keyboard £175.

PCD Maltron, 15 Orchard Lane, East Molesey, Surrey KT8 0BN. Tel: 01-398 3265

COULD YOU USE 16 COLOURS IN MODE 2?

- ★ Choose from a palette of 4096 selectable colours
- ★ Colours range from sharp contrasts to subtle shades
- ★ Hundreds of new colours available
- ★ The palette is simple to program using VDU 19 from either BBC Basic or Machine Code
- ★ Ideal for dramatic special effects in games, video presentations and many other applications
- ★ Easy fit board plugs inside the BBC Micro without soldering
- ★ Use in all modes

The Wild Vision Palettemate colour graphics card is a unique idea which greatly enhances capabilities of the BBC Micro. The actual displayed colours in any mode can be replaced with a selection from the palette of 4096, giving a staggering 16 separate colours in Mode 2. Moreover, the selection can be rapidly reprogrammed to give very dramatic effects. The system is very easy to install and connects to the linear inputs of an RGB Monitor via the standard connector at the rear of the BBC. A package of demonstration software and instructions is included.

Palettemate Graphics Card . . . **£149**
incl Carriage + VAT

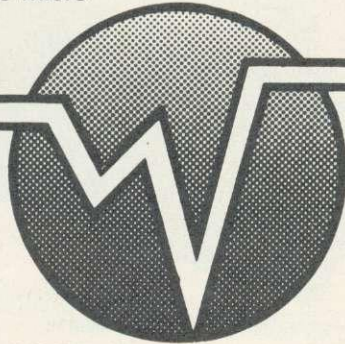

Wild Vision also produce the Hawk V8 Image Processing System for the BBC Micro. Its highly innovative design enables the BBC Micro to grab and process single video frames in real time, though it costs far less than similar systems.

Hawk V8 Image Processing System from **£925.00**

Applications include:

- ★ Medical imaging
- ★ Video measuring
- ★ Industrial automation
- ★ Scientific image analysis, microscopics
- ★ Robotic control
- ★ Graphics and CAD
- ★ Optical character recognition
- ★ And many more

Wild Vision

6 JESMOND ROAD · NEWCASTLE UPON TYNE · NE2 4PQ · TEL: 091 281 8481 · TELEX: 537038

☆☆☆☆ SUMMER SEASON SALE OFFER ☆☆☆☆

1/3 OFF ALL ROM's!

ADE is the complete program development package for assembly language programmers.

Proven and revised over a period of 2½ years ADE has set the standard by which all others are judged. If you are writing 10 lines or 10,000 lines of source code ADE is for you. The powerful EDITOR, macro ASSEMBLER and DEBUGGER are amazing value at this price. ADE comes complete with a 160 page comprehensive reference manual and a utility/macro library disc. Please specify 40 or 80T.

ADE
£40

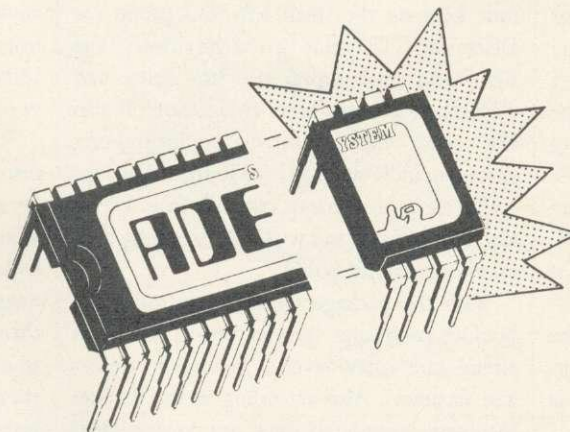

ASM
£23

ASM provides all the features of the ADE macro assembler. Use with other editors such as View and Wordwise. For enhanced debugging facilities use with the SPY2 ROM. Complete with reference manual and utility disc. Please specify 40 or 80T.

SPY2
£20

SPY2 is the most comprehensive of all debugging/disc utility ROMs. Apart from the full front panel debugging monitor SPY2 features single-step, multiple breakpoints, relocater, trace and 'versatile' disassembly facilities. The powerful set of disc recovery commands can be used for interrogating, editing and retrieving data stored on disc. Only available to 8271 dfs users. SPY2 also includes a disc formatter and a non-destructive single track reformatter.



0742
682321

All prices inc. VAT and P & P **SYSTEM** Dept. A. 12 Collegiate Crescent, Sheffield S10 2BA

HARDWARE / SOFTWARE

MASTER MEETS IBM – OR DOES IT?

Acorn's 512 co-processor claims to be reasonably IBM-compatible. But Bruce Smith finds that not all IBM software is happy on the Master

The Master 512 computer is the fourth of five Master series computers announced by Acorn in February this year. The 512 is in fact a co-processor board which plugs internally into any Master series machine. It comes bundled with GEM and the DOS Plus operating system, and professes to be reasonably IBM-compatible. Theoretically it should allow access to a phenomenal range of IBM-format software and, perhaps more importantly, allow users of this software to port it from one machine to another with no fuss.

The 512 board is very simple to install and Acorn must take credit for the overall design. Its small size belies the 512k of onboard RAM – don't get too excited though, as this is needed by the software. The co-processor is an 80186 chip which dominates the centre of the board. Once installed the system is brought to life by using a *CONFIGURE TUBE command. This hands control to the 80186 and the 4k Tube ROM then boots DOS Plus from a disc in drive 0.

DOS Plus

The Disc Operating System (DOS) Plus has been specially adapted for the Master by its authors, Digital Research. According to the manual it will 'support both IBM PC-DOS applications and CP/M applications', and is called compatible with CP/M-86, IBM PC-DOS 2.1 and MS-DOS 2.1. This effectively means that any program which conforms to these standards, ie, uses only the official system calls of either CP/M86 or DOS 2.1, will work on the Master 512.

For the uninitiated, a Disc Operating System is the basic level of operation of any computer of this kind. It supports a variety of commands which allow access to discs and include copying and deleting of files. The structure of the DOS is a hierarchical one and thus directories and sub-directories are supported. All files saved are timestamped using the Master's real time clock.

The most fundamental feature of any DOS is that it allows you to load application packages such as wordprocessors and databases which become your working environment. Meanwhile, the DOS stays at the

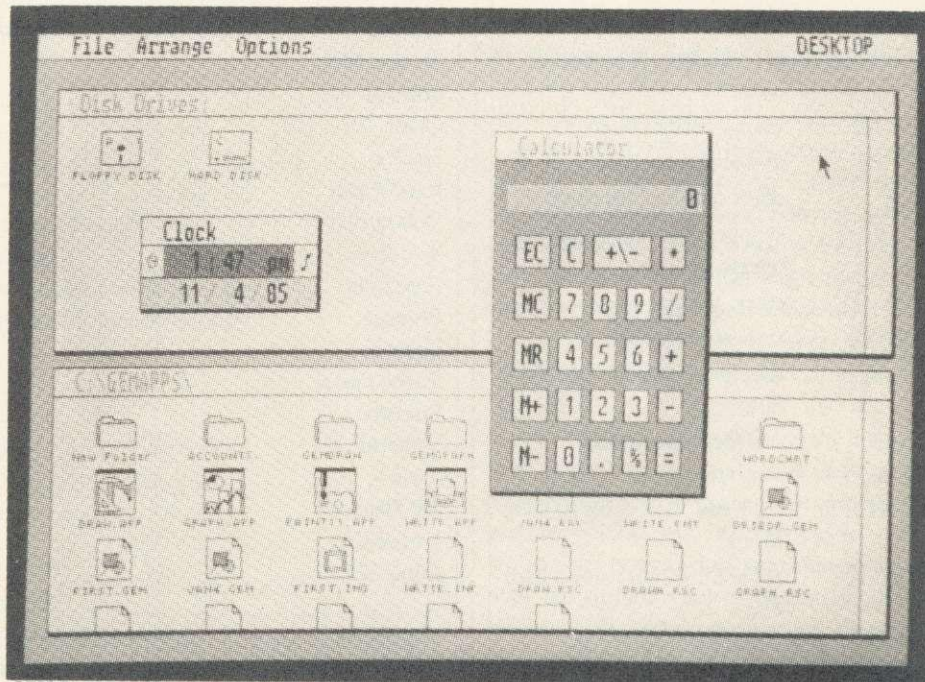

GEM Desktop: disc-based filing and administration system

IBM KEYBOARD	EQUIVALENT IN MASTER NUMERIC KEYBOARD
Alt	Copy
Home	7
End	1
PgUp	9
PgDn	3
Ins	0
Del	Delete
Runbout	Delete (next to Copy)
Num Lock	/
PrtSc	*
Scroll Lock	#
Break	#
Up Arrow	8
Down Arrow	2
Left Arrow	4
Right Arrow	6

Table 1. IBM-Master 512 keyboard emulation

lowest machine level, carrying out your filekeeping needs. Table 2 lists the DOS Plus commands. Lovers of CP/M will notice many similarities, particularly with commands such as ED and PIP. DOS Plus supports a Z80 emulation mode which puts you in a standard

CP/M 2.2 environment with all the nominal commands available. Complete compatibility, though, cannot be guaranteed – many of the Acorn Z80 programs make use of the Z80 ROM, so these will not work. Similarly, specialist system programs such as STAT get confused. However the manual assures us that most CP/M 2.2 programs will run, though I did not have time to put this to the test. One final point here is that the Z80 emulator is one of several aspects of the bundled software that, to quote the manual, '... is unsupported by Acorn', a subject I will say more about later.

Being able to run and understand IBM software means that the Master keyboard must also be capable of generating IBM keyboard codes. The 512 keyboard driver is designed to return the same values as the IBM PC. Many of the keys on the numeric keypad are used for this purpose – for example, the 7 key is the equivalent of the IBM Home key (see table 1). However, with the software I ran, pressing the required key combinations didn't always work, so obviously there are still problems.

Loading applications in DOS Plus is not always as fast as it should be – this is because it may have to recognise the format of a disc. The

REVIEWS

A:	select drive A
B:	select drive B
ALARM	real time clock/alarm
BYE	park hard disc read/write head
CLS	clear screen
CHDISK	check integrity of DOS Plus disc
COLOUR	change screen colours
COPY	copies a file, renaming it if required
COPY CON:	copy file from keyboard to disc
CHDIR	change current directory
DATE	display/change date
DIR	select specified directory
DISK	supplies menu-driven disc operations
ED	enters the text editor
ERASE	erases specified file
ERAQ	selective erasure of files from disc
FSET	sets file/drive related attributes
GETFILE	copy BBC ADFS file to DOS format
HDISK	as for DISK but using a hard disc
MEMDISK	create fast memory disc
MKDIR	create or make a new directory
NETPRINT	print files on BBC Econet print server
NOTUBE	leave DOS Plus and return to Master environment
PATH	set path route
PCSCREEN	select IBM screen emulation mode
PIP	advanced file copying facility
PRINT	print files as background task
PROMPT	change prompt
PUTFILE	copy DOS Plus format file to BBC ADFS format
RENAME	rename specified file
RMDIR	remove subdirectory
SDIR	display file status information
SET	display/change DOS Plus environment (ie, screen length, number of lines, etc)
STAR	pass command to MOS
TIME	display/change time
TREE	display all subdirectories on specified disc
TYPE	types file to screen

Table 2. DOS Plus commands

main format used is the Acorn 800k format – a few seconds may be added to the loading time if, say, a 360k IBM OC format disc is used. This can be got round by copying the software to an Acorn format disc.

Other problems may also occur, for instance, when using IBM PC 360k discs where the format is 40 tracks. When data is subsequently written to the disc on 80 track drives the result may not always be capable of being

applications: *GEM Desktop*, *GEM Write*, *GEM Paint*.

Briefly, *GEM Desktop* is a filing and administration system; *GEM Write* is a wordprocessor; and *GEM Paint* is a graphics program. GEM is a popular WIMP system – Windows, Icons, Mouse and Pulldown menus. You enter the application simply by typing GEM from DOS Plus, ensuring that the correct discs are installed in the drives. You

Software	Compatibility	Comments
TurboCAD	Y	
dBase II	Y	
Quest	Y	
Speller	Y	
Exec Writer	Y	
Volkswriter 3	Y	
Wordstar	Y	
Exec Filer	Y	
Promise	Y	
Draw it	Y	
Turbo Pascal	Y	
Logistix	Y	
Supercalc 3	Y	
Twin	Y	
VP Planner	Y	
Lattice C	Y	
Lotus 123	N	Copy protection mechanism tries to access IBM PC disc controller
Symphony	N	Copy protection mechanism tries to access IBM PC disc controller
dBase III	N	Copy protection mechanism tries to access IBM PC disc controller
RBase	N	Use of undocumented system calls
SDS-XP		
(MODula 2)	N	Package requires > 20 files open
VuWriter	N	Needs hardware dependent dongle

Table 3. Software tested by Acorn on the 512

read back into the IBM with the 40 track drives. This is because the read/write head mechanism on a 40 track drive is twice the width of the head in an 80 track drive and may have difficulties in reading the data.

Although the Master 512 is supplied with 512k of memory, DOS Plus takes a large bite into this – 154k to be exact. PC DOS 2.1 uses just 64k when running on an IBM PC, hence the usable space on a Master 512 is 90k less than the usable space on a 512k IBM PC. IBM PC packages that require either 256k or 348k memory space will run on the Master 512, but packages requiring more memory will probably encounter problems. Certainly those packages 640k in length will not run.

GEM

The Graphics Environment Manager (GEM) is supplied on two discs and contains three

first go into *GEM Desktop* from which you can perform housekeeping tasks or select the other two applications, which is done with the aid of a mouse. The mouse to be supplied with the release version will be a Far East import and have just two buttons. I have seen one of these mice at Acorn and can vouch for its good feel.

Much has been written about GEM in the popular computing press, so I don't intend to waffle on about it here other than to make a few observations for those of you who may not have come across it before.

GEM Write is an adequate wordprocessor, but it's not exactly easy or quick to use (my requirements for a wordprocessor). Mundane tasks such as inserting a line require the positioning of the cursor and the use of the mouse to pull down the correct menu to then select the item marked 'insert line'!

GEM Paint is a graphics package which on a

normal IBM machine will allow you to work in 16 colours. The limitation to two colours on the Master 512 is obviously a serious drawback, though reasonable results can still be obtained using the colours which appear as shades of grey.

Use of the Acorn colour driver (see below) can provide *GEM Paint* with four colours, but this produces worse results and the monotone mode is preferable.

Concurrent DOS

Although not supplied with the 512, Acorn will be offering the impressive Concurrent DOS for the Master 512. This is a version of DOS which allows up to four tasks to be running at the same time. For example, you could be using a wordprocessor such as *Wordstar* while another application was reading and writing to disc, at the same time as printing out a large document! The cost of

simply will not run because the protection mechanism tries to access the IBM PC disc controller chip. It is debatable whether publishers of such software will be willing to port the software for the 512: unless the 512 is a best seller the companies would undoubtedly wish to be commissioned by Acorn (at no small cost) to perform the task. Acorn is unlikely in the present climate to initiate such a commission, relying instead on third parties to act on their own initiative. It therefore looks as though the big three products (*Lotus 123*, *Symphony* and *dBase III*) will not see the light of day as far as the Master 512 is concerned.

Table 3 shows the software tested by Acorn and this is quite encouraging. Table 4 shows the IBM software I tested with the help of Simon Williams. This is software Simon regularly uses on his IBM clone – the results are less than encouraging as it proves that software is not directly transferrable. However, in many instances it might simply be a matter of reconfiguring the format of the software though we haven't yet put this to the test.

A typical example of the sort of problems which cropped up was when trying to use the excellent *NewWord* wordprocessor. This works fine, except when you want to use it with the spelling checker dictionary (this is resident and checks your spelling after each line, offering suggestions as you go). Here the message 'Files must be greater than 20' is generated. DOS Plus cannot have more 20 files open and so this software will not run on a 512.

Conclusion

Table 5 details the requirements for IBM compatibility. If you are thinking of investing in a 512, I cannot stress too highly the importance of choosing your software first. Ask Acorn or your local dealer if the software will run – get your dealer to prove it and only then should you part with your cash.

It is difficult to advise you on whether the 512 is a good investment. Certainly at the original price of £499 I couldn't see that it was worth the money, but Acorn has now finalised the price and it is a far more acceptable £399. However, if you want to run all types of IBM software and to buy more as you progress, then ideally you should look for an IBM clone, which can be had for between £500-£800. This price compares very favourably with the £900 needed for a complete Master 512, and the IBM clone price will include monitor and drives.

If you only want to run GEM or concurrent DOS or any of the tested software, you already have a Master and don't want the clutter of a second machine then, and only then, should the 512 co-processor be considered.

Title	Compatibility	Comments
Wordstar	Yes	
dBase II	Yes	
PCwrite	Yes	
PCtime	Yes	interrupt driven clock
NewWord3	No	files = 20 error
Homebase	No	will not recognise Alt/Shift
Sidekick	No	will not boot
PCfile	No	specialist public domain software
PCtalk	No	specialist public domain software
PCpaintbrush	No	
PC DOS	No	
Autodex	No	
Disclook	No	loads OK – hardware dependent
Discdump	No	loads OK – hardware dependent
IBM PC Games	No	hardware dependent

Table 4. IBM software tested by Smith and Williams

DOS Plus is designed to be compatible with IBM DOS 2.1 (this also includes MS DOS 2.1) Compatibility is achieved at three levels which are: the user commands; the operating system calls; and the ROM BIOS(ROS) function calls.

A number of DOS 2.1 compatible utilities are provided which give the user a similar command interface to that found on DOS 2.1. DOS Plus is system call compatible with DOS 2.1 and all documented DOS 2.1 system calls are supported.

DOS Plus also provides emulation of the IBM ROM BIOS functions. These so-called ROS functions are essential to support application programs that have been written specifically for the IBM PC or PC/XT. The ROS entry points are used by some applications for low level control of various pieces of IBM hardware, examples being: the reading and writing of screen memory; changing screen modes (note that this refers to the modes as found on an IBM video controller card, not modes 0 to 7 of a Master 128); reading and writing sectors on a disc; and scanning the keyboard.

Table 5. The requirements for IBM compatibility

Miscellaneous

The fourth and final disc in the bundle contains a variety of utilities, which includes the colour display driver. For normal operations the 512 operates in a high resolution, two colour mode (black and white by default). A colour driver can be installed which will enable GEM to run in a four colour, lower resolution mode. Like the Z80 emulator, the colour driver is not supported by Acorn and so must be considered a waste of time. I must admit my extreme disappointment at reading such comments in the manual. If a company is supplying software, it *must* support it otherwise it's useless to the user – even if it is thrown in for free.

Concurrent DOS is likely to be high when compared with standard BBC micro software: Digital Research's list price is close to £250 and Acorn is hoping to offer it for under £200. It should be available later this year.

Software compatibility

The 512 will sink or swim on just how much IBM software it will run. Acorn is currently testing packages and trying to adapt them where possible. Incompatibility in many instances is likely to be caused by protection and direct use of IBM hardware. For example, version 1 of *Lotus 123* will work with a small Acorn screen driver patch, but later versions

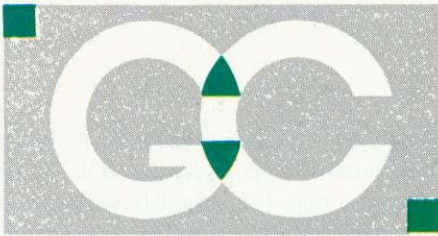

GRIFFEN COMPUTERS

CASTLE WALK, LOWER STREET
STANSTED, ESSEX CM24 8LP

TELEPHONE: 0279 812295

INTERSHEET - The first of the ROM-LINK integrated rom packages from Computer Concepts. Menu driven, 40/80/105 column display, very fast, can be used with View or Wordwise, up to 16 spreadsheet in memory at one time. Supplied on two roms with reference manual, function key strip and quick reference card. **45.95 (a)**

INTERCHART - The second ROM-LINK package and designed for Intersheet giving Bar, Pie and Line graphs. **29.95 (a)**

INTERWORD - The new wordprocessor from Computer Concepts of the WYSIWYG type. Allows 40, 80 and 106 column mode. **50.95 (a)**

INTERBASE - The new rom-link database from Computer Concepts. (available soon). **P.O.A.**

ACCELERATOR - The most comprehensive compiler yet for the BBC micro. Compiles nearly all Basic, including floating point arithmetic. Compiles to intermediate G-code or to machine code. Comes on two roms with manual, disc and quick reference card. **57.95 (a)**

WORDWISE - The standard BBC word processor still very popular allowing all normal features for low cost. **30.95 (a)**

WORDWISE-PLUS - The new 16k version of Wordwise giving added commands for better use. Using its own language mail merging, indexing, continuous processing and multi column text can be utilised. **44.95 (b)**

TTS SPEECH ROM - This rom provides the most powerful and comprehensive speech system available for the BBC Micro. You can make your computer speak by simply typing in what you want to say. Requires Acorn Speech Processor. (Available soon) **36.95 (a)**

SPEECH ROM - Using the Phoneme system this allows infinite speech. Both pitch and emphasis can be changed and if wanted it can also sing. Requires the Acorn speech processor. **27.95 (a)**

Acorn Speech Processor - bought with above - 10.00 otherwise 17.25 (a)

PRINTMASTER - This rom allows Epson or Star printers to be fully utilised easily. Includes a versatile screen dump, enlarged text, various text manipulation commands. **27.50 (a)**

DISC DOCTOR - Still a very popular disc utility rom giving many extra commands to any DFS. **27.50 (a)**

ADVANCED DISC TOOLKIT - Probably the most versatile & compatible toolkit rom available. It works with the Electron, BBC B, BBC B+, Master, 6502, Z80, DFS, DNFS, 1770 DFS, ADFS. It adds more than 30 extra commands to the BBC. **33.00 (a)**

BEEB TEXT PLUS - A unique BBC Micro text-display enhancer. Ideal for eye-catching carousel displays and videotitling. **19.95 (a)**

ADVANCED DISC INVESTIGATOR - a very powerful disc utility for standard and non-standard discs. Will back up protected discs and edits any type of non-standard disc. **27.50 (a)**

FLOPPYWISE PLUS - A very useful utility rom with a variety of new commands including Clone, Protect, Rom load and many more. **28.95 (a)**

BROM PLUS - Enhanced version of the original Brom allowing a whole host of additional commands. Still with the best full-screen editor available. **31.95 (a)**

BETABASE - A very useful database program allowing up to 65000 record to be held. Many features include versatile printing, powerful sorting routines, outputs can be compatible with Wordwise or View. **21.95 (a)**

BETABASE UTILITIES - Adds many more features to Betabase including full disc sort, mail merging and many more. **11.00 (a)**

REPLICA III - Now enhanced to transfer even more of your tapes to disc. Now uses a data disc so you need only to buy one copy. Even works with the BBC B+. **13.95 (a)**

BETA-ACCOUNTS - The first of this integrated suite of programs allows Invoices and Delivery notes to be issued. 80 Column editing, sales ledger sheet automatically generated, multiple VAT rates. Can be used with Betabase. **21.95 (a)**

PROFILE - A procedure library allowing up to 100 procedures on a disc, easy merging of procedures with basic programs. **11.00 (a)**

FONTWISE - A new font program allowing up to ten different fonts to be used with Wordwise or ascii text using an Epson compatible printer. **11.00 (a)**

FONTWISE PLUS - Enhanced version of the original Fontwise allowing more embedded commands. Now gives 12 fonts. **17.95 (a)**

WORDEASE - A utility disc for Wordwise-plus giving many new features to this best-selling wordprocessor. Includes label printing, disc menus, versatile copying routines etc. **Disc version 18.95 (a)**

SPELLCHECK III - A rom based spelling checker for both View and Wordwise. A dictionary of 76000 words is supplied which can be expanded to over 17000 on a 100k disc. Much faster than the original versions. **28.60 (b)**

TOOLKIT PLUS - An updated version of the popular Toolkit rom including a syntax checker and a full screen editor comparable to any other available. **36.65 (a)**

HELP II - Now extended to 16k, contains ALL basic keywords, ALL VDU codes, ALL FX codes. **28.95 (a)**

SLEUTH - A comprehensive basic debugging rom. It allows single stepping of basic programs, dual screen facility, breakpoints etc. **26.25 (a)**

EXMON II - A very advanced machine code monitor which now includes dual screen facility and a full screen memory editor. Also includes single stepping and breakpoints. **26.25 (a)**

MASTERFILE II - A general purpose file management package allowing large amounts of its information to be stored and processed. **17.50 (a)**

VIEW - Version 2.1 of Acorns wordprocessor. Allows 80 column editing, printing direct from memory etc. **44.45 (a)**

VIEW PRINTER DRIVER GENERATOR - Allows you to tailor a printer driver to your own printer. Comes with drivers for FX80, Juki 6100, Olivetti JP101 and others. **Disc - 11.00 (a)**
Cassette - 9.50 (a)

VIEW 3.0 - A version of View suitable for the BBC+. Comes with a cassette version of the Printer Driver Generator. **68.95 (a)**

HI-VIEW - A disc based version of this popular word processor for the 6502 second processor giving 47k of user memory. **44.95 (a)**

VIEWSHEET - Acorns spreadsheet rom giving 255 rows by 255 columns, multiple windows, works in any mode, wide use of function keys, fully compatible with View. **44.45 (a)**

VIEWSTORE - Acorns new database rom. Works in any screen mode, many powerful sorting facilities, can be spreadsheet or user defined card layout. max record size is 60k. Output can be sent to View and Viewsheets. Comes with comprehensive manual, utilities disc etc. **44.45 (a)**

VIEWSPELL - An automatic spelling checker using a dictionary of over 75,000 words. User dictionaries can also be created. **34.95 (a)**

VIEWPLOT - This rom will work with Viewsheets and Viewstore to draw bar graphs, line graphs and pie charts. (Available soon). **25.95 (a)**

GRAPHICS ROM - Acorns new 16k graphics rom giving many new commands for extensive graphics. Circles, ellipses, arcs, rectangles, parallelograms, segments and sectors etc are all available. Comes with manual and utility cassette. State B of B+ version. **25.95 (a)**

BASIC EDITOR - Acorns new editor rom allowing all the normal wordprocessor facilities to be used on basic programs. Features include block copy, block move and use of labels. **27.95 (a)**

TERMULATOR - A terminal emulation rom. Emulations provided are VT100, VT52, 4010, teletype, hardcopy and a special BBC terminal. Comes with user guide and a set of function key strips. **29.95 (a)**

ISO-PASCAL - A full implementation of the ISO standard supplied on two roms with two comprehensive guides. 6502 disc version also supplied. **54.95 (c)**

LOGO - A full implementation of the Logo language supplied on two roms. Comes with manuals, user guide, examples disc and reference card. **54.95 (c)**

COMAL - A full implementation of the International Standard for Comal. Comes with comprehensive manual. **44.95 (c)**

OXFORD PASCAL - A full implementation of the Pascal language including fully recursive procedures, type definitions and repeat until loops. Compiles down to compact P-code. **43.95 (a)**

AA189a



BRITISH BROADCASTING CORPORATION
MASTER SERIES MICROCOMPUTER



BRITISH BROADCASTING CORPORATION
MASTER SERIES MICROCOMPUTER



BRITISH BROADCASTING CORPORATION
MASTER SERIES MICROCOMPUTER

Order from Prestel
page no. 60043754

MASTER 128 – NOW AVAILABLE

Master 128	489.00 (s)
Turbo Upgrade	119.00 (c)
Master Econet Upgrade	47.00 (c)
Eprom Cartridges	14.95 (a)
Master Ref Manual Pt I	14.95 (a)
Master Ref Manual Pt II	14.95 (a)

Free with every Master sold, a disc based revolving diary showing 8 months ahead and 3 back. Allows many appointments each day and also permanent reminders to be kept. Runs from sideways ram and very easy to use.

KAGA TAXAN KP810

A top quality NLQ printer giving 150 c.p.s. draft and 27 c.p.s. NLQ. Fully FX80 compatible, friction and tractor feed as standard. Comes complete with cable and paper

249.00 (s)
Free with every KP810 the Font design package allowing 10 pre-defined fonts or any user defined fonts to be used.

EPSON LX80

The new low-cost printer from Epson giving 100 c.p.s. draft and 22 c.p.s. NLQ. Fully FX80 compatible. Friction feed standard, tractor unit available. Comes complete with cable & paper.

	225.00 (s)
LX80 Tractor Unit	21.00 (c)
LX80 Cut Sheet Feeder	56.95 (b)

JUKI 5510

A very versatile and fast printer giving 180 cps draft and 30 cps in NLQ mode. Friction & tractor feed as standard. Fully FX80 compatible. Comes with cable & paper.

	249.00 (s)
Juki 5510 Cut sheet feeder	235.00 (s)

JUKI 6100 DAISYWHEEL

A low cost daisywheel giving 20 cps 2k buffer 10, 12, 15 and proportional spacing. Cut sheet feeder and tractor unit available.

	275.00 (s)
Juki 6100 cut sheet feeder	189.00 (s)
Juki 6100 tractor unit	135.00 (s)

VIEW PRINTER DRIVERS

We have printer drivers available for all the above printers **7.95(a)**

FONT DESIGN

A disc based font program allowing any one of 10 pre-defined fonts or any pre-defined font to be downloaded to a Kaga KP810 or Canon PW1080A printer. The 8K ram chip (6264LP-15) must be fitted to the printer. BBC B, B+ and Master compatible. **9.95(a)**

AMX MOUSE

The mouse now comes with the new Super Art package. Now on a 16k rom it extends the original facilities to include Pull Down Menus, overlapping windows and extended icon sets. It is now compatible with Arias ram boards, the BBC B+, DFS and ADFS. The mouse and Super Art are available either separately or as a package.

AMX Mouse with Super Art	79.00 (c)
AMX Super Art	47.95 (b)
AMX Pagemaker	47.95 (b)

MASTER ACCESSORIES

View 3 guide	10.00 (a)
Viewsheet guide	10.00 (a)
Viewstore guide	10.00 (a)
Iso-pascal (C)	65.00 (a)
Logo (C)	65.00 (a)
Lisp (C)	56.00 (a)
(C)-Master cartridge	

DISCS

CDC 40tr s/s	13.95 (a)
CDC 40tr d/s	15.45 (a)
CDC 89tr s/s	16.95 (a)
CDC 80tr d/s	18.45 (a)
Maxell Twin Pack	
40tr d/s	4.50 (a)
Maxell MD-2DD 80tr d/s	22.00 (a)

BULK OFFER ON 5" DISCS (LIFETIME WARRANTY)

10 X 40TR D/S D/D	9.95 (a)
10 X 80TR D/S D/D	10.95 (a)
20 X 40TR D/S D/D	18.95 (b)
20 X 80TR D/S D/D	20.95 (b)
50 X 40TR D/S D/D	46.95 (c)
50 X 80TR D/S D/D	49.95 (c)

SPECIAL OFFERS

Hitachi Eproms & Rams – 250 nS

27128 16k Eprom	1-9	2.95 (a)
	10+	2.60 (b)
2764 8k Eprom	1-9	2.50 (a)
	10+	2.30 (b)
6264LP-15 Ram	1-9	3.50 (a)
	10+	3.00 (b)

Intel Chips

8271 controller		40.95 (a)
27256 32K Eprom	1-9	5.00 (a)
	10+	4.25 (b)

Acorn 8271 DFS	0.9	48.95 (a)
Acorn 8271 DNFS	1.2	68.95 (a)
Acorn 1770 DFS		48.95 (a)
Acorn ADFS		28.95 (a)

PROFIT

A complete integrated suite of business software for the BBC B (with shadow ram), BBC B+, Master 128 or KBL128PC. The system covers stock control, invoicing, credit notes, all ledgers, petty cash and bank account control and much more. **Only 97.00 (c)**

ARTIST

The new colour graphics package from Pear Tree using the ultimate mouse – Megamouse. This powerful art package allows all the normal facilities as well as sprites of any size, pattern editing and colour exclusion. The package comes complete with a manual, rom software, system discs and an Epson screen dump. The Artist package and the Megamouse can be bought separately or as a complete package.

Artist	53.00 (b)
Megamouse	65.00 (b)
Artist & Megamouse	97.00 (c)

DISC DRIVES

Mitsubishi (2yr warranty)	
80tr d/s single	124.95 (s)
80tr d/s dual	239.95 (s)
80tr d/s dual + psu	269.95 (s)
80tr d/s dual + psu in monitor stand	309.95 (s)

Cumana

80tr d/s single	154.95 (s)
80tr d/s dual	299.95 (s)
80tr d/s dual + psu	339.95 (s)

All drives come complete with manual, cables and formatting disc.

MONITORS

Microvitec 1451 Med Res	265.00 (s)
Microvitec 1441 High Res	435.00 (s)
Mitsubishi 1404 Med Res	265.00 (s)
Philips CF114 TV/Monitor	199.00 (s)
Kaga KX1201G Green Screen	103.00 (s)
Kaga KX1203G Amber Screen	120.00 (s)
Philips 7502 Green Screen	84.95 (s)
Philips 7522 Amber Screen	86.95 (s)
Philips 7542 White Screen	86.95 (s)
Hantarex HX12 18MHz Green Screen	79.50 (s)

All monitors come with a BBC cable.

ROM/RAM BOARDS

ATPL Rom board	37.95 (a)
Pear tree MR 2000 Rom board	13.95 (a)
Pear tree MR 3000 Rom board	17.25 (a)
Pear tree 4200 Rom board	29.95 (a)

WHERE TO FIND US

We have now settled in our new shop premises in the Essex village of Stansted. We have a host of software and hardware on display so why not come along and see for yourself.

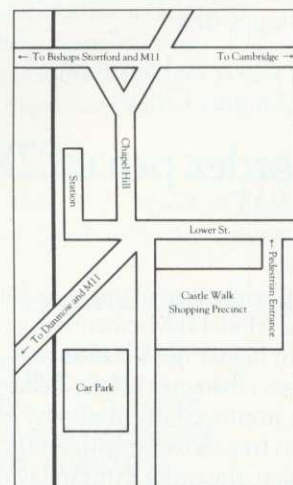

AA188B

ALL PRICES INCLUDE V.A.T. @ 15%
DEALER ENQUIRIES WELCOME

EDUCATIONAL AND GOVERNMENT ORDERS WELCOME

ALL ORDERS ARE DESPATCHED WITHIN 24 HOURS STOCK ALLOWING

PRICES SUBJECT TO CHANGE WITHOUT PRIOR NOTIFICATION

POSTAGE RATES –

(a) 75p (b) 1.25p (c) 2.00

(s) Securior £6.00 service



NEW MAIL ORDER RELEASES FROM TORCH COMPUTERS

NOW EVEN MORE POWER FOR YOUR BBC MICRO AT SPECIAL MAIL ORDER PRICES

Graduate II ▶

with updated motherboard and operating ROM for added IBM compatibility, speed and overall performance

- MS-DOS O/S 8088 16 bit processor
- Twin 360k disc drives
- 256k Ram
- Two hardware expansion slots

Mail order price £579 including VAT

Torch Unicorn ▶

- Multi-User, fully communicating, low cost UNIX computing
- 10 MHz 68000 plus 5 MHz Z80 processors
- 1024K RAM, 20MB hard disc, 400K floppy disk
- All the power and flexibility of UNIX for only £2870

Mail order price £2870 including VAT

The official range of upgrades for the BBC Model B Microcomputer now has an even higher specification and a price tag lower than ever before. Better O/S firmware, improved utilities, new user guides plus free software with all models.

Complete the order form today or telephone (0286) 5005 with your VISA/ACCESS card number. Torch Z80 owners send a cheque for 1986 upgrade pack, only £44.95 including VAT and P & P.

TORCH COMPUTERS 

Torch Computers Ltd., Mail Order Division, Cibyn Industrial Estate, Caernarfon, Gwynedd, North Wales LL55 2BD. Tel: (0286) 5005

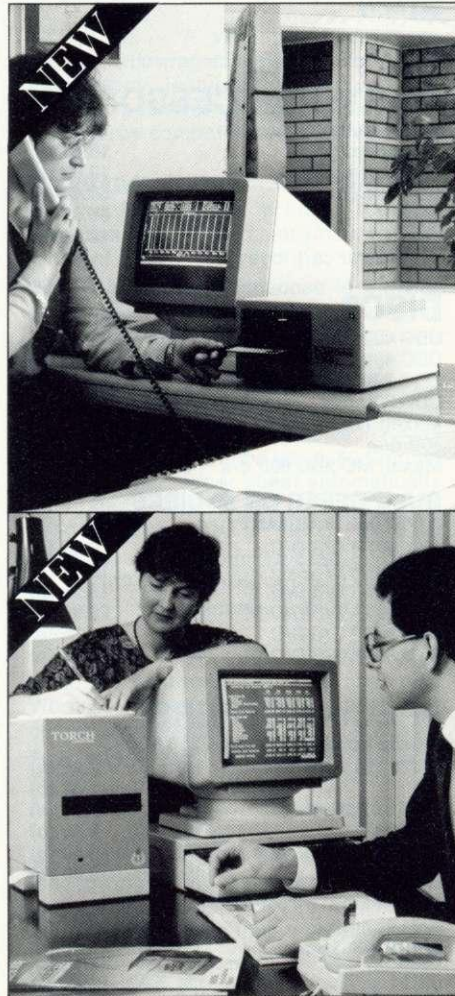

ZEP 100

Z80 extension processor
Free software and carry case.

Mail order price £229 including VAT

ZDP 240

Twin floppy discs and Z80 processor
Runs BBC-MOS and CP/M compatible software using high quality, double-sided 400K disc drives. Allows storage for BBC DFS and CP/M programs.

Mail order price £549 including VAT

HDP Z80

Hard disc, floppy disc and Z80 processor
Adds a massive 20 Mb of hard disc storage, ideal for small business and education environments.

Mail order price £1794 including VAT

To Torch Computers Ltd., Mail Order Division, Cibyn Industrial Estate, Caernarfon, Gwynedd, North Wales LL55 2BD.

Quantity		Unit Cost	Total	Please tick
Quantity _____	Graduate(s)	@ £579.00	£ _____	Model B <input type="checkbox"/>
Quantity _____	UNICORN(s)	@ £2870.00	£ _____	
Quantity _____	ZEP 100(s)	@ £229.00	£ _____	Model B + <input type="checkbox"/>
Quantity _____	ZDP 240(s)	@ £549.00	£ _____	
Quantity _____	HDP Z80(s)	@ £1,794.00	£ _____	Master <input type="checkbox"/>
Post and packaging £19.50 per order			£19.50	
Cheque enclosed for			TOTAL £ _____	

or charge my Access Visa

Card No.

Signature _____

Name _____

Address _____

Tel: _____

Allow 28 days for despatch of goods.

The Graduate is manufactured by Torch Computers under licence from Data Technologies Ltd. Product names referred to are trademarks of the companies of origin.

REVIEWS

SOFTWARE

INTRODUCE A NEW CAST OF CHARACTERS

If you want to improve your print quality – print everything twice.
Patrick Quick reviews some software which does just that

Fontwise allows you to use your Epson (or compatible) dot-matrix printer to produce Near Letter Quality (NLQ) print. It does this by printing two lines of graphics mode dots, slightly offset to fill in the gaps. A third pass is used when necessary to produce deep descenders and underlines. The software is supplied on a copy-protected disc which includes 10 font definition files. It prints directly from files produced by *Wordwise* (or *Wordwise Plus*) or from straight ASCII files.

Fontwise can justify and proportionally space and can do both at once. The choice of font, page layout, etc can be set up from the printing menu and can also be changed during printing by including embedded commands in your *Wordwise* file. Many of the embedded commands are the same as those of *Wordwise*.

The manual says that single, dual and quad density graphics are needed on your printer. However, I found that a trusty old Epson MX80 F/T III (with no quad graphics) performed perfectly well on standard print although it could not cope with condensed modes. The condensed modes are, in most cases, rather illegible anyway.

Fontwise can only be used with Basic 2: Basic 1 gives an error when you try to load a document. As *Acorn User* has carried articles showing how to emulate almost all Basic 2 facilities in Basic 1, there isn't much excuse for this shortcoming.

Paged documents in *Fontwise* don't have page headers at all and the footer is always a centred 'PAGE 1', etc. Paging without headers is a lot less useful.

Your printer *must* be switched to auto line feed. This limitation isn't necessary and I found it annoying. If Clares had read its Epson manual it would have found that line feed (ASCII 10) always ends a line correctly but Carriage Return (ASCII13) gives varying results depending on the auto line feed setting. To be fair, other NLQ software shares the same problem.

Fontwise is written to be used with *Wordwise* but they don't get on with each other terribly

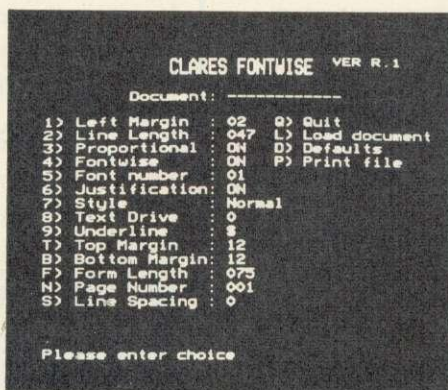

Layout etc is set up from the menu

well. If *Wordwise* is running when you re-boot to start *Fontwise*, strange things happen and you end up still in *Wordwise*. If you try to restart *Wordwise* after *Fontwise* has been used it locks up, even after CTRL-Break and you have to switch your machine off and on again.

It's not so easy to use the facilities of *Fontwise* from other wordprocessors: it does its own justification and line splitting, taking carriage returns as paragraph ends. For maximum flexibility you will also want to use the embedded commands, which is really only possible in *Wordwise*. As far as I can see, you

can't mix different fonts on the same line. The manual doesn't say you can't, but then it doesn't say you can and nowhere in the manual is there an example of a mixed line.

Fontwise can't be used over a network because it will only load text from drives 0 to 3. No OS commands are allowed, presumably to maintain copy protection.

In common with other NLQ systems, *Fontwise* produces fairly neat output which is easier to read than normal dot matrix mode but can't compare with daisywheel printing. It would be more useful for livening up the style of a school or club magazine than for business letters. The variety of fonts provided is good but more size options (eg, for headlines) and perhaps a font designer program would have added a lot to the package. Like other NLQ packages, *Fontwise* is slow because to the three passes for each line of print.

Finally, *Fontwise* is better than many NLQ packages and is reasonably priced, but don't forget that it needs Basic 2 and you can't take a backup copy.

Fontwise disc (40 or 80 track or 3"), £12 inc p&p and VAT: Clares Micro Supplies, 98 Middlewich Road, Northwich, Cheshire CW9 7DA. Tel: 0606 48511

Fontwise print sample (proportional)

Font 1 abcdefghijklmnopq ABCDE
Font 2 abcdefghijklmnopq ABCDE
Font 3 abcdefghijklmnopq ABCDE
Font 4 abcdefghijklmnopq ABCDE
Font 5 abcdefghijklmnopq ABCDE
Font 6 abcdefghijklmnopq ABCDE
Font 7 abcdefghijklmnopq ABCDE
Font 8 abcdefghijklmnopq ABCDE
Font 9 abcdefghijklmnopq ABCDE
Font 10 abcdefghijklmnopq ABCDE

Now condensed

Font 1 abcdefghijklmnopq ABCDE
Font 2 abcdefghijklmnopq ABCDE
Font 3 abcdefghijklmnopq ABCDE
Font 4 abcdefghijklmnopq ABCDE
Font 5 abcdefghijklmnopq ABCDE
Font 6 abcdefghijklmnopq ABCDE
Font 7 abcdefghijklmnopq ABCDE
Font 8 abcdefghijklmnopq ABCDE
Font 9 abcdefghijklmnopq ABCDE
Font 10 abcdefghijklmnopq ABCDE

Fontwise provides 10 fonts, all available as regular or condensed

BBC MASTER DUSTCOVERS £4.95

Made from stone-coloured nylon which has been coated with PU to which an anti-static inhibitor has been added. These fabric covers are attractively finished with brown piping and have the computer name Hot Foil printed over the keyboard. They are washable and may be ironed with a cool iron. Similar covers for BBC B.

TAILORED COVERS FOR OAK UNIVERSAL P.C. £8.50

A large selection of matching covers available for printers from £4.50 and monitors from £4.95.

BBD Computer Dustcovers

The Standish Centre

Cross Street

Standish, Wigan

Tel: 0257 422968



AA216

contex

BANK MANAGER Manage your personal accounts with ease. Enter cheques and receipts. Standing orders any frequency. Automatic date sequencing. Reconcile statements. Search, amend and delete. Unreconcile. Move forwards or backwards. Analyse expenditure. Forward cash flow forecast. Up to 36 simultaneous 'bank' (bank, credit cards etc) accounts, 9999 standing orders, 99 analysis categories, 12 actual and 12 budgets per category, over 4,000 postings on an 80k disc. Reports to screen or printer. Graphics. Foreign currency support. Password. File recovery. Auto exec file. Field editing. Itemised look ahead. Programmable report writer.

"Data entry is a delight, professional, excellent product" *Micro User April '86*

BBC B and B+ version, disc only **£17.50**

Master (and BBC+ 128) super-version, disc only **£21.50**

Optional 'business utilities' adding double entry trial balance report and programmable spreadsheet analysis report, either version, disc only **£10.00**

TYPING TUTOR Quickly learn to touch type. Recommended. For BBC, BBC+ & Master. **Cassette £9.50 Disc £11.50**

SPREADSHEET Mk V Models up to 1,000 cells, very easy to use, many facilities. For BBC, BBC+ and Master, disc only **£17.50**

ALL PRICES FULLY INCLUSIVE. FREE POSTAGE WITHIN UK (overseas add £2) disc orders please state if 40 or 80 track required. Fast delivery. Enquiries and Access credit card orders telephone **02303-347** or send cheque to

CONTEX COMPUTING, 15 WOODLANDS CLOSE, COPLÉ, BEDFORD MK44 3UE



AA230

NEW MICRO-MAILER

A LOW COST DISC BASED

PROFESSIONAL ACCOUNTING PROGRAM

For The BBC Computer

"Micro-Trader"

INTEGRATED SALES PURCHASE AND NOMINAL LEDGERS

Designed for business use by a business man. "Micro-Trader" Sales and Purchase Ledger Transactions are updated to the Nominal Ledger.

"Micro-Trader" offers full Sales and Purchase Ledger facilities including SALES INVOICE and STATEMENT PRINTING with a capacity of 450 accounts and 3000 transactions per month in each Ledger.

Normal Income, Expenditure, Assets, Liabilities & Journal Posting in the Nominal Ledger with full Reporting for individual accounts, Audit Trail, Trial Balance, Profit & Loss and Balance Sheet.

"MICRO-STOCK"

Stock Control program, fully integrated with "Micro-Trader". 4000 Stock Items with user defined Codes. Invoice and Credit Notes and Cash Sales routine. Full Stock Held Reports.

£95.00 + V.A.T.



NEW "MICRO-MAILER"

A Mailmerge program, fully integrated with "MICRO-TRADER" With a user Database.

£45.00 + V.A.T.



PHONE TODAY FOR A FREE FACT SHEET

MEADOW COMPUTERS

11, LONDON STREET, WHITCHURCH, HAMPSHIRE, RG28 7LH

Telephone: Whitchurch (025682) 2008

AMSTRAD

IBM PC & CLONES

BBC Z80

COMMODORE

CP/M

MICROPRO PRODUCTS

PC DOS

POCKET PROSTAR SUITE

Suite includes Pocket WordStar, Pocket CalcStar, and Pocket InfoStar (DataStar + ReportStar) — for the Amstrad PCW 8256/8512, 6128 (with 2 drives), BBC Z80 etc. For the independent ProStar Guide, add £16.

£149

- Pocket WordStar for word processing and mail merging.....**£49.95**
- Pocket CalcStar spreadsheet for calculations, projections and analysis.....**£39.95**
- Pocket InfoStar—DataStar database and ReportStar, the powerful report generator and sorting program.....**£69.50**
- Pocket SuperSort—a comprehensive sorting program.....**£49.95**

PC DOS MICROPRO SUITE

Includes Easy (WordStar-compatible word processor), CalcStar spreadsheet, + InfoStar database and report generator. There is complete file compatibility between CP/M & DOS versions.

£289

- Easy—MicroPro's WordStar-compatible, menu driven, easy-to-use word processor for IBM PC and clones.....**£139**
- CalcStar—spreadsheet for calculations, budgets, projections and analysis.....**£59**
- InfoStar—powerful and flexible database and report generator with sort routines: easy to start for complete beginners, great potential for experts.....**£115**
- InfoStar Plus—includes StarBurst menu generator for design of turnkey systems.....**£139**
- SuperSort—comprehensive sorting program.....**£69**

THE DYNAMICS OF PROSTAR — The comprehensive GUIDE TO MICROPRO SOFTWARE.....**£18.00**

FREE SOFTWARE HANDBOOK PLUS 70 PROGRAMS ON DISC

5.25" disks/book set

£35.00

3" disks/book set

£39.95

- CP/M and PC DOS/MS-DOS Editions available.
- A comprehensive selection of favourite Public Domain programs—with excellent documentation in the form of the Handbook
- Chapters on Family Fun, Directory Assistance, Useful Utilities, Libraries and Catalogues, Communications, and a Hacker's Toolbox.

CPM BASIC programs require Mallard or Microsoft Compatible BASIC
DOS BASIC programs require IBM BASIC or Compatible BASIC

Send Cheque (or VISA/ACCESS number) to:

DAVIS RUBIN ASSOCIATES LTD

1 Canonbourne, Weston sub Edge, Glos. GL55 6QH

VISA/ACCESS order: TEL (0386) 841181

All prices include VAT and Postage

* * * * * **SEND FOR OUR FULL LIST** * * * * *

BUSINESS

NEWS



Observer may supply Prestel

Talks are under way between *The Observer* and Prestel which may lead to the newspaper providing a full news service on the network.

Terry Bell, who handles the syndication of *Observer* material, said that a report on Micronet suggesting the deal was all but signed, was 'put out prematurely', but confirmed that negotiations were well advanced.

Prestel is thought to be keen to expand the news service that it offers. The *Observer* deal would provide a large quantity of up-to-the-minute reports from the newspaper's full team of journalists and correspondents.

Details of the service have yet to be thrashed out, but it is possible that it could include the weekly business reports produced by the newspaper.

The South Bank Show

The South Bank Polytechnic in London is running an Open Computing School as part of its Microcomputer Advisory Centre. Aimed at managers and office workers, it allows you to start at any time during the term and choose the number of hours you do each evening. The tuition covers all the important business packages, including spreadsheets, wordprocessors and Basic programming.

For details write to the Microcomputer Advisory Centre, Polytechnic of the South Bank, Borough Road, London SE1 0AA. Tel: 01-928 0482.

Here comes the 512

by Steve Mansfield

Master 512 upgrades are now in the shops and at a lower price than Acorn originally estimated. To help users through the software jungle Acorn is releasing a list of software compatible with the micro. And to beef up the business machine even more, Acorn looks set to release a version of Concurrent DOS for the M512.

The price of the 512 co-processor is £399, including bundled software and a mouse. This is £100 less than Acorn suggested when the Master series was first launched.

Not all normal Acorn dealers will be selling the machine, however. The 512 is going through selected dealers who are expected to give a high level of customer support, particularly when it comes to telling users which soft-

ware will run on the machine. To help, Acorn has produced a list, available on request from dealers or direct from the company.

Even so, the choice of software is bewildering. Peter Turnbull of Microbank – one of the first dealers to receive the 512 – suggests that potential buyers go to a dealer who also sells MS-DOS business machines, and who should have a wide range of software available to try. Alternatively, his company will try to obtain specific titles for customers.

Third party software

It is unlikely that Acorn will produce software for the machine itself, preferring to rely on third party suppliers. But it now looks almost certain that the company is to release Digital Research's Concurrent DOS for the Master.

Concurrent DOS allows up to four programs to be run simultaneously – memory permitting – with the user able to switch between them at any time. You could, for example, print out one wordprocessor document while editing another, or switch between a wordprocessor, spreadsheet and database.

The software is made by Digital Research and normally sells for around £250. No price has been fixed by Acorn, but there are suggestions that it will sell for between £100 and £200 – probably closer to the latter. The package should be available through dealers within the next couple of months.

For more details, contact Acorn on (0223) 214411.

See Bruce Smith's review of the Master 512 co-processor on page 153.

Two more modems

Newly released: two modems aimed at the business market, from by Miracle Technology and Pace.

The Miracle product (right) is a stripped-down version of their state-of-the-art WS3000 series. Known as the WS4000, the £150 modem offers full Hayes compatibility, auto-answer, auto-dial and a range of speeds.

The WS4000 can also be upgraded to give 1200 and 2400 baud full duplex, tone dialling and a host of other features.

Pace's product is actually a group of modems known as Series Four. The basic model includes 300 and 1200/75 baud options. Two further models are available allowing 1200 and 2400 full du-



plex operation, and the basic model can be upgraded.

Automatic mode selection, call monitoring, built-in LCD display, Hayes compatibility and microprocessor control are some of the more outstanding features.

For more details: Miracle Technology Ltd, St Peter's Street, Ipswich IP1 1XB. Tel: (0473) 216141. Pace Micro Technology, Juniper View, Allerton Road, Bradford BD15 7AG. Tel: (0274) 488211.

Bufferbox to take your calls

A new buffer allows people to send electronic messages straight to you without going through a mailbox system first. The Telepost Bufferbox incorporates a modem to answer incoming calls so that messages can be dumped in a buffer until you're ready to read them with your own micro.

Messages can be queued, and an LED display tells you when there's something in the buffer waiting to be read. The Bufferbox costs £620 – but with heavy use that could work out cheaper than a conventional mailbox.

Contact Telepost at 43 Howards Thicket, Gerrards Cross, Bucks SL9 7NU. Tel: (0753) 882028.

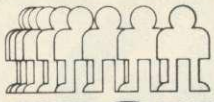

MICROMAN Computers

ACORN SPECIALIST COMPUTER CENTRE 
All our prices include VAT.

SUMMER SPECIALS

MITSUBISHI DISC DRIVES

OPUS 5802 400K 40/80T/DS
£119.95

OPUS 5802D 800K 40/80T/DS
£275.00

Opus Challenger 256K — £189.00

Opus Challenger 512K — £215.00

Floppy Discs DS/DD/80T 96TPI — £9.95

PANASONIC KX-P1080 PRINTER

This well-built printer offers many advanced features. It provides both friction and tractor feed NLQ as well as draft modes and full Epson code compatibility. This special offer includes a BBC Cable. Further details on request.

£189.00

CAD SYSTEMS & PLOTTERS

BITSTIK II — £799.00

ROLAND DXY880A — £799.00

APPOINTED WATFORD DEALER



Microman has been appointed a Watford Dealer. We will be stocking a large range of Watford products, including the popular BEEB DIGITIZER, MAGAZINE MAKER, 32K SHADOW RAM CARD, and many more available from our shop.

We stock the largest range in the North of BBC Peripherals, Disc Drives, Monitors, Printers, Expansion Boards, ROM Software, CAD Systems and Plotters. Call into our shop or phone/write for our full price list.

MAIL ORDER SALES

PHONE  
074488 5295

We accept both Access & Visa credit cards. Simply telephone your order, giving card number, expiry date, name and address, or send your order with cheque or postal order to FREEPOST MICROMAN at the address opposite.

Carriage/Postage Charges: Computers/Printers/Disc Drives: Next day delivery, £8.00; Royal Mail Trackback, £4.00; ROMS/Exp. Boards/Software: First class post, £1.00.

Our Mail Order Dept. will despatch your order within 24 hours (subject to availability).

All our prices include VAT.
Educational & Government orders accepted.

SHOP

Open 9-6 Monday to Saturday

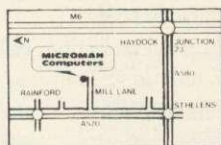

Rainford Industrial Estate,
Mill Lane, Rainford,
St. Helens, Merseyside.
Phone 074488 5242

Does your BBC have a one track mind?

True multi-tasking will put you out of your misery!

Your BBC now has the true multi-tasking potential of much bigger machines.

CMS Soft have cracked it! This module, packaged as a ready-to-fit sideways ROM, brings you a robust system that holds its own in the most demanding industrial and laboratory conditions.

And there is no interference with normal BASIC functions; Multi-Basic enhances the power, speed and readability of the best BASIC Interpreter there is.

£39⁹⁵ incl. p+p

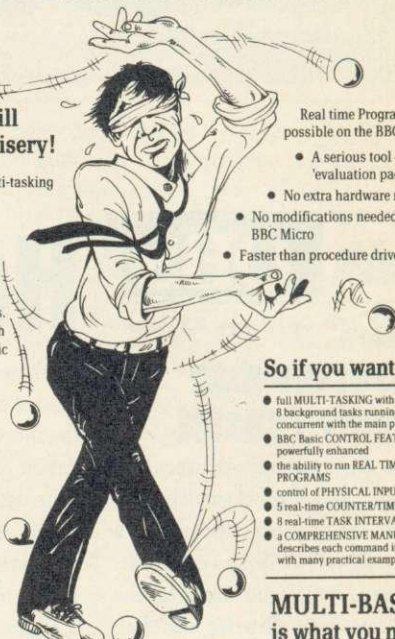
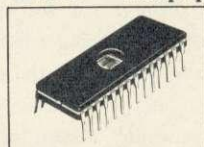

Real time Programs now possible on the BBC Micro.

- A serious tool – not an 'evaluation package'
- No extra hardware required
- No modifications needed to your BBC Micro
- Faster than procedure driven tasks

So if you want:

- full MULTI-TASKING with up to 8 background tasks running concurrent with the main program
- BBC Basic CONTROL FEATURES powerfully enhanced
- the ability to run REAL TIME PROGRAMS
- control of PHYSICAL INPUT/OUTPUT
- 5 real-time COUNTER/TIMERS
- 8 real-time TASK INTERVAL TIMERS
- a COMPREHENSIVE MANUAL that describes each command in detail, with many practical examples

MULTI-BASIC
is what you need



**MULTI
BASIC**

CMS Soft Limited.
Unit 18, Industrial Estate
Chelmsford Road, Great Dunmow
Essex CM6 1XG
Telephone (0223) 324141

CMS SOFT

* PORT EXPANDERS * (BBC B,B + ,Master)

The 1MHz Bus Driver provides full buffering of the bus and provides 6 outlets with a disable switch for each.

The 1MHz Bus Breakout box provides full buffering and is easily connected to a bread-board for hardware development.

The RS423 selector is a three way switch allowing one of three devices to be selected.

1MHz Bus Driver (6 Outlets)£39.95
1MHz Bus Breakout box£19.95
RS423 selector (3 way)£14.95

(Add £1.50 for postage and packing)

SWRX64 MINI ROM BOARD FOR ONLY £11.95 (+£1 P&P)

< Adds four extra ROM sockets to the BBC 'B' >

Also ribbon cables, BBC power cables made to your requirements. – write for quotation.

Please make cheques/postal orders payable to:

**COMPUTECH, The Garth, Hampfell Road,
Grange-over-Sands, Cumbria LA11 6BG**

For further details write or phone (04484) 4604.

AA207

NEW!! MASTER-ART for the BBC Master 128

Produce amazing graphics with this exciting new Art program specifically written for the MASTER 128. A new, very easy to use graphic tool for the artistic and fun for everyone!

Features

- *Uses all 64k of sideways ram
 - *Circle, ellipse, line, rubber banding, spray, radial line, square, inverse, Gcol, colours, text
 - *Input device; keyboard, mouse or trackball
 - *Easily create screens in Mode 2
 - *Menu driven – Pop up windows
 - *Scroll between screens in memory
 - *Switch between shadow and normal screen
 - *Copy and paste between screens
 - *Animation *Clock *Printout facility
- Double disc set 40 or 80 track DFS.
Please specify when ordering.
Send £25 inc. P&P to:

NUMBER 3 SOFTWARE
3 Dairy Farm Court
Attleborough NR17 2BT

AA281

BBC's discful of free software

Free software is on offer to users of BBC Soft's *Ultracalc 2* spreadsheet.

If you send a blank formatted disc, plus £2-worth of stamps to cover postage, you will get the disc back with a range of utilities, including a business graphics generator, to draw a variety of graphs from an *Ultracalc* file, and programs to include bold and underlined text in your spreadsheets, to draw and remove lines between columns and to import and export data between *Ultracalc* and other spreadsheets.

You can also download the files from OwlTel, BBC Soft's viewdata service, which your modem can reach on 01-927 5820. Snail mail users should send their discs to BBC Soft, 35 Marylebone High Street, London W1M 4AA.

3D spreadsheets

Cambridge Microsystems has launched a spreadsheet aimed at the business, scientific and higher education markets. *Matrix-3* runs on the Acorn Cambridge Workstation and Cambridge Co-processor systems.

It works in three dimensions with up to 10,000 rows and columns and up to 100 pages, plus all the facilities you would expect of an advanced spreadsheet.

Cambridge Microsystems, 137 Ditton Walk, Cambridge CB5 8QD. Tel: (0223) 214696.

Choose a card

The *Eureka!* card from Watford Electronics gives 14k more memory than a standard second processor for hi-versions of languages and applications like Basic, *View* and *Wordwise Plus*.

You also get two banks of sideways RAM and automatic shadow memory. The device plugs into the processor socket of a BBC micro.

New hard discs

by Steve Mansfield

In a new deluge of hard discs come three from Amcom and a low-cost unit from Acorn to complement its two existing drives.

Amcom has announced three hard disc drives with capacities of 10, 20 and 40 Megabytes. These range in price from £850 to £1400 (excluding VAT). They are compatible with any BBC micro running the ADFS, such as the Masters.

To back up the Winchester, Amcom has brought out a number of tape streamers. These provide a fast way of backing up large amounts of memory. A streamer for the Amcom hard discs costs £1200, while one designed for use with Acorn hard discs is £50 more.

Acorn's new drive is a 20M unit. Unlike the existing 10M and

30M drives, it is not being sold as a network fileserver, but rather as a stand-alone unit aimed squarely at Master owners.

The drive comes complete with various disc utilities, but not the fileserver software. That makes it possible for Acorn to bring the price down to £1085.

At the moment Acorn has no plans to market a tape streamer. Andrew Hinchley, Communications Products Manager, explained that he has 'never liked the reliability of what's on the market. As soon as we find a tape streamer that we are totally confident with, we'll go ahead and market it.'

Amcom can be contacted at 35 Carters Lane, Kiln Farm, Milton Keynes MK11 3HL. Tel: (0908) 569212. Acorn is at Fulbourn Road, Cherry Hinton, Cambridge CB1 4JN. Tel: (0223) 245200.



Hi-res monitor from Hantarex

A new green screen monitor - ideal for people who stare at spreadsheets and wordprocessors all day - has been launched by Hantarex.

The HX12 is a 12-inch model, with RGB, composite and audio inputs. The high resolution image is suitable for 80 column modes and has an anti-glare screen. The price is a fraction under £80.

More details are available from Hantarex (UK) Ltd, Unit 2, Lower Sydenham Trading Estate, Kangley Bridge Road, London SE26 5BA. Tel: 01-778 1414.

Artistes and accountants go Gold

Accountants and performing artists who want to keep in touch can now do so with new user groups on Telecom Gold.

The British Telecom service was chosen by the Institute of Chartered Accountants of England and Wales (ICAEW) as the host for a closed user group offering electronic mail, telex and information services. A subscription gives accountants full use of all of

Telecom Gold's services, including access to online databases such as World Reporter.

In addition, subscribers to the ICAEW network will have access to two special databases. The first is Pergamon Infoline's JordanWatch which carries financial data on around 60,000 UK companies. The other is Strathclyde University's AIMS News, with information on EEC and

Government assistance schemes.

The other new closed user group is Artslink for musicians and performing artists. Members include Sadler's Wells, the Scottish National Orchestra and leading agents. The service contains information on artists, agents and theatres.

Telecom Gold can be contacted at 60-68 St Thomas Street, London SE1. Tel: 01-403 6777.

BUSINESS TOP FIVE

	Title	Publisher	Cassette	Disc	ROM	Electron Shadow on B+	6502	Econet
1	Mini Office 2	Database	£14.95	*	—	—	Yes	No
2	View/View 3	Acornsoft	—	—	£89.70	No	*	Yes
3	Database	Gemini	£19.95	£23.95	—	No	*	No
4	Home Mate (Office Mate)	Gemini	£12.00	£12.00	—	Yes	Yes	No
5	Wordwise Plus	Computer Concepts	—	—	£56.35	—	—	Yes

Compiled by Gallup/MicroScope. *Contact publisher: Database Publications, Europa House, 68 Chester Road, Hazel Grove, Stockport SK7 5NY. Computer Concepts, Gaddesden Place, Hemel Hempstead, Herts HP2 6EX. (0442) 63933. Acornsoft, 645 Newmarket Road, Cambridge CB5 8PD. Tel: (0223) 214411. Gemini, Gemini House, Dinan Way, Exmouth EX8 4RS.

BUSINESS WORDS OF WISDOM

Our wordprocessing expert presents another bunch of handy hints, technical tips and verbal variations for users of *View* and *Wordwise*

Jacquetta Megarry

SHORTCUTS FOR STANDARD TEXT

Once you've been word processing for a while, you'll find that many of your documents fit certain patterns. You'll also probably have found that you have to type in an infuriating number of odds and ends every time you switch on. Here are two shortcuts that let the system take care of things automatically.

The first is sometimes called a 'template' or dummy file: an empty file that contains any format commands and/or standard text that

```
*FX22B,1
*TV0,1
MODE 3
*KEY1 Acorn UserIM141/
3 Drury LaneIMLondonIM
WC2B 5TFIMIM
*KEY2 Anything you wan
t key 2 to produce
*WORD
*.
```

Figure 1. Typical !BOOT file for *View*

you need regularly. For example, a correspondence template might contain your letterhead, the date and your signing off greetings. Load in the template before inserting your letter into the body of the document. This system not only saves time, but also guarantees that your work will maintain a standard appearance. Keep as many templates as you have standard documents that you use often.

The second shortcut is to create a 'boot' file to store your start-up commands. The disc system will search for a special file called !BOOT whenever you 'boot' that disc, ie, hold down Shift, press and release Break, then release Shift.

Although you can create !BOOT files in Basic using the *BUILD command, they're quicker and easier to write and edit within your wordprocessing system. Simply save your instructions giving !BOOT as the filename and then enter *OPT4,3 to 'enable' the !BOOT file. Copy the !BOOT file (repeating the *OPT4,3 to make it 'boot-able') on all future working discs. If you want to prepare a batch of blank but formatted working discs, simply

load the !BOOT file into your wordprocessor and save it to each disc in turn, not forgetting the *OPT4,3 command.

In the two examples (figures 1 and 2), type the commands as you would text, remembering to press Return at the end of *each* line

```
*TV255,1
*KEY1 !!!ds!"
*KEY2 !!!de!"
*KEY12 !!!oc27,45,1!"
*KEY13 !!!oc27,45,0!"
*WORDWISE
*.
```

Figure 2. *Wordwise* !BOOT file

including the last. Include any commands you need, such as *FX6 if your printer is set to ignore line feeds. You can program as many of the red function keys as you like, though you may need an extension to your keystrip to remember what you've put where.

The first !BOOT file is for *View*: you need *FX228,1 if you want to program function keys to produce strings. The second line makes the mode 3 rock-steady (by switching off the interlace) but it only works when you change mode so put this instruction *before* the Mode 3 command. The next line programs red key f1 with a useful address: press CTRL-Shift-f1 in Edit Mode and the address will emerge complete with new lines wherever there's a |M in the boot file (equivalent to pressing Return). You can program keys f0 to f9 in exactly the same way; see below for how to define Copy and the arrow keys. Finally, *WORD selects *View* and *. catalogues the disc.

Notes for Master users: (1) replace MODE 3 by MODE 131 to benefit from the extra memory (bytes free jumps from 12,542 to 28 926.), 2) you won't need the *TV0,1 as this is set as the start-up Configuration.

The *Wordwise* boot file's first line lowers the screen display by one line - handy if you're using a television screen for wordprocessing. Defining the red keys works as in *View*, but here I've employed them to store embedded commands. In 'recent *Wordwise*' (as I shall call *Wordwise Plus* and 1986 *Wordwise*), keys 1 and 2 are thus defined to switch on and off double-strike printing; 'old' *Wordwise* users replace ds by oc27,69 and de by oc27,70. Keys 12 and 13

are the left and right arrow keys; here they switch underlining on and off.

These two keys can be especially useful for defining any effect you need often, because, when they are pressed with CTRL, the cursor scoots neatly from word to word. ('Recent' *Wordwise* users can substitute *us* and *ue* for the oc codes, giving full preview of underlining effects on screen.)

You can also program the down and up arrow keys and Copy by numbering them 14, 15 and 11 respectively. Incidentally, you can use capital letters for embedded commands if you prefer, but be consistent: the red keys will produce *exactly* what you tell them to, in lower-case or capitals.

Personally, I use lower-case for all commands as it's quicker to type, but here I've shown commands like OPT, FX and |M in capitals to make them stand out. The only command that *needs* capitals is MODE 3.

FURTHER READING

Now, a word about some recent publications. *Word Processing on the Home Computer* is an independent user group with a readable magazine. It aims at Amstrad, Atari and BBC micro owners and contains interesting insights into how the systems differ. One year's membership (six issues) costs £6 from *Word Processing*, PO Box 67, Wolverhampton.

For anyone interested in professional typesetting from wordprocessor disc files, *Typesetting for Micro Users* is an invaluable companion. It helps newcomers to communicate effectively with typesetters, guides them through the concepts and activities and provides a wealth of useful examples.

The book includes model coding forms, an explanation of typesetting terms and an index. It costs £9.50 from Quorum Technical Services, Sandford Park Trading Estate, Cheltenham, GL52 6XH.

Finally, *View* users who have lost their manuals or are foxed by printer driver problems may like *Help Screens from View*. Although it presents the same information that can be found in the printed manuals, this friendly disc is easier to use, especially if you want to go

beyond bold and underlining printer effects or have a non-standard printer. However, you cannot call a help screen while in Edit Mode, and the disc adds a *fourth* (!) meaning for each function key. The disc is Master-compatible and costs £9.95 from Ceedsoft, 58 Saville Road, Blaby, Leicester.

DATE-STAMPING AND THE MASTER

Apologies to C G White, M J Skaife d'Ingerthorpe and other readers who found my May tip for accessing the Master's clock/calendar in *View* incomplete: press `!T` for time and `!D` for date in Edit Mode. What Acorn failed to tell me is that you *must* have an Edit Command in the left margin of the same line: press Shift-f8 and type something like LJ. Now `!T` or `!D` in your text will produce the time to the instant (uses, anyone?) or the current date (14 August 1986) when you preview (using SCREEN) or print.

It doesn't seem to matter which Edit Command you use, as long as there is one on that line. No-one at Acorn could explain why this facility had been provided and then had its usefulness restricted so much. *Wordwise* users can access the Master's clock/calendar after a fashion, too, using the operating system embedded command: *time in green will be replaced by the day, date and time all on a line of its own when you preview or print. Personally I can't find a use for this as I can't edit it, but perhaps someone out there can?

YOU CAN COUNT ON IT

Thanks to Bob Tennent of Glasgow for pointing out that *Wordwise Plus* users can execute a statement such as PRINT "0123456789" from a segment to number the first ten columns of preview screen: mark and copy these numbers seven times to number all 80 columns. If your system also does the *FX155 trick (see Colourful Grid Check, right), you can combine these to get something like a *Wordwise* 'ruler' as follows.

First, embed seg0 at the top of main text. Then select segment 0 and enter:

```
*FX155,n choose n as above/below
PRINT "01234..." 80 numbers
VDU14 optional
```

Enter these as text (*don't* embed them), followed by Return. Return to main text and preview: you should now have paged preview with overlaid numbered lines for checking 80-

column format. Leave these instructions in segment 0 and just remove the f1 (green) in front of seg0 if you want to cancel the effects.

To load this in automatically, first save whatever instructions you want as, say, PREVIEW. Then create (or add to) your !BOOT file as follows:

```
*wordwise
:select segment 0
:load text "PREVIEW"
:select text
```

Bob Tennent has also managed to insert screen dumps into *Wordwise* printout. Suppose you have a mode 1 picture saved on disc as a memory dump called PICTURE and want to dump it using a *Printmaster* ROM. Enter Segment 0 (or whatever segment is free) and type the following little program:

```
VDU22,1
*LOAD PICTURE
*GDUMP 0 0 2 1 20
VDU22,0
```

The first line puts the system into mode 1 (to match your picture) and the last restores mode 0 (for *Wordwise* preview). The second line loads in the picture and *GDUMP tells *Printmaster* how and where to dump the picture (substitute as appropriate if using a different screen dump program). Return to main text and embed seg0 at the place where you want the picture. By inserting a *WINDOW command before the *GDUMP, *Printmaster* users can control exactly which bit of the picture to use.

CONTROLLING SCROLLING

Many people have trouble with controlling scrolling, especially in long documents. You have to watch carefully for the bit you want, and if you miss it when it flashes past, you have to start again from the Menu. If you'd rather have the scrolling pause automatically, *Wordwise Plus* users can put VDU14 in a spare segment and embed a seg command to execute that instruction at the top of the document.

For example, if segment 0 is empty, just type in VDU14 (or vdu14) and enter embedded command seg0 at the top of your text. Now press Menu option 7 to see a 'paged' preview: press Shift to advance to the next 'page' - there is plenty of overlap. Take the seg0 command out of your document before printing it, though, or you'll keep having to press Shift to complete the printout.

Users of recent versions of *Wordwise* can control scrolling in preview mode by pressing the space bar to pause and almost any black key (not Break) to restart. If your *Wordwise* is an

older version, you must hold down Shift and CTRL together to pause and release either or both keys to restart. (*Wordwise Plus* users can use whichever method they like.)

COLOURFUL GRID CHECK

If you vary margins and line length or use a lot of tabs and indents, it's not easy to check the exact effects in *Wordwise* preview and you may have to resort to draft printouts. Thanks to Gary Crawford of Crawley Down for a neat tip for superimposing a grid of 80 vertical lines so you can count characters and can check the alignment on your preview screen. The effect depends on a *FX155,n call that uses a quirk of the ULA system in recent Bees and Masters - but won't work at all in older Bees: to test your machine, try *FX155,1 with or without text then press preview, or use Basic (enter MODE 0 first).

Within *Wordwise*, embed FX155,n at the top of your text using embedded command * or OS"" depending on which version of *Wordwise* you have. The number n controls both the colour and positioning of the lines. I'll explain this with examples, using the *Wordwise Plus* version. *FX155,1 produces a red grid, *FX155,2 a green grid and so on up to 15; if you really want flashing green and purple lines, try *FX155,10. (*Wordwise* users may need to use the form OS"FX155,1" instead, or may have too early a version for operating system commands at all.)

So far, these numbers all produce grid lines to the left of the characters so that if you've set lm10 you'll see a clear left margin of 10 columns with text beginning to the right. You may prefer to see each character centred on a vertical line; if so add 48 to each colour number. Thus *FX155,49 produces a different version of the red grid, *FX155,50 of the green, and so on. (Try adding 16 or 112 instead to see other positions.)

The effect won't work at all in 40-column preview (the kind you get with long documents unless you've Master or a memory expansion in a Beeb). But if it works on your system and you find it useful, experiment to find the colour and positioning of the lines which suits you best; this depends on your screen as well as whether you prefer to count lines or spaces. Then make a note of the command or, better still, include it in a !BOOT file (see above) on your working disc. The FX call doesn't affect your printout or editing in any way, so you need not remove it from a document unless you find it distracting.

ACORN FORUM

The 1770 disc controller chip is capable of more operations than your DFS ever dreamed of. Mike Barwise examines how to conduct a dialogue with the chip itself

In the July 86 issue, David Atherton covered the programming of the Western Digital 1770 disc controller chip, using the 'legal' OS commands. This month I am discussing programming it at the lowest level of control available to the user - direct dialogue with the chip itself. This is unnecessary in normal read/write circumstances, but the 1770 is capable of certain operations which are not implemented in the DFS, and which can be valuable.

The 1770 is in fact a very simple chip to drive. Its initially bewildering range of options can be reduced quite easily to a working set of commands which suit the hardware implementation in use, and the chips's architecture is extremely memorable and sensible. (In passing, it is worth noting that anyone using an independent FDC with a 1790 series or 2793 chip can directly transplant practically all of the following information.)

Drive select

The 1770 knows nothing about multiple drives: it is only aware of the drive currently selected by external hardware. As the drive select logic and the base address of the chip itself will vary depending on the machine you are using (BBC B with independent FDC, ditto with Acorn FDC, B+, Master) I would refer you to your technical manual and to David Atherton's article for details.

The 1770 performs the head positioning and data read and write operations on any currently selected disc surface. Each operation is independent, so a disc transfer typically consists of:

- 1 restore head to track 00
 - 2 read sectors 00 and 01 (catalogue)
 - 3 analyse file parameters
 - 4 seek to first track of file
 - 5 read (or write) sectors from first to either end of track or end of file if sooner
 - 6 if end of track but not end of file, step to next track
 - 7 repeat (5) and (6) to end of file unless error.
- It will be seen from above that there are two main kinds of operations the 1770 can perform: head movements and data transfers.

This division is visible throughout the 1770 command and status set, and allows a simplified device architecture, as the majority of control and status bits are dual tasking depending on the type of operation. This means that two separate error checking routines will be needed, one for head movements, the other for

Type	Command	Bits							
		7	6	5	4	3	2	1	0
I	Restore	0	0	0	0	h	V	r ₁	r ₀
I	Seek	0	0	0	1	h	V	r ₁	r ₀
I	Step	0	0	1	u	h	V	r ₁	r ₀
I	Step-in	0	1	0	u	h	V	r ₁	r ₀
I	Step-out	0	1	1	u	h	V	r ₁	r ₀
II	Read Sector	1	0	0	m	h	E	0	0
II	Write Sector	1	0	1	m	h	E	P	a ₀
III	Read Address	1	1	0	0	h	E	0	0
III	Read Track	1	1	1	0	h	E	0	0
III	Write Track	1	1	1	1	h	E	P	0
IV	Force Interrupt	1	1	0	1	I ₃	I ₂	I ₁	I ₀

Command summary

h = Motor On Flag (Bit 3) (1770 and 1772 only)

h = 0, Enable Spin-Up Sequence
h = 1, Disable Spin-Up Sequence

V = Verify Flag (Bit 2)

V = 0, No Verify
V = 1, Verify on Destination Track

r₁, r₀ = Stepping Rate (Bits 1,0)

r ₁	r ₀	WD1770-02	
		WD1773-02	WD1772-02
0	0	6 ms	2 ms
0	1	12 ms	3 ms
1	0	20 ms	5 ms
1	1	30 ms	6 ms

u = Update Flag (Bit 4)

u = 0, No Update
u = 1, Update Track Register

Flag summary

m = Multiple Sector Flag (Bit 4)

m = 0, Single Sector
m = 1, Multiple Sector

a₀ = Data Address Mark (Bit 0)

a₀ = 0, Write Normal Data Mark
a₀ = 1, Write Deleted Data Mark

E = 30ms Settling Delay (Bit 2)

E = 0, No Delay
E = 1, Add 30ms Delay

P = Write Precompensation (Bit 1)

P = 0, Enable Write Precomp
P = 1, Disable Write Precomp

Type II & III commands

data transfers, otherwise curious results will be returned. Western Digital in fact divides operations into four types. WD type 1 commands are the head movement operations, types 2 and 3 are data transfer operations, and type 4 is a single special command, Force interrupt.

Device architecture

The 1770 itself occupies four bytes of mapped in/out. All four are read/write locations, but the lowest is dual purpose. This is the Command register (write) and Status register (read). (Note that this distinction has nothing to do with disc read/disc write.)

The remaining three (in ascending order) are the Track register, the Sector register and the Data register. The first two behave just like static RAM, and the Data register is read from or written to during transfers on a byte-by-byte basis under the control of the BBC NMI.

The table (left) shows the function of each bit in each of the byte-wide 1770 op codes. The most significant three or four bits of each are fixed, and the rest are variable according to the detailed requirements of the current drive interface. You can now see the relevance of the division of the commands into two sets: the control bits are consistent in function within type 1 commands, and different but equally consistent in function within types 2 and 3. From type 4, the only really useful command is &D0, which is used to terminate an operation in progress and re-initialise the 1770.

Similarly the status register (table 2) contains certain bits which dual-task according to command type: bits 1, 2 and 5.

When experimenting with the 1770, it will probably pay to use all the 'safe' options: Enable Spin-up, Verify On Destination, Add Setting Delay.

The Update Track Register bit is used if you use Step to move between tracks, but it is equally valid to use Seek every time, and this automatically keeps the track register content correct. Single sector transfers are much easier to handle than multiple sector transfers, as the latter *always* terminate with a 'Sector not found' error on completion. Only normal data marks are used, and Write Precomp should not be used in single density. In double density, it should be enabled for all write operation to disc where the target sector is roughly in the innermost third of the data area - track 27 decimal onwards (40 track) and track 52 decimal for 80 track.

Driving the 1770

Let us look first at the basic mechanisms of 1770 operation. The first most important point is that (with the exception of the type 4 command) no command op code should be

ACORN FORUM

sent to the chip while it is busy (status bit 0 set). This bit should be tested before sent a command. Note that due to an architectural bug, is possible for this bit to remain set after a system reset. If you know you are *not* perform-

number. Seek will fail if you have selected too fast a step rate for your drive.

Step operates in a similar manner, except that no target parameter is needed, and the direction used is the last known direction.

Bit Name	Meaning
S7 MOTOR ON	This bit reflects the status of the Motor On output.
S6 WRITE PROTECT	On Read Record: not used. On Read Track: not used. On any Write: it indicates a Write Protect. This bit is reset when updated.
S5 RECORD TYPE/SPIN-UP	When set, this bit indicates that the Motor Spin-Up sequence has completed (6 revolutions) on Type 1 commands. Type 2 & 3 commands, this bit indicates record Type. 0 = Data Mark. 1 = Deleted Data Mark.
S4 RECORD NOT FOUND (RNF)	When set, it indicates that the desired track, sector or side were not found. This bit is reset when updated
S3 CRC ERROR	If S4 is set, an error is found in one or more ID fields; otherwise it indicates error in data field. This bit is reset when updated.
S2 LOST DATA/ TRACK 00	When set, it indicates the computer did not respond to DRQ in one byte time. This bit is <i>reset</i> to zero when updated. On Type 1 commands, this bit reflects the status of the TR00 signal.
S1 DATA REQUEST/ INDEX	This bit is a copy of the DRQ output. When set, it indicates the DR is full on a Read Operation or the DR is empty on a Write operation. This bit is reset to zero when updated. On Type 1 commands, this bit indicates the status of the IP signal.
S0 BUSY	When set, command is under execution. When reset, no command is under execution.

Status Register description (WD1770-02 and WD1772-02 only)

ing a disc operation, but Busy is still set, a Force interrupt (&D0) can sent at any time to the command register. This will clear the Busy status, but the currently selected drive will spin up. Unless the drive is ready (door closed, disc in place) the drive will remain spun up, as the 1770 looks for six index pulses before termination. A hard reset after the &D0 op cures this, but about 50 microsecs must elapse between sending the op code and the reset to allow the command to execute.

As soon as you are not Busy, the drive head should be Restored. This command retracts the head to track 00 and loads the Track register with zero. Note that every time you switch to a new surface, you must Restore. Restore does not require any parameters: track zero is implied. After Restore has terminated, status bit 2 should be examined to establish whether the operation was successful.

The next command is Seek. After your Restore, the Track register holds zero. To seek to a given track, you load the track number (remember that numbering starts at zero, not one) into the data register, and then send the Seek op code you have derived from table 1. Internal arithmetic is performed, and the direction and extent of the seek are automatically established. If Spin-up has been selected, the drive *must* be ready. Busy is monitored by polling until the operation is complete. If the Seek was successful, status bit 4 is clear (zero) and the Track register contains the target

Thus after a step out, the next step is also out and so on. Step in and Step out are used to change direction and also perform the *first* step in that direction.

Data transfer commands.

All read and write commands use parameters stored on disc at the time of formatting. The length of sector to be transferred is one of these parameters. However, the BBC DFS (most series and sources) expects a specific sector length of 256 bytes. Thus sectors of other lengths cannot be read by the DFS.

After a data transfer command is issued, the 1770 issues one NMI for each byte to be transferred. In single density, the NMI occurs at intervals of 64 microsecs, and at double density, at intervals of 32 microsecs. Note though that the NMI to byte transfer delay (your software run time) must not exceed 45 microsecs in single density or 22 microsecs in double density. These times are from issue of the NMI (not recognition of it) to effectively the start of the instruction after the read or write byte from/to the 1770. The NMI recognition time is generally about 7 microsecs.

Control is transferred to &D0 which normally contains an RTI, effectively masking the NMI. But before calling a data transfer command a 'JMP routine' should be installed there. 'Routine' is the entry point of suitable machine code in the user program. Bear in mind that you *must* save all registers on the

stack before doing anything else, and that a trivial 'idler' foreground task should be set up, to avoid the user program advancing during disc transfer. This last is a common fault, as you can inadvertently overwrite data while you are sending it to disc.

If you fail to service an NMI from the 1770 in due time, disc sector Write operation is terminated immediately, and status bit 2 is set. During a Read sector from disc, failure to service (lost data) does not terminate the command. The byte unserved is lost, but transfer continues to the end of the data field (sector). However, there will always be a CRC error as well as a Lost Data flag.

When using the Read sector and Write sector commands, the track is assumed to be already selected by a previous Seek or Step, and the user must load the required sector number into the Sector register before issuing the data transfer op code.

The Read Address command is useful for establishing two things: the current head position and the approximate format of the disc.

When the command is issued (no parameters), the 1770 looks for the first ID field it can find and transfers it to the micro. Six NMIs are generated: one for each byte of the ID. The bytes correspond to:

- 1 Track number
- 2 Side number
- 3 Sector number
- 4 Sector length code
- 5 & 6 CRC

CRC error is also indicated in the status register (bits 3 & 4).

The final commands are Read and Write Track. Write track primarily equals Format: there isn't space to go into formatting here, as the operation consists of setting down a complete track's worth of data including gaps, flags and embedded op codes for the 1770.

Read track, however, is a very useful command. This dumps the whole data stream (user data, gaps, headers, etc) straight to memory. There will be lots of data (more than 3.5k typically at single density), but corruption of ID headers and so on will not prevent access, so easily screwed discs can be recovered.

There will always be slight corruption of gap bytes, due to disc speed variations and so on during previous disc operations, but this should be clear by comparison with similar gaps in consecutive sectors. If you can find the damaged ID or whatever, the Write track can be used to restore the disc to perfection after corrections have been made.

See *AU* April and May for details of how to interpret the various parameters listed above.

DUAL DRIVES FOR LESS THAN £17?

Convert your single disc drives into duals for only £16.95 inc. VAT

- Specially designed circuitry eliminates the need for any tools
- No soldering
- Simply plug in for instant dualling
- No mess
- New improved longer cable reaching the back of the computer
- No need to take disc drives apart to change links

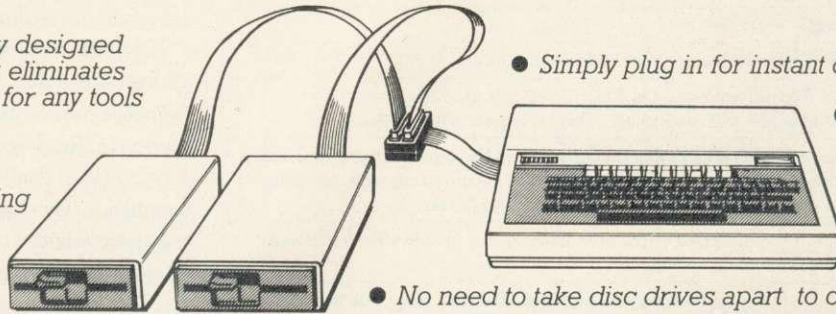

The Viglen DUCK (Dualling Up Connector Kit) can convert single drives to duals, instantly!

Just plug the **Viglen Duck** into the BBC micro and any two single disc drives to create a dual disc drive. Drives will be configured Drive 0 and Drive 1 automatically.

- Fast Back-Up
- Fast Copying of Files

The **Viglen Duck** will dual-up any make or type of single disc drives with PSU (power supply unit). It will also work on single and double-sided drives in any combination. If you have disc drives without built-in PSU, then you will require a dual power connector for the BBC micro - available from Viglen for only £8.00 inc VAT.

- Postage and packing £2.50 inc. VAT.
- Official Orders from Government and Educational Establishment welcomed.

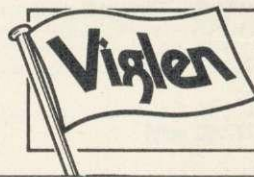

Orders to: Viglen Computer Supplies
Unit 7, Trumpers Way, Hanwell W7

Credit Card holders may order by
telephone: **01-843 9903**

All prices correct at time of going to press



YOUR ROMS WOULD BE HAPPIER IN A VIGLEN ROM CARTRIDGE SYSTEM

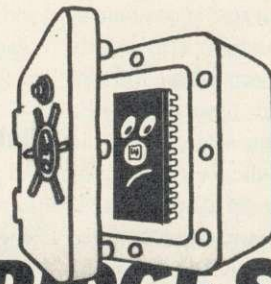

Tel: 01-843 9903
ACCESS/BARCLAYCARD
Credit Card holders can purchase by telephone. Please give Card No., Name, Address, and items required.

The safest way to look after your growing collection of ROMs is to store them in Viglen's specially designed cartridge systems, this not only keeps them happy, but also removes the risk of damage to your BBC micro.

There are two systems - the 'Standard' and the 'Low Profile'. Viglen is the leading producer of both.

ADVANTAGES OF VIGLEN ROM CARTRIDGE SYSTEM

- All cartridges are gold-plated for durability and reliability, unlike others which are only silver plated.
- No need to switch machine off between cartridge changes.
- Insert and remove 'Wordwise' 'View' 'Disc Doctor', etc., at will, from your micro in absolute safety.
- Low, low power consumption unlike other systems.
- Save on memory.

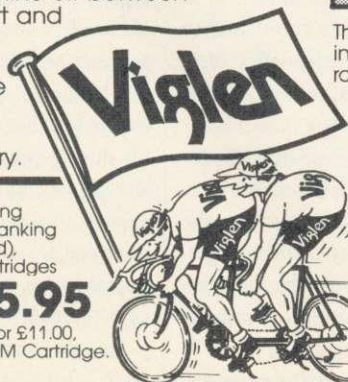

PRICE FOR COMPLETE KIT, including 1 cartridge, 1 Cable Assembly, 1 Blanking Off Plate (used if system is removed), 1 Socket Cover (used when no cartridges are resident), 1 Cartridge Storage Rack.

£15.95

Extra Cartridges: £2.95 each, four for £11.00, ten for £26.50. Kit comes with 1 ROM Cartridge. All prices inc. VAT.

THE STANDARD SYSTEM

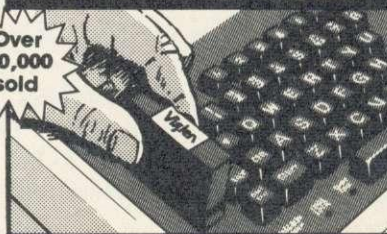

The Standard System used extensively in education is preferred, due to its robust construction and ease of use.

Personal Callers
Mon - Fri 9.30-5.30pm Sat 9.30-2pm

LOW PROFILE SYSTEM

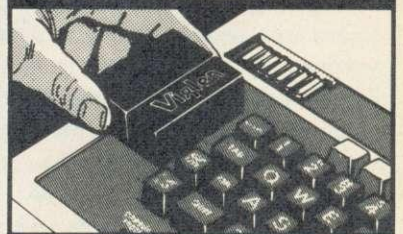

With the sideways entry on the low profile system access to the escape and tab keys are slightly restricted. However Viglen betters its rivals in this respect by being 3mm lower.

Post to: **VIGLEN Unit 7 Trumpers Way Hanwell W7 2QA**

Please send me (state type and quantity) _____ Kit(s) _____ Cartridges
I enclose Cheque/P.O. for £ _____ Please add £2.50 for postage and packing (50p only for single cartridge)

I prefer to pay by ACCESS/BARCLAYCARD * (Delete whichever is not applicable).

Card No. _____ Signature _____

Name _____ Address _____

Credit Cards valid if signed by Cardholder. Address must be the same as card holder's.



A VERY SPECIAL OFFER

from Viglen

PLEASE CALL
FOR LATEST
LOW PRICES

LATEST

The Superb Mitsubishi 400K Model M4853 Double-sided 40/80 Track Disc Drive



Other drives
available
from £89

Cased
with leads

Viglen

SWITCH
40 80

Track
switch
on rear
panel

At Viglen's rock bottom prices, everyone can afford to replace inefficient cassette tape units and obtain all the advantages of changing up to discs.

12 MONTH
WARRANTY
ON DISC
DRIVES
(Extended 2
year warranty
available)

£129
400K 40/80 TRACK
DISC DRIVE
INC. VAT

Latest Acorn 1770 DFS. Call at factory for free fitting. £49.95
Acorn ADFS ROM £29.95

Single Drives 40/80 400K

Single Drive	£129.00
Drive + Acorn DFS	£178.95
Integral PSU for single drive	£22.00

Dual Drives 40/80 800K

Dual drives	£258.00
Dual drive + Acorn DFS	£307.95
Integral PSU for Dual Drive	£28.00

All offers include

Utilities Disk includes formatting, verifying, BASIC program comparator, disassembler, Epson screen dump, dual catalogue (giving 62 files), large printing and many others.

Comprehensive Manual a fact-filled, 56 page document, includes techniques of loading from cassette to disk. Not available elsewhere



Carriage. Add £12 in each case. Usually despatched next day. Price covers courier-delivery and insurance. Prices include VAT.
Prices correct at time of going to press - Offer subject to availability.

Sales Hotline 01-843 9903

Please call for latest prices, product details and to place credit card orders. Government & Educational Establishments enquiries welcome on this number.



After Sales Line 01-571 6313

For dispatch enquiries, invoice queries, service and all other enquiries.

Call in at our Showroom

Weekdays:
9.30 - 5.30
Saturdays:
9.30 - 4

Post to: Viglen Computer Supplies, Unit 7, Trummers Way, Hanwell W7 2QA.
Please send me (specify all items)
I enclose Cheque/P.O. for £

Name _____
Address _____

I prefer to pay by ACCESS/BARCLAY CARD
Card No. _____

Signature
AU 9/3

The Great Little Printer from Viglen at a price everyone can afford

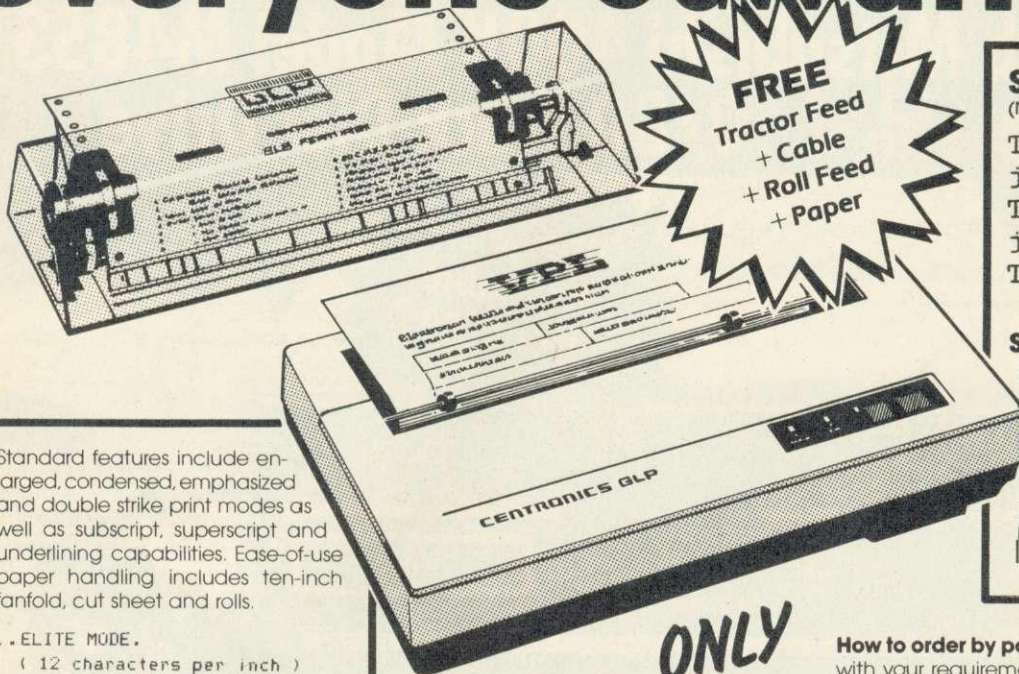

FREE
Tractor Feed
+ Cable
+ Roll Feed
+ Paper

SAMPLE OF NLQ
(NEAR LETTER QUALITY)

The quick brown fox jumps over the lazy dog
The quick brown fox jumps over the lazy dog
The quick brown fox jumps over the lazy dog

ACTUAL SIZE

SAMPLE USING EPSON SCREEN DUMP

NOT ACTUAL SIZE

Standard features include enlarged, condensed, emphasized and double strike print modes as well as subscript, superscript and underlining capabilities. Ease-of-use paper handling includes ten-inch fanfold, cut sheet and rolls.

1. ELITE MODE.
(12 characters per inch)
2. EMPHASIZED MODE.
3. DOUBLE STRIKE.
(Characters printed twice)
4. CONDENSED MODE. (17 characters per inch)
5. SUPERSCRIPIT CHARACTERS
6. SUPERSCRIPIT CHARACTERS CONDENSED
7. SUBSCRIPT CHARACTERS
8. SUBSCRIPT CHARACTERS CONDENSED
9. ITALIC CHARACTER SET.

ONLY
£124.95

INCLUDING VAT
Viglen Computer Supplies
Unit 7, Trumpers Way
Hanwell W7 2QA
Tel: 01-843 9903

Showroom/Factory open
Mon-Fri 9.30-5.30 and Sat 9.30-2.00

- All printers come standard with parallel interface
- 12cps Near Letter Quality
- Normal 50cps draft printing
- Separate tractor and friction feed
- Logic seeking head
- Uses normal A4 sheet paper or continuous stationery
- Original plus two copies
- 48 International characters
- Subscripts, superscripts and underlining
- Also available for IBM.



THE BEST PARTNERS FOR YOUR COMPUTERS

How to order by post - Simply fill in the coupon below with your requirements. Enclose your Cheque/P.O., or use Access/Barclaycard. Please make cheques payable to VIGLEN COMPUTER SUPPLIES and post to the address shown on the left. Remember to add £8.00 for p&p and insurance. Allow seven days for delivery.

Official Orders from Educational Establishments, Government Departments and Plc Companies accepted.

By telephone - Ring (01) 843 9903. Credit Card holders (Access/Barclaycard only) can purchase by telephone. Please give Card Number, Name, Address and items required.

Credit Cards valid only if signed by the card holder. Address on coupon must be same as card holder.



To: Viglen Computer Supplies
Unit 7, Trumpers Way, Hanwell, W7 2QA.

Please send me (qty) _____ GLP printer(s).

I enclose Cheque/P.O. for £
add £8.00 for carriage and insurance.

Tick whether BBC or IBM

Name

Address

.....

I prefer to pay by ACCESS/BARCLAYCARD
(delete as necessary). AU 9/4

Card No

Signature

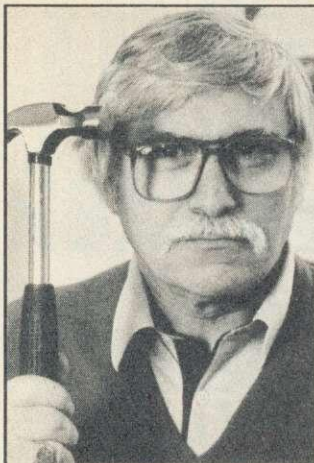

Snapper King turns nasty!

We advertised some months ago that our Harold had broken 2000 on Snapper and that he was going for 3000. Well he is still some 800 short of the target - and he's not very pleased about it. If you visit our shop to see our wide range of BBC hardware and software, just don't mention anything about Snapper. Look at our printers, keyboards and books by all means, but remember, Harold keeps the hammer behind the counter!

NUMBER ONE IN BROMLEY

Data Store

6 Chatterton Road, Bromley, Kent. 460 8991

AA53

SOLID STATE DESK TOP SWITCHING DEVICES

(FULL TWELVE MONTHS GUARANTEE)



The PARALLEL "PRINTERSHARER", "PRINTERCHANGER" & "PRINTERCROSSOVER" being solid state would allow use of much longer cables. We have successfully installed systems with up to 30M on input and output without data loss or errors

DON'T PUT UP WITH THE ODD MISSING OR WRONG CHARACTERS - USE KEYZONE SOLID STATE SWITCHES.

"PRINTERSHARER"
"SEVERAL MICROS TO 1 PRINTER"
OR
"PRINTERCHANGER"
"1 MICRO TO SEVERAL PRINTERS"

PARALLEL - 26 PIN (as BBC)
3 WAY (without cables) £60 (b)
3 WAY - with 3x2mt computer cables £75 (c)
6 WAY (without cables) £110 (c)
6 WAY - with 6x2mt computer cables £140 (c)
SERIAL RS232 3 WAY - £65 (b)
RS423 3 WAY - £40 (b)

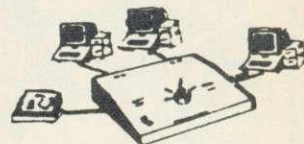

THE PRINTERCROSSOVERS
(2 MICROS TO 2 PRINTERS)
PARALLEL - 26 PIN £70 (c)
SERIAL RS232 £70 (b)
RS423 £45 (b)



PRICES ARE EXCLUDING VAT. Postage: (b)£2, (c)£2.50

CENTRONICS (36 PIN) PRINTERSHARERS, PRINTERCHANGER & PRINTERCROSSOVERS AND FOR IBM, SIRIUS, APRICOT, MACINTOSH, COMMODORE, 26 PIN APPLE II+, IIe & IIc AVAILABLE.

FOR PRICES AND LEAFLETS PLEASE CONTACT:

KEYZONE LTD
U14, REGENERATION HOUSE, SCHOOL ROAD,
PARK ROYAL, LONDON NW10 6TD.
Telephone: 01-965 1684/1804 Telex: 8813271



NEW!

from

Viglen

COMPUTER SUPPLIES

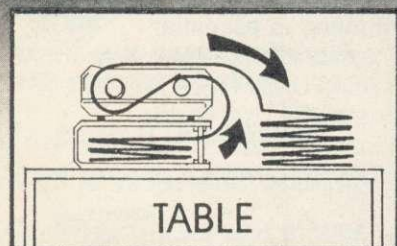

TABLE

Printer Stand

£16.95 INC. VAT

Carriage & Packing £3.00

A PRINTER STAND

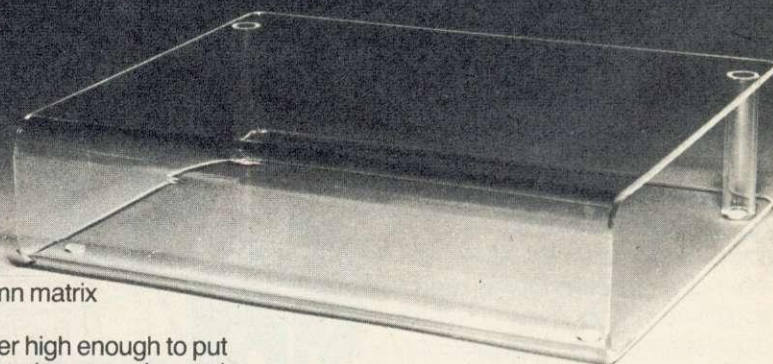

- For 80 column matrix printers
 - Raises printer high enough to put continuous stationery underneath
 - Beautifully finished in clear perspex • Viglen quality every time
 - Will accept paper up to 12½" wide • Non slip rubber pads
- Dimensions: 15" (380mm) wide (320mm) deep 4" (90mm) high
Also available 136 column stand @ £27 inc. VAT.

COME TO VIGLEN FOR A FAST, FRIENDLY, PERSONAL SERVICE

DEALER ENQUIRIES WELCOME

Orders welcomed from educational establishments and government departments

Prices subject to change without notice

Post to: VIGLEN COMPUTER SUPPLIES, UNIT 7, TRUMPERS WAY, HANWELL, LONDON W7 2QA.

AA63

Please send me _____ (qty) PRINTER STANDS at £19.95 each. I enclose Cheque/P.O. for £ _____ made out to

VIGLEN COMPUTER SUPPLIES or debit my ACCESS/BARCLAYCARD No. _____

Name _____ Signature _____

Address _____

AU 9/6

HELP FOR VIEW USERS

HELP SCREENS FOR ACORN SOFTWARE VIEW is a utility to help you, the user, obtain the benefits of the excellent VIEW wordprocessor. The commands and printer highlights are displayed on the command screen by pressing a function key. An example document is included for you to examine and print.

No more worries about line feeds or pound signs! Printer drivers are included for Epson compatible matrix printers: NLQ matrix drivers for Canon PW, Epson LX and Juki 5500, Star SG, Citizen C120D, and MP165. A special driver allows the Canon PW to switch between NLQ fonts. Daisy wheel printers supported are Quendata, Brother (with red ribbon switching) and Triumph Adler. These printer drivers allow (provided the printer does) Bold, Underline, Sub/Superscript, Enlarged/Shadow, Italic, and NLQ.

Experienced users have found that HELP SCREENS has added to their knowledge and novices have quickly become proficient users of VIEW.

Supplied on 40/80 track disc and tested with View 1.2, 2.1 and 3 for BBC B, B+ and MASTER. Price £10.50 including P&P. (Cheque/PO. No cash please.)

CEEDSOFT

58 SAVILLE ROAD, BLABY, LEICESTER LE8 3HQ.

Technical Enquiries 0533 773405 between 5.30 and 7.30 weekday evenings.

AA267

800K DUAL 5 1/4" DISK DRIVES

TWO 40/80 TRACK SWITCHABLE DRIVES: HORIZONTALLY HOUSED IN ATTRACTIVE STEEL MONITOR STAND COMPLETE WITH BUILT IN POWER SUPPLY. BBC Micro sits neatly underneath.



while stocks last

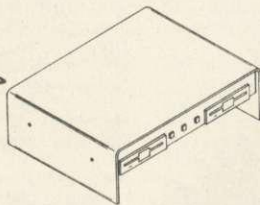

INCLUSIVE

QUEENSMERE LODGE

BRADWELL-ON-SEA: ESSEX: CM0 7HU: Tel: 0621 76320

Other drives available SAE or PHONE FOR DETAILS

AA280

ACORN USER ADVERTISEMENT PAGES - JUNE ISSUE

Doctrina Educational Software	140	Medstat	138
Acorn Computers	142	Micro Musical	138
ACP	6	Microaid	70
Akhter	12/13	Microchips	23
Alphadisc	136	Microfix	136
ATPL	46	Microman Computers	162
B & S Holdings	33	Micromedia	1
BBD	160	Microservice	22
Beebug	10	Microway	22
Britannia Computer Supplies	140	Microworld	99-101
C&F Associates	130	Minerva	31
Cambridge College	32	Morely Electronics	14
Cambridge University Press	140	Newark Video Centre	56
Care Electronics	98	No 1 Systems	33
Carey Electronics	31	No 3 Software	162
CED	IFC	Opus	26/84
Ceedsoft	174	Paul Fray	22
Centec	23	Peak Systems Design	33
CJE Micros	94	Pearl Computers	71-80
Clares	144	Peter Donn Software	32
CMS	134/162	Pineapple Software	138
Coastal tapes	32	PMS	52
Compshop	130	Printerland	23
Computech	162	Queensmere Lodge	174
Computer Concepts	20/21	RAB Enterprises	134
Contex Computing	160	Rickitt Educational Media	136
Control Telemetry	32	Rockfort Products	19
Crossware Products	140	Selec Software	130
Croydon Computer Centre	22	Silicon City	136
Cygnat	30	Soft-Teach Educational	30
Database Publications	87	Solidisk	24/25
Datastore	172	SP Electronics	174
Davis Rubin Associates	160	Speedysoft	132
Disking	27	Squirrels Byte	132
Dr Soft	132	Star Micronics	148/149
Edusoft	140	Starhelp	31
Event 1	98	Store Stock Systems	146
Flora Electronics	174	Storsoft	174
Galaset	8	Superior Software	BC/4/5
Griffen Computers	156/157	Scicom International	30
Ibthons Design Software	146	System	152
Innovative Software	23	Technomatic	34-42
Integrex	IBC	Torch Computers	158
Interface Electronics	56	Twilstar	28/29
IO Computer Communications	56	Twilstar	30/32
Jaysoft	46	Twilstar	150/168-172
Keyzone	172	Vign Computer Supplies	70
LCL	138	Vine Micros	90
Leewood Developments	22	Voltmace	58-69
Linear Graphics	16	Watford Electronics	56
Mancomp	146	We Serve	98
Matmos	56	We-Beastie	152
Mayday Software	136	Wild Vision	134
MB Software	23	WL Computer Services	22
Meadow Computing	160	Zonefour	

ALL IN STOCK

S. P. ELECTRONICS

BBC SPECIALISTS

BBC MASTER 128	£499.00
BBC Bs	£299
BBC Bs with disc interface	£350
CUMANA CD800S (800k) 2x80 track DS drive with PSU	£339
CUMANA CDX800S (800k) 2x80 track DS drive without PSU	£299
CPA 80 Printer (inc. cable)	£199.00
Disc Operating System	£96.00
Disc Drives	from £85.00
G3 WHO RTTY PROGRAM (TAPE)	£7.50
G3 WHO RTTY PROGRAM (EPROM VERSION)	£20.00
Circuit board for RTTY decoder Mk3 (inc. instructions)	£10.00
CANNON Dot Matrix 160cps NLO	£299.00
Joysticks (pair) self centring + analogue	from £17.95
Printer Cable (Centronics)	£12.90
Disc Doctor	£33.00
WORDWISE Word Processor	£33.00
Slow Scan TV Circuit Board + Program (inc instructions)	£17.50
ADFS	£29.90
1770 DFS Kit	£49.90
OPUS 800k drives 40/80	£199

Wide selection of software, books, leads, plugs, etc. All prices only SAE for full list. All available Mail Order while stocks last.

48 Linby Road, Huncknall, Notts. NG15 7TS
Tel: 0602 640377 (all prices include VAT)

Education & institutional orders welcome Carriage extra

MENU - MASTER

The USER FRIENDLY INTERFACE and DISC ORGANISING KIT for the BBC

Keeps your discs organised and usable with minimum effort. Select your programs and other items with a single key press. Menus easily installed on all your discs. Each can be customised for colour scheme, sideways ROM selection/control etc.

View or print information about menu entries at 3 levels. Works on model B (OS 1.0 or later), B+ or Master with Acorn or Watford DFS. Compatible with 6502 second processor.

For a fuller description send SAE for information sheet or read review on Viewfax Tubelink page 258216.

Send **£6.95** for disc (state 40 or 80 track) and manual.

Startsoft

2 Hillfields, Chelmsford Road
Hatfield Heath, BISHOPS
STORTFORD
Herts, CM22 7AX Tel: 0279 730590

AA268

DISCS

PRICES PER BOX OF 10 DISCS
ALL DISKETTES ARE GUARANTEED

5.25" Diskettes	40 TRACK		80 TRACK	
	SS/DD	DS/DD	SS/DD	DS/DD
STORAGE MASTER	£13.00	£15.00	£17.00	£20.00
NASHUA (Lib. Cased)	£13.50	£16.00	£17.50	£21.00
MAXELL	£15.00	£18.00	£18.00	£23.50
UNBRANDED	£ 8.00	£ 9.00	£10.00	£11.00

3.5" Diskettes, Storage Master, Nashua, Sony (Box of 10)	
SS/DD	£23.50
DS/DD	£33.50

HITACHI EPROMS	(BBC COMPATIBLE)		
2764-250ns	£2.25	4164-15	£1.00
27128-250ns	£3.00	41256-15	£3.75
27256-250ns	£5.00	50257-15	£5.00
27C256-250ns	£7.00	65C02CMOS	
6264LP-15	£3.50	Cpu 2Mhz	£9.00
		8271 FDC	£39.50
			£44.25

8271 + TL & CMOS CHIPS (Exc. DFSROM)

BULK PACKS

	25 Discs	50 Discs	LIBRARY CASES
5 1/4" SS/DD (48 TPI)	£17.50	£32.00	TO HOLD 10 DISCS
DS/DD (48TPI)	£21.00	£40.00	EACH -
DS/DD (96TPI)	£23.00	£44.00	ONLY £1.50

LISTING PAPER

11" x 9.5" microperforated Cogsm 2000 sheets £14.50 (inc £3.00 P&P)

NEW - 16K NON VOLATILE RAM MODULE. Very compact design. Same footprint as a ROM. Plugs into any sideways ROM socket. No soldering whatsoever. Guaranteed to run all ROM based software. Rechargeable battery contained in the module. Comes with write protect switch software on 5.25" disc. (40/80T).

£25.00 each

All prices include VAT & P & P

FLORA ELECTRONICS

14 LEVER STREET, PICCADILLY,
MANCHESTER M1 1LN
TEL: 061-228 3553

AA243A

SMALL ADS

■ **BBC B 05-DF5 1.2** + tape recorders + joystick + software + books £730, Torch Graduate 6 months never used + software £450, Canon half height D/D twin disc drive 40/80 + own power 800K £250, Z80 processor + software + reference books £230, will split. Main buyer gets books, software discs used only few hours. Tel: 0628-73905.

■ **Acorn Computers** and associated equipment WANTED. Best prices and instant decision. **For sale** computers and other hardware, tried and tested by enthusiasts, think of the other bits you can buy with the saving over new prices! **Redundant 5 1/4" DISCS** wanted 15p each. Discs tested and formatted to your requirements 50p each inc. p&p. Free delivery on hardware up to 20 miles, Securicor or fast post beyond. Don't delay Tel: Watlington (049161) 2349 today! 9am-7pm.

■ **BBC-B WORD-PROCESSING** at Amstrad price? New computer, disc drive, NLQ printer. Also TV/monitor, shadow-RAM view, includes *REVS*, *Aviator* discs. Originals all £600. Tel: 0865-723989.

■ **BBC model B, OS 1.2**, data recorder. Over £300 worth of software and utilities, also books and magazines accept £350 the lot. 021 422 6317.

■ **Student** with **BBC 6502** assembly skills interested in viewdata and electronics for holiday work. Write: Modicom, 22 Danbury St, Islington, London N1 01-359 0794

■ **27128** splitting consignment of 1000. Prices all inclusive 1-24 £2.86 25+ £2.54 Ifel 36 Upland Drive, Plymouth PL6 6BD. CWO.

■ **Upgrading to master?** We will buy your excellent condition BBC B whatever your reason for sale. Talk to Richard Beresford on 01-580 0055, office hours.

■ **Transfer 40-track discs**, to

80-track, using any 80-track drive and BBC B fitted with 8271 FDC. £4 to Mr B G Clay 26 Lower Crownest Drive, Lightcliffe, Halifax, HX3 8UN.

■ **Design multicoloured characters** on 16 x 16 grid. Lists VDU codes for inclusion in programs (eg animation). State 40T/80T/tape. £8.50 to Roger Pratap, Lawton Manor, Church Lawton. ST7 3DD.

■ **Personal Finance Planner** and Database. Proven system packed with features. Details and demonstration cassette £1 (refundable against purchase) or £6.95 for BBC/ELECTRON cassette. Vertexsoft 7, Beverley Gardens, St. Albans, Herts AL4 9BJ.

■ **Digit: Image Analysis** for BBC and Grafpad. Count objects, measure distances, thicknesses. Digitise shapes, measure perimeter, area, radius, volume, Feret diameters, C of G, shape factors. Edit, display and print results as histogram with mean and S.D. Uses: Quantitative Microscopy, Map Measurement, Metallurgy etc. 40 or 80 Track Disc and Instruction Manual. £70. For Grafpad2 (requires Grafpad utilities disc) or A3 Grafpad. Institute of Ophthalmology, Judd St, London, WC1H 9QS. Tel: 01-387 9621 Extn. 64.

■ **Convert your 80T Drive** to 40/80 switchable. MK II unit (cased) simply plugs in. £18.

MK I Kit as above but requires soldering iron - fits inside drive £10. Power supply unit for two disc drives, top quality, complete with plugs and leads £37. 8085 Assembler, two pass. Full instructions. Please state 40 or 80T. £35. All prices include p&p. Computer Repairs, competitive rates - please telephone for further information. Dept A7, Magus Electronics 33 Pool Lane, Winterley, Sandbach, Cheshire CW11 0RZ. Tel: (0270) 582748.

■ **Problems?** try R-SOFT utilities! 1. HOW-TO: An essential collection of software and instructions for frustrated new disc owners who want to move their programs to disc. 3. ROMPULL + TAPEDUMP. 4. AUTOMATIC DISC MENU: Includes sideways-RAM version, can boot from ROM, works with 2nd 6502. 6. SWROM*: puts your Basic/machinecode programs in ROM format. 7. RFS-GENERATOR: Generates ROMs for the *ROM filing system. This does not use DFS workspace and is an ideal tool to run nasty programs from disc. All above packages £5.00 each. 13. D-MASTER-V2: Superb disc backup program; needs 8271 and swRAM; £8.00; on 16K Eprom: £12.00. Upgrade for D-MASTER owners: £5.00/£9.00 16. OPUS SD/DD/CHALLENGER: Disc-Menu, Disc Editor, Disc Indexer, etc.

We must remind advertisers that we cannot carry advertisements which incite readers to break the protection and therefore copyright of commercial software

Please enquire for further details. 17. D-EDITOR: based on D-MASTER-V2: will edit any disc D-MASTER-V2 can backup! £8.00/£12.00 Please send sae for full list to R-SOFT, 22 Marriotts Close, Felmersham, Bedford MK43 7HD. Tel: (0234) 781730.

■ **Wordprocessing** printer routines providing maximum embellishment, even spacing achieved in justified mode including proportional text. Available for most daisywheel printers. Ribbons and printwheels competitively priced, eg Juki 6100 S/S £1.40, M/S £2.40, daisywheels £15.85, p&p extra. SAE details to New Horizon, PO Box 35, Plymouth, tel: (0752) 550700.

■ **Hackers Holy Grail** £12.50, subjects covered: telephone system, finding unlisted phone numbers, writing auto-dial software/listings, U.S.A. sources. Microchips 56 Waterloo Road, Southampton.

■ **Flip-over** function strip holder. Holds 10 strips in their own plastic sleeve. £5.25. With design software supplied on disc, £6.65. Eproms (27.28) £3.20. Computer Repairs, 2 Austins Place, Hemel Hempstead, Herts HP2 5HN. Tel: (0442) 217624.

SMALL AD SERVICE

Please include your cheque for £11.50 (inc. VAT) made payable to Redwood Publishing (please note: no POs; cheques only). This is the standard fee. Don't forget your name, address and phone number. Send cheque plus form to Acorn User Small Ads, 141-143 Drury Lane, London WC2B 5TF. Please print clearly.

ACORN USER'S

DIARY

The games people play...

Tynesoft is nothing if not topical. Following the company's coup in bringing out an Ian Botham game at the height of the drugs scandal, Tynesoft has again displayed its superb timing by bringing out a computer simulation of the Commonwealth Games.

We haven't seen the game yet, but it is rumoured that the program makes extensive use of the delete key, particularly when it comes to selecting teams.

Now we can exclusively reveal that another firm is trying to muscle in on this obviously lucrative area. Newkey Broonsoft's first attempt at topicality is a travel adventure program entitled *Geoffrey Howe's African Tour*. The object of the game is to travel through a mythical land meeting up with absolutely no interesting characters whatsoever.

A feature of the game is that whenever the program asks you a question you must avoid answering it directly. A straightforward reply will result in you being demoted to Minister of Public Conveniences, although you will, of course, put out a statement claiming it to be a promotion.

Dense is the word for it

Do you want twice as much memory from your micro? Well, one computer journalist obviously does. This poor deluded person, working for another BBC computer magazine (no names, our lawyers are getting nervous), recently rang the manufacturers of a disc filing system with a query.

The filing system in question allows single and double density

operation, and also allows you to use sideways RAM as a RAM disc. What the hack wanted to know was how to get double density storage in sideways RAM.

Perhaps the question isn't as silly as it seems. Perhaps the hack has found some wonderful new compaction technique for squeezing every byte into a nybble. Perhaps the BBC micro supports double density RAM and Acorn simply hasn't told anyone. Perhaps that was a pig that just flew past my window.

Val goes home

Valerie Holt, who until recently was burdened with the title 'Corporate Communications Manager' at Acorn, has left the company. The move is put down to 'pressure at home'.

However, Valerie, who once revelled in shouting matches with domineering publisher Robert Maxwell, was known to be frustrated at not being able to establish the same relationship with the passive Acorn boss Brian Long.

A loss to Acorn, one of the bastions of male computing.

Tea-leaf on the premises

Following reports of early-morning break-ins at the offices of Redwood Publishing, *Acorn User* sleuths have now traced the culprit. It turns out to be none other than our very own — until recently, that is — **Dear Kitty**. Although she left us for the illusion of fame and fortune at another company (see last month's diary), poor homesick Kitty has been coming back to make cups of tea. (They don't get a kettle at *Computing*.)

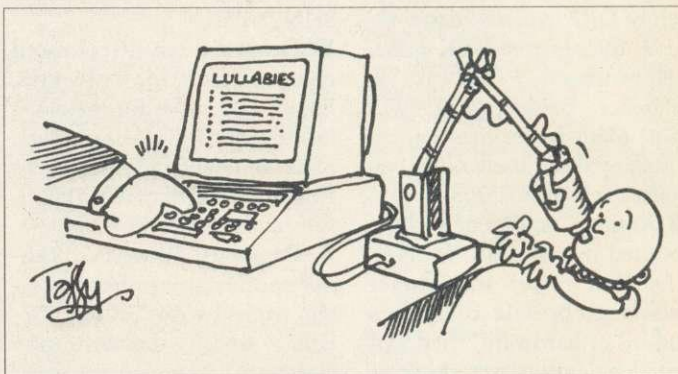

Fresh from the nursery

At last, the first picture of the new Baby Beeb. It's not quite what we were expecting, admittedly, but should provide welcome relief to harassed parents.

Special features on the new micro include a unique digital-to-gripe-water interface and a whole new range of operating system commands, such as *BURP, *CHANGE and *DUMMY. Other star commands have assumed new meanings with the BB. The most important of these are *INSERT (illustrated), *UNPLUG and the dreaded *DUMP.

The picture was supplied by the Reverend 'Taffy' Davies, a man of obvious humour and no mean skill with the pen.

Curry takes a powder

Gossip about a possible link between Chris Curry's sudden move away from Acorn and the announcement of Tynesoft's *Vindaloo* game appears to be unfounded.

Curry has sold his remaining shares in Acorn in order to devote his time to selling Acorn micros — well it must make some kind of sense to someone.

No mention has been made of any involvement by Curry in the games software market, so we have to assume that the appearance of *Vindaloo* is just one of the bizarre coincidences that you get in this crazy business.

The game is considered by the trade to be hot stuff, and should be running up the charts soon. Unfortunately, when we tried to contact Mr Curry for a comment he was indisposed.

Who cares?

The *Acorn User* offices have been swamped by an entry for last month's Knead-to-Know competition, where we asked you to guess the identity of an *AU* contributor from an early photograph. The entrant, one Nikolas Evanovitch, claims to know the mystery character personally.

Meanwhile, neighbours of the *AU* contributor in question have noted increased police activity around his house following the disappearance of his wife, Jill, who supplied us with the picture, and his sudden keen interest in gardening.

STOP PRESS: As we were going to press two more entries flooded in to the office. Paul Aston of Shepperton believes the knees to belong to John Cleese while El Smith of Dulwich thinks they are Jimmy Hill's. However neither of these two is famous for being an *AU* contributor.

COLOURJET

36 COLOUR INK JET PRINTER

NOW 132 CHARACTERS/LINE COMPRESSED

IBM pc compatible
including character set

Integrex specialises in custom hardware/software adaptations for OEM's etc, from simple 'badge engineering' to major code/character set changes plus special purpose internal interfaces

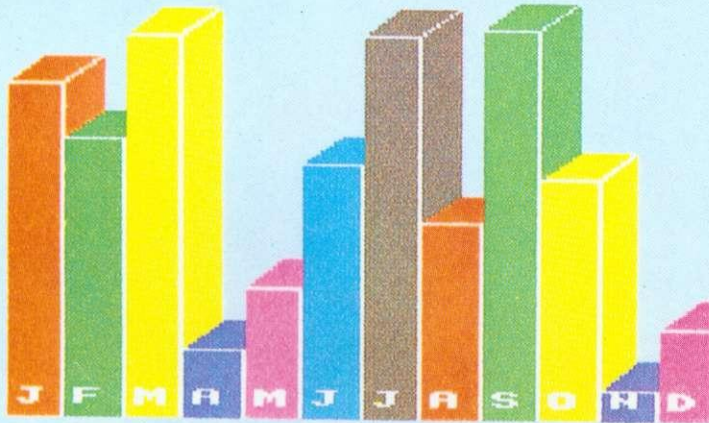

Standard options:

- RS232 interface, up to 16k buffer
- Serial videotex interface
- 125 colour BTX CEPT-3 interface
- 256k byte internal buffer
- IBM pc screen dump disc (all 16 lo. res. colours)

INTEGREX LTD.

Specifications:

- 640 dots/line and 1280 dots/line hi. res. mode.
- Up to 252 dots/inch resolution
- Videotex printing mode
- Centronics parallel interface
- Friction feed roll paper with single sheet feed A4.
- 40 cps in full colour
- Overhead transparency printing
- Ink cartridges, 4 million character life

RGB Frame
Grabber Compatible

Virtually
silent



INTEGREX LTD.

Church Gresley, Burton-on-Trent, Staffs DE11 9PT
Tel: 0283 215432 Telex: 377106

Dealers, OEM & Educational
enquiries welcome

ALREADY A NUMBER 1 BEST SELLER

COMPATIBLE WITH THE BBC B, B+ AND MASTER SERIES

THRUST

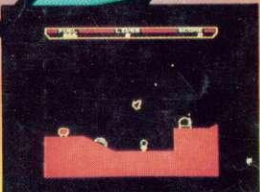

The first mission — destroy the reactor for a bonus score.



Retrieve the Pod and make your escape.

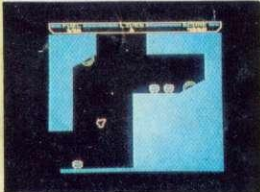

Collect the fuel and steer clear of the limpet guns.



Shoot the activator to open the sliding entrance door.



REVIEWS OF THRUST ALREADY PUBLISHED

Zzap! 64: "The most enjoyable game we've played for ages..."

— A ZZAP! SIZZLER.

Computer & Video Games: "Thrust is a simple but totally addictive game..." — A C+VG HIT!

Now available for the BBC Micro and Electron

The Commodore-64 version of Thrust (published by Firebird Software) shot immediately to No.1 in the software charts and was greeted with rave reviews throughout the computer press. Equally addictive and just as enjoyable, the BBC Micro and Electron versions of the game are set to emulate this performance.

Thrust is simple, fun-to-play, yet totally realistic and intensely challenging. Your mission is to visit 24 planets in turn collecting the Klystron Pods and, if possible, destroying each planet's reactor system. Your spaceship and the pods, which are heavier than the spaceship, move authentically subject to the laws of gravity, inertia and momentum — indeed the game's author, Jeremy Smith holds a First-Class Honours degree in Physics! Careful planning of your manoeuvres is essential in order to prevent the pods swinging out of control and dragging your spaceship to destruction.

To add to the challenge, the planets have different gravity rates and, as you progress through the game, some have "reverse gravity" or "invisible landscapes". They are defended by automatic limpet guns strategically placed to protect the pods and fuel tanks — the only source of replenishment for your limited fuel supply. The smooth screen-scrolling, which is exemplary, and the realistic action gives the player a fascinating feeling of floating through space.

PRICE: £7.95 (cassette), £11.95 (BBC disc)

COMPETITION COMPETITION COMPETITION COMPETITION

If you complete the mission by collecting the pods from all 24 planets, you can enter our competition. The prizes include the beautiful trophy (pictured on the right), £250 cash, and 3 copies of the captivating book "The New Atlas of the Universe" by Patrick Moore. Closing date: 31st January, 1987.



Dept. TH2, Regent House, Skinner Lane, Leeds LS7 1AX. Telephone: 0532 459453.



24 HOUR TELEPHONE ANSWERING SERVICE FOR ORDERS

- OUR GUARANTEE**
- All mail orders are despatched within 24 hours by first-class post.
 - Postage and packing is free.
 - Faulty cassettes and discs will be replaced immediately.



WE PAY TOP ROYALTIES FOR HIGH QUALITY SOFTWARE

Handwritten notes: (copy 1522 (M1 0201)) 6 CLEVER HILL

Handwritten note: bh

Handwritten note: HILL